



Cite this: *Environ. Sci.: Adv.*, 2025, 4, 1538

Thermophysical treatment technologies for chemical warfare agents sulfur mustard, sarin, and nerve agent VX – a review

Veera M. Boddu, *^a Justin Morales, ^a Mallikarjuna N. Nadagouda, ^{ab} Lukas Oudejans ^a and Lance Brooks ^a

Over the past few decades, technical advances have been made in the destruction of chemical warfare agents (CWAs) due to an enhanced understanding of reaction chemistries. This review focuses on summarizing the deactivation of the following CWAs: sulfur mustard (HD), sarin (GB), and nerve agent X (VX). This review includes multiple aspects of the agents, including chemical and physical properties, lethal doses, and common surrogates. However, the primary focus of the review is on various thermophysical approaches to deactivate these harmful chemical agents. Conventional deactivation technologies, including incineration and neutralization, are discussed along with advanced approaches, such as wet air oxidation, catalytic, and metal–organic frameworks (MOF) treatments. The review indicates that all three agents can be destroyed to nearly 100% Destruction and Removal Efficiency (DRE) with incineration, but at a high cost and with a significant energy demand, and only at secure, established facilities. Several countries have used incineration to reduce large volumes of CWA stockpiles. Other neutralization, wet air oxidation, and supercritical oxidation technologies are demonstrated at lab and pilot-scale levels to achieve 98–100% DRE depending on the operating conditions. Other relatively new technologies, such as catalytic deactivation and treatment using MOF, can achieve 70–100% efficiency but are still in the embryonic or laboratory development stage. Deactivation of CWAs with MOFs exhibit high degradation potential, reaching 100% DRE, but it may not be suitable for large volumes. Catalyst and MOF treatment may be ideal for deactivating small-volume CWA. However, further development and demonstrations are required.

Received 17th March 2025
Accepted 26th July 2025

DOI: 10.1039/d5va00071h

rsc.li/esadvances

Environmental significance

This literature review summarizes conventional and innovative treatment technologies for Chemical Warfare (CW) agents such as mustard gas (HD), sarin (GB), and nerve agent VX. Multiple aspects, such as chemical/physical properties, lethal doses, and simulants, are included. Deactivation technologies, such as incineration, neutralization and advanced techniques, such as wet air and catalytic oxidation are discussed. Newer methods, such as Metal–Organic Frameworks (MOF), can reach Destruction and Removal Efficiencies (DRE) of about 70–100% but are still in the early stage of development. This review helps remediation responders develop treatment technologies that minimize toxic residues and protect health and the environment. Developing environmentally benign technologies for safe deactivation and disposal of CW agents is a priority for environmental scientists and specialists.

1 Introduction

Chemical warfare agents (CWAs) are toxic and hazardous compounds that are intentionally produced and deployed during wars and used in clandestine activities.^{1,2} The First World War was the first to use CWAs, and it was internationally banned by the Geneva Convention in 1925. Friederich *et al.* (2017)³ summarize 100 years of chemical warfare research, development,

and consequences in a symposium publication. It covers the great scientific advancements and the dark side of mass killing tools. Lethal CWAs have not been produced since 1968; *e.g.*, 40 000 tons were produced in the US.² Additionally, the 1992 United Nations Chemical Weapons Convention Treaty prohibits the production, stockpiling, and large-scale deployment of chemical weapons and their precursors.⁴ National stockpiles of CWAs, primarily consisting of nerve, vesicant, and blistering agents, have deteriorated, requiring immediate attention for neutralization and disposal. More than 98 percent of the declared stockpiled chemical weapons worldwide have been destroyed.⁵

Despite the Chemical Weapons Convention Treaty, such compounds are still in use during warfare (*e.g.*, the use of sarin

^aCenter for Environmental Solutions and Emergency Response (CESER), Office of Research and Development, U.S. Environmental Protection Agency (ORD/USEPA), Research Triangle Park, NC, USA. E-mail: boddu2001@gmail.com; Tel: +1-919-541-3523, +1-309-966-3554

^bORD/USEPA, 26 West Martin Luther King Drive, Cincinnati, OH 45268, USA

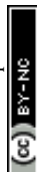

and mustard gas (mustard gas is a liquid at room temperature despite its name) against civilians in Syria⁶) and terrorist attacks

(e.g., the release of sarin gas in a subway system in Tokyo, Japan).⁷ Moreover, before the Chemical Weapons Convention Treaty, munitions and chemical weapons were dumped in the sea (e.g., containers of chemical weapons were released into the Baltic Sea).⁸ Alternative disposal methods, including open-pit burning and burial, pose long-term environmental and health risks (e.g., releasing toxic contaminants into soil, groundwater, and air).⁹ It provides both scientific information and various degradation methods have been employed to abate toxic warfare agents, including combustion technologies, hydrolysis, and oxidative chlorination.¹⁰ However, these methods are limited by high costs, high energy consumption, high reactant requirements (e.g., high volumes of degassing solutions), and secondary contamination (e.g., toxic gaseous derivatives that may require further treatment). A schematic illustration of the environmental and health risks associated with the



Veera M. Boddu

Dr Veera Boddu is a Senior Scientist with the Center for Environmental Solutions & Emergency Response of USEPA. Before joining the USEPA, he worked for the U.S. Army Corps of Engineers and the U.S. Department of Agriculture. His expertise encompasses environmental separations, advanced oxidation processes, air emissions control, wastewater treatment, sustainable materials from agricultural wastes, as well as carbon sequestration and waste minimization. He has co-authored approximately 90 peer-reviewed journal publications, over 100 conference and invited presentations, 18 Army Technical Reports, four books and five patents. He is a PE, a fellow of the AIChE, and a Board-Certified Environmental Engineer.



Justin Morales

Justin Morales is a mechanical engineer with a master's degree from NCSU and bachelor's degree from FSU. At the EPA, he researched various decontamination methods for airborne chemical and biological agents. At NASA, he researched manufacturing methods for multifunctional ceramic composites for space applications.



Mallikarjuna N. Nadagouda

Mallikarjuna N. Nadagouda earned his Ph.D. from India in 2003. He worked for General Electric (GE) in Bangalore before collaborating with Nobel Laureate Alan G. MacDiarmid at the University of Texas at Dallas. Dr Nadagouda later became an ORISE fellow at the EPA, eventually becoming a Physical Scientist at the EPA's CESER in Cincinnati. He is also an adjunct professor at Wright State University. His research includes PFAS, water treatment, nanomaterials, and drug delivery. He has received several EPA Scientific and Technological Achievement Awards, the ACS "Chemist of the Year" award, and has published nearly 250 papers with ~29,000 citations.

Dr Nadagouda later became an ORISE fellow at the EPA, eventually becoming a Physical Scientist at the EPA's CESER in Cincinnati. He is also an adjunct professor at Wright State University. His research includes PFAS, water



Lukas Oudejans

Dr Lukas Oudejans is a Research Physical Scientist with the US EPA Office of Research and Development's Center for Environmental Solutions and Emergency Response. Over the past 16 years, he has gained vast experience in homeland security programs related to research, development and evaluation of innovative technologies for the decontamination of materials contaminated with chemical or biological agents. Currently, he is leading research efforts to assess decontamination options for fentanyl analog contaminated building materials and approaches for effective decontamination of contaminated gear and PPE. Dr Oudejans holds a Ph.D. in Experimental Physics from Radboud University, Nijmegen, The Netherlands (1994).



Lance Brooks

For the Environmental Protection Agency, Mr Brooks leads a division for wide-area and infrastructure decontamination and landfill research. Previously at the Defense Threat Reduction Agency (DTRA), he led efforts with international partners to minimize the threat of deliberate, accidental, and natural infectious disease outbreaks through biosecurity, biosafety, and bio-surveillance measures. While with the Science and Technology Directorate of the Department of Homeland Security, he led research, development, testing, and evaluation in Chemical/Biological Detection as well as Attack Resiliency. He has previous experience as an analytical chemist conducting field-sampling, preparation of complex mixtures for bioassay, and quantitative analysis of environmental mutagens.

While with the Science and Technology Directorate of the Department of Homeland Security, he led research, development, testing, and evaluation in Chemical/Biological Detection as well as Attack Resiliency. He has previous experience as an analytical chemist conducting field-sampling, preparation of complex mixtures for bioassay, and quantitative analysis of environmental mutagens.



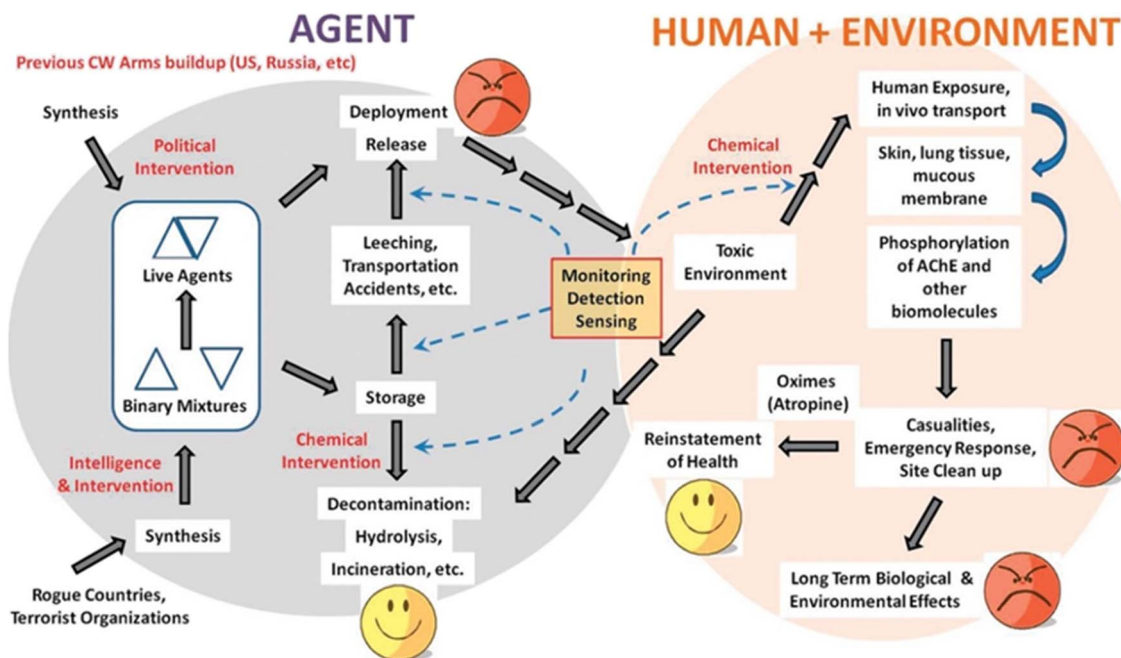

Fig. 1 Schematic illustration of the human and environmental impacts of the synthesis, storage, and deployment of CWAs. (Reprinted with permission,¹¹ Copyright 2011 American Chemical Society). (AChE: acetylcholine esterase).

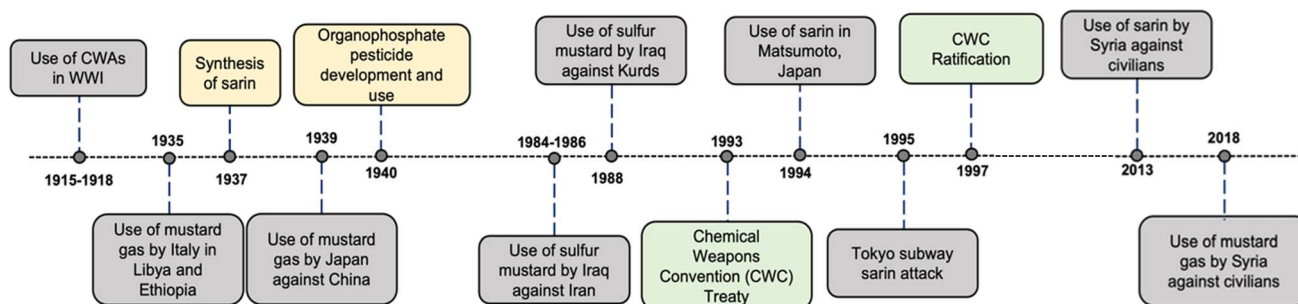

Fig. 2 Graphical timeline depicting historical events associated with the production and use of CWAs.

development, storage, and deployment of CWAs (*e.g.*, organophosphate-based) is shown in Fig. 1.

Historical events associated with the production and use of the selected CWAs are depicted in Fig. 2. A comprehensive description of the physiochemical and physiological properties, as well as the environmental and human health risks associated with these warfare agents is also discussed. Finally, an overview of conventional and state-of-the-art deactivation technologies (such as metal-organic frameworks (MOFs) and high-pressure process) methods is also discussed. These technologies operate at a wide range of pressures and temperatures (Fig. 3). The operating conditions of the treatment method are critical when selecting the optimal technology for a specific scenario.

1.1. Literature search approach

This rapid review focused on conventional and innovative treatment technologies for CWA agents: mustard gas (HD),

sarin (GB), and nerve agent VX (VX – venomous agent X). The objective was to summarize, compare, and identify knowledge gaps in the findings of treatment technologies, with a focus on articles published over the past decade. The articles were accepted or rejected based on the expected applicability of the information in the article, as determined by the titles and abstracts, relevance to the deactivation of CWAs, and the quality of the data included in the article. If accepted, the articles were then reviewed in detail for applicability and technical merit.

2 Chemical warfare agents

The literature search was conducted using the information in Table 1. While there are many treatment technologies, the search was limited to the technologies listed in the ‘Keywords’ below. The review also includes thermophysical properties and health effects of the CWAs.



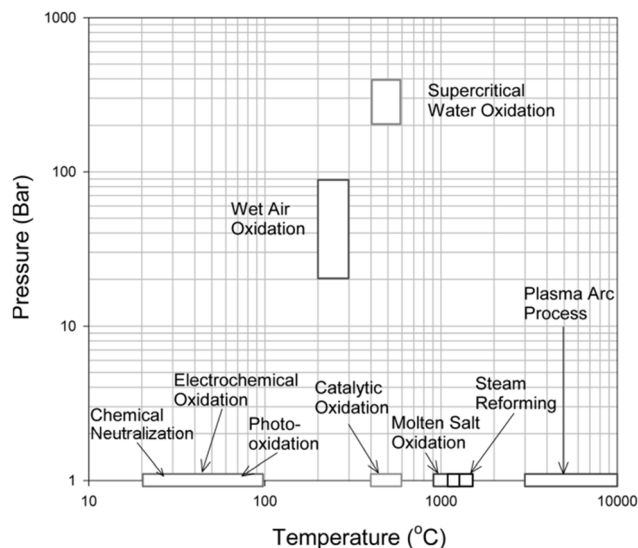

Fig. 3 Temperature and pressure ranges for various CWA destruction methods.¹²

2.1. Sulfur mustard (HD)

Sulfur mustard ($C_4H_8Cl_2S$), also known as mustard gas, is a blistering agent (*i.e.*, causes skin injuries) that was introduced during the First World War due to its ease of production and

odorless nature.¹³ Besides skin burns, depending on the degree of exposure, this blistering agent can cause severe eye injuries and chronic respiratory problems.¹⁴ Sulfur mustard (designated as “H” or “HD” by the military) can exist in various states, from an oily textured liquid at room temperature to a solid when the temperature is below 14 °C. However, it is essential to note that pure sulfur mustard is a colorless and odorless liquid. The actual CWA is impure, exhibiting mustard-like characteristics in terms of color and odor.¹⁵ HD can easily penetrate materials that would act as sinks and has a low water solubility (0.6 g L^{-1} at 10 °C); however, it is very soluble in organic solvents.¹³ Moreover, HD vapor is heavier than air, facilitating its sinkage to near-sea-level areas. The physicochemical properties, as well as the lethal dose for HD, are included in Table 2.

The primary routes of exposure to mustard gas are inhalation (*e.g.*, mustard gas released into the air), ingestion through drinking and eating, or direct dermal contact. Due to the high toxicity of this agent, simulants such as dibutyl sulfide and 2-chloroethyl ethyl sulfide (CEES) (Fig. 4) are used for research purposes.^{16–20}

Chemically, these nerve agents or organophosphorus compounds have a double-bonded $P=O$ and have substitutions of chlorine, fluorine, and sulfur atoms. These compounds interfere with the nerve transmission action of the enzyme acetylcholinesterase. These structural differences lead to their physical properties, such as volatility and persistence. G-series

Table 1 Literature search agents, keywords, topics, and resources

Chemical warfare agents	Keywords	Resources
Sulfur mustard (HD), surrogate: 2-chloroethyl ethyl sulfide (CEES); sarin (GB), surrogate: dimethyl methylphosphonate (DMMP); venemous nerve agent X (VX), surrogate: dimethyl 4-nitrophenyl phosphate (DMNP)	Wet air oxidation, supercritical water oxidation, neutralization, elimination, decontamination, destruction, thermocatalysis, metal-organic framework	Web of Science, Science Direct, PubMed, Elsevier, Springer, ResearchGate, Academia, Google Scholar

Table 2 Physical and toxicological characteristics of the selected blistering and nerve agents^{22,24,25}

Property	Sulfur mustard (HD)	Sarin (GB)	Nerve agent X (VX)
CAS #	505-60-2	107-44-8	50782-69-9
Molecular weight (g mol^{-1})	159.1	140.1	267.4
Liquid density (g cm^{-3})	1.27@20 °C	1.1@25 °C	1.01@20 °C
Vapor density (air = 1)	5.4	4.9	9.2
Melting point (°C)	13.5	−57	−51
Boiling point (°C)	228	147	295
Aqueous solubility	Nearly insoluble	Miscible	Slightly soluble
Hydrolysis ($t_{1/2}$)	8 min@25 °C	80 h@20 °C	60 h@22 °C
Volatility (mg m^{-3} at 25 °C)	610	22 000	12.7
LD ₅₀ (skin, mg kg^{-1}) ^{a,b}	100	24	0.04
LD ₅₀ (intravenous, mg kg^{-1}) ^b	0.2 (dog)	0.014	0.008
LD ₅₀ (oral, mg kg^{-1}) ^c	2.4 (rat)	0.10 (rat)	0.077 (rat)
LC ₅₀ (skin, mg min m^{-3}) ^b	10 000	12 000	6360
LC ₅₀ (respiratory, mg min m^{-3}) ^b	1500	100	36

^a LD₅₀ or “lethal dose” refers to the dose required to kill half of the tested population when given all at once. LC₅₀ or “lethal concentration” refers to the concentration required to kill half of the tested population when given over a specific time. All LC₅₀ and LD₅₀ values in the table are the estimated values for humans (unless otherwise stated). ^b US Dept. of the Army, 1974. ^c Sharma and Kakkar, 2013.²³



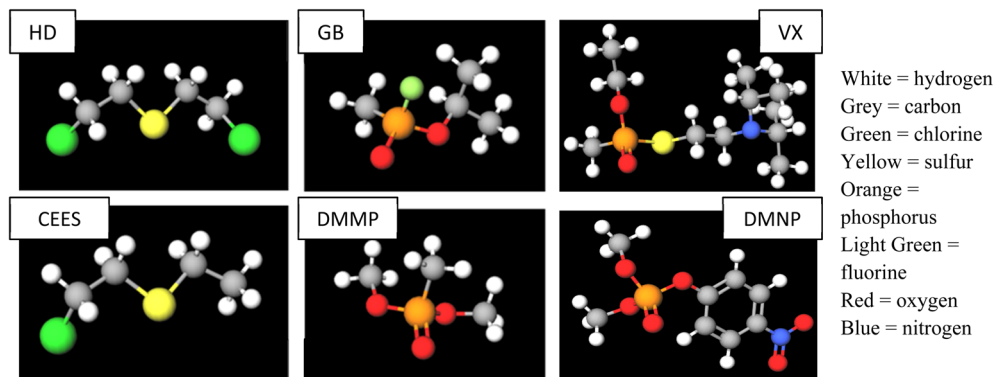

Fig. 4 Chemical structures of sulfur mustard, sarin, and nerve agent VX (top row) and their respective surrogates (bottom row).

compounds have higher volatility, while the VX has lower volatility and high persistence.

There is another class of mustard gases, nitrogen mustards, which are cytotoxic organic compounds. Nitrogen mustard has three variants (HN1: bis(2-chloroethyl)ethylamine, HN2: bis(2-chloroethyl)methylamine, and HN3: tris(2-chloroethyl)amine). These nitrogen mustards are strong blister agents, but those have never been used as warfare agents. These nitrogen mustards, however, are regulated and have found use in the synthesis of pharmaceutical compounds such as anticancer chemotherapeutic agents. This review does not include these nitrogen mustards.

2.2. Sarin (GB)

Sarin (also known as “German agent B, GB”) is a highly toxic organophosphate-based CWA. GB ($C_4H_{10}FO_2P$) is an odorless and colorless liquid that acts as a nerve agent that interferes with the function of a specific enzyme (*i.e.*, acetylcholinesterase), resulting in the hindrance of muscle contractions.²¹ The GB preparation process is similar to the manufacturing of toxic pesticides. Depending on the exposure dose, GB can cause death within a few minutes to hours.¹⁵ The primary routes of exposure are *via* inhalation and direct contact (*i.e.*, skin and eyes).

GB is highly soluble in water, as well as in organic solvents, including alcohols and esters, and in other warfare agents (*e.g.*, sulfur mustard).^{19,22} The same paper reports that partial decomposition occurs at its boiling point (*i.e.*, 147 °C). In addition, GB is highly volatile, allowing sarin vapors to adsorb onto porous materials (*e.g.*, concrete, wood, and brick). Dimethyl methylphosphonate (DMMP, Fig. 4) is typically used as a simulant for this nerve agent and other G-series nerve agents. The physical properties and lethal dose for GB are included in Table 2.

2.3. Nerve agent (VX)

Nerve agent VX (V stands for “venomous” in VX, $C_{11}H_{26}NO_2PS$) is a third-generation chemical warfare agent. More lethal than G-series agents with a median lethal dose (L_{Ct50}) of 15 mg min m^{-3} , VX shares similar exposure pathways and health effects with G-agents such as Tabun. Like G-series nerve agents, VX is an organophosphate compound. Its

development began as an attempt by industrial chemists to create a new pesticide, and it was later weaponized in England during the 1950s. The primary routes of exposure to VX are similar to those of the G-series nerve agents, including inhalation, ingestion, injection, skin contact, and eye contact. Symptoms can manifest within seconds and vary based on the dosage and route of exposure.

The health effects of VX are akin to those of G-series nerve agents. Common symptoms include mental status changes, fasciculations, muscle weakness, paralysis, increased secretions, miosis, shallow breathing, convulsions, coma, and respiratory arrest. Dimethyl 4-nitrophenyl phosphate (DMNP), like VX, is an organophosphate compound. Its lower toxicity and structural similarity make it a suitable surrogate for organophosphate nerve agents, including VX, in various studies and experiments.²³

3 Conventional deactivation methods for CWAs

3.1. Incineration

In 1984, the National Research Council (NRC) endorsed incineration as an effective method to destroy stockpiled CWAs, primarily nerve and blister agents.¹¹ With the first-generation baseline technology, stockpiles were subjected to a single burn. However, to optimize combustion performance, the second-generation incineration process consisted of three stages: (1) categorizing materials before combustion (*i.e.*, separation of CWAs, explosives, and other material); (2) incineration of CWAs, explosives, and other related materials (*e.g.*, storage containers); and (3) identifying and monitoring combustion products as well as disposing of liquid and solid wastes.²⁶ Briefly, the method involves liquid CWAs, including mustard gas and sarin, which are subjected to a two-step combustion process at a temperature of 1480 °C, maintained using a secondary fuel (*e.g.*, natural gas). CWAs were sprayed and mixed with air, and the resulting products were sent to an afterburner (maintained at a high temperature above 1090 °C). The final stage is a pollution abatement system to treat afterburner gases. Eqn (1) and (2) describe the incineration process for mustard gas and sarin, respectively.²⁷



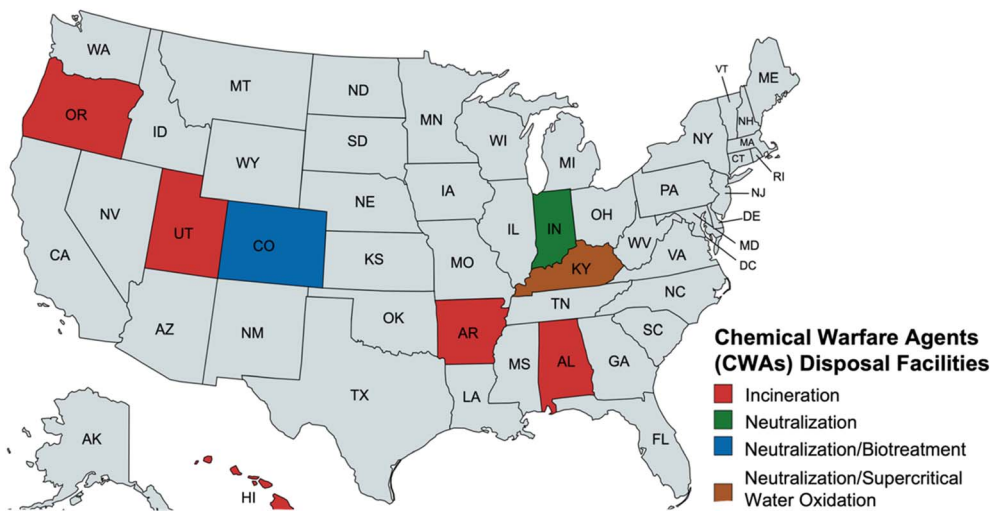
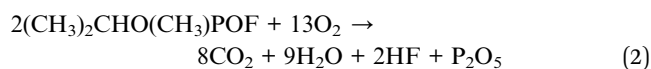
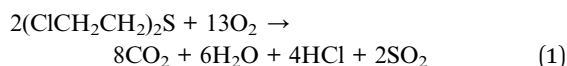

Fig. 5 US chemical agents' disposal sites (data obtained from the National Center for Environmental Health, Division of Environmental Health Science and Practice). The Blue Grass Chemical Plant in Kentucky, and the Pueblo Chemical Depot in Colorado remain the only active destruction sites. Decontamination and demolition of these sites will be completed in 2026.^{32,33}



While incineration effectively degrades most CWAs, the negative environmental impact (*i.e.*, high energy requirement) and public health risk (*e.g.*, exposure to secondary emission byproducts) associated with this technology warrant alternative methods.

3.2. Neutralization

The electrophilic behavior of most CWAs plays a vital role in determining their fate in environmental matrices. These agents undergo hydrolysis when they come in contact with water, resulting in polar products. It is important to note that most products are less toxic than the parent agent.²⁸ The higher solubility of the CWA (*e.g.*, sarin) makes it more susceptible to hydrolysis. In aqueous systems, sarin undergoes hydrolysis, forming isopropyl methyl phosphonic acid (IMPA), which can undergo further hydrolysis (at a slower rate) to methyl phosphonic acid (MPA) as shown in eqn (3).

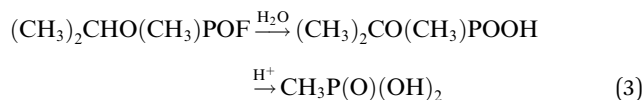

Nevertheless, most studies have reported that IMPA and HF are the only products formed during GB hydrolysis, resulting from the cleavage of the P–F bond. Operating conditions, primarily pH and temperature, highly impact the formation of hydrolytic products. Kingery and Allen, 1995 (ref. 29) reported that a minimum rate of hydrolysis can occur at a pH range of 4.5–6, with an increasing rate at higher pH. Another study

reported a half-life of 3 seconds for GB at a high pH of 12 (Dival, 2018).²⁸ Ward *et al.*, 1990 (ref. 30) reported that IMPA can be converted to MPA in water under acidic conditions (*i.e.*, pH = 3) and at high temperatures (*i.e.*, 169 °C).

In practice, the US Army mixed sarin with an 18% sodium hydroxide solution to generate a solution of inorganic salts and organic products, which were then classified as hazardous waste and sent to landfills.³¹ The generated water vapor was subjected to a scrubbing process, and the wastewater was discharged into a lagoon. Fig. 5 is a map showing the locations of former active sites of chemical agent destruction in the US, as well as two active sites in Colorado and Kentucky along with the implemented technologies. Fig. 6 illustrates conventional deactivation chemical reactions for sulfur mustard and sarin.

4 Deactivation technologies for CWAs

4.1. High-pressure treatments

Hydrothermal oxidation treatments require less energy because they operate at lower temperatures than incineration and combustion methods. Wet air oxidation (WAO) methods consist of temperatures between 200 and 330 °C and pressures between 20 and 200 bars.³⁴ Treatments above this temperature and pressure are considered supercritical wet oxidation (SCWO) methods, typically ranging from 400 to 650 °C and 250 to 350 bars.^{35,36} As a reference, oxidation in supercritical water occurs at temperatures above the critical temperature of water (*i.e.*, 374 °C) and critical pressure (*i.e.*, 217 atm). A schematic illustration of the wet oxidation treatment is shown in Fig. 7. Lee *et al.* (2005)¹² have studied the decomposition of DMMP in supercritical water in a continuous-flow tubular reactor. It was found that total organic carbon (TOC) conversion exceeded 99.99% and it could be achieved within 11 seconds at a temperature of 555.5 °C. Assuming the oxidation reaction was first-order with



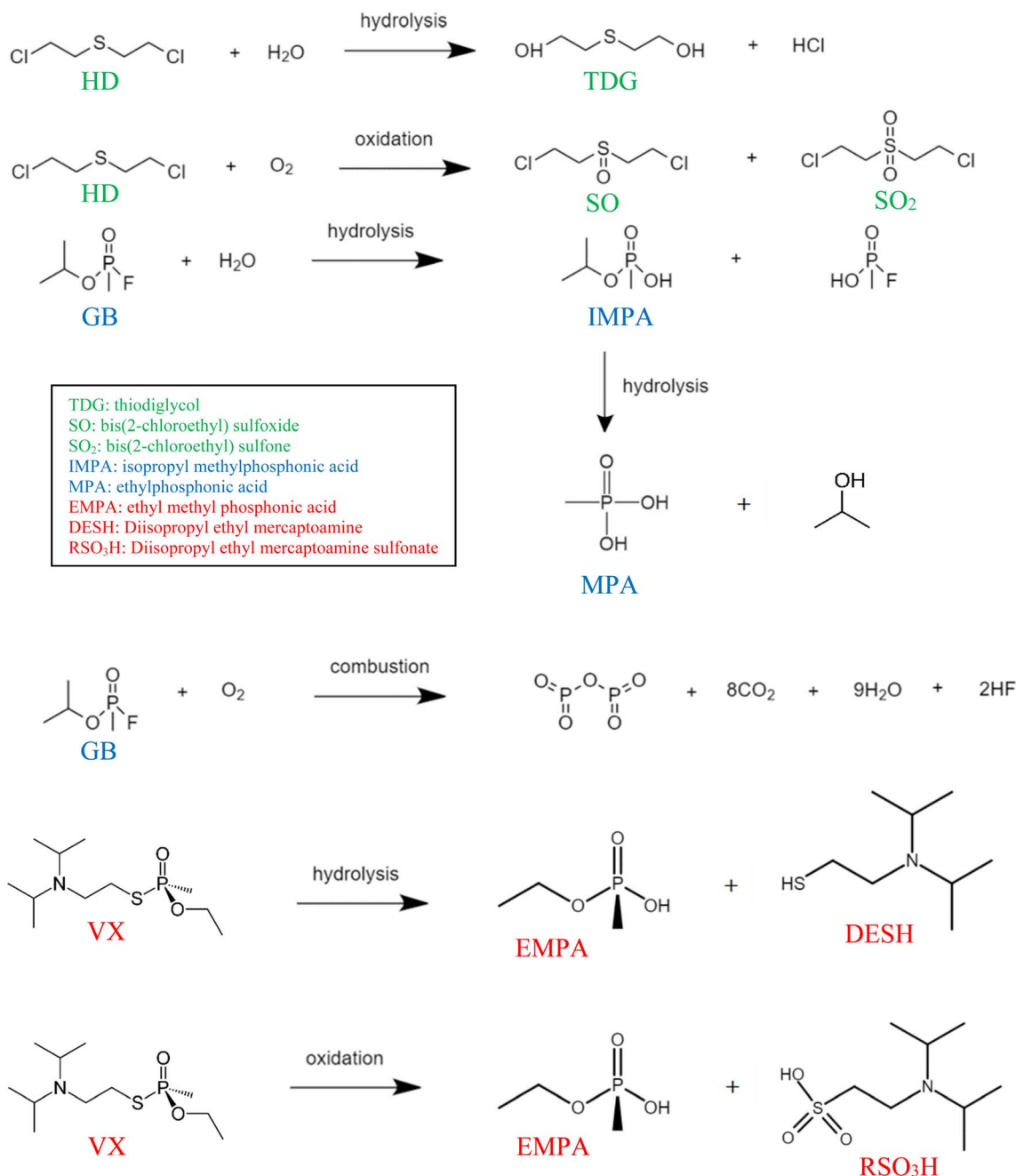

Fig. 6 Sulfur mustard (HD), sarin (GB), and VX reactions.

respect to wastewater and zero-order with respect to the oxidant, the calculated activation energy was $32.35 \pm 2.21 \text{ kJ mol}^{-1}$, and the pre-exponential factor was $54.63 \pm 1.45 \text{ s}^{-1}$ at a 95% confidence level (Lee *et al.*, 2005).¹²

SCWO was used after neutralizing the CWA stockpile at Blue Grass Army Depot. An oxidizing agent (*e.g.*, air or oxygen) was added to the hydrolysates and heated in a SCWO reactor at a pressure of 270 atm and a high temperature (600–650 °C).¹¹ Within less than a minute, the organic compounds react to form sodium carbonate, phosphate, sulfate, and gaseous byproducts (*e.g.*, N₂ and N₂O).¹¹ The system is then cooled, and

the mixture is released from the reactor. The resulting aqueous salt solutions underwent evaporation followed by crystallization. The primary limitation of this technology remains the corrosion of the reactor's heating and cooling elements, which necessitates frequent replacement.

SCWO treatment was tested on glyphosate (an organophosphate herbicide) using both a spiral-coiled tubular reactor and a tank reactor. Various variables were evaluated during the measurement of chemical oxygen demand (COD) removal efficiency. Increasing the temperature, pressure, oxidation coefficient, and residence time improved the treatment process.



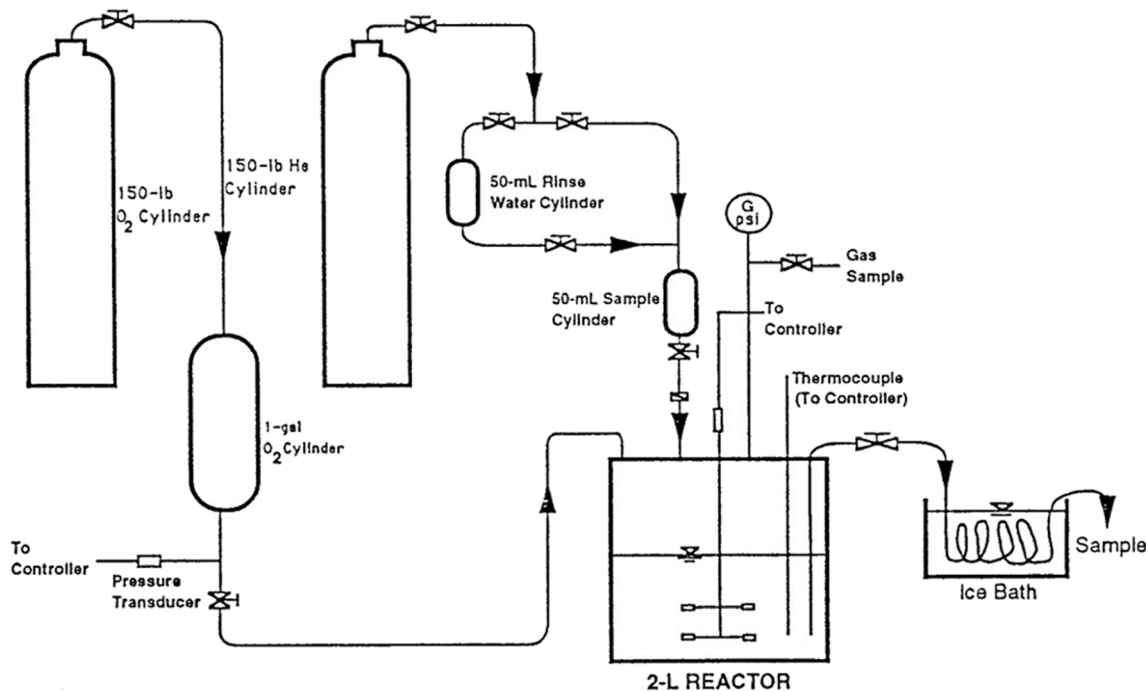

Fig. 7 Wet oxidation experiment with oxygen and helium gas.³⁹

Table 3 Various degradation methods for agents based on their temperature and pressure ranges^a

Method	Temperature range (°C)	Pressure range (bar)	Agent	DRE (%) or TOC (ppm)	Residence time	Comments	References
Wet air oxidation	280	110	Glyphosate	99.8%	60 minutes	Bench scale	Copa and Momont, 1995 (ref. 40)
	280	110	DMMP	>97.5%	60 minutes	Bench scale	Copa and Momont, 1995 (ref. 40)
	320		HD	97.74%	60 minutes	Bench scale	US Army, 2003 (ref. 38)
	320		GB	99.57%	180 minutes	Bench scale	US Army, 2003 (ref. 38)
Supercritical water oxidation	555.5	240	DMMP	99.99%	11 seconds	Laboratory scale	Lee <i>et al.</i> , 2005 (ref. 12)
	635	238	CWA hydrolysate simulant	<5 ppm	10 seconds	Full scale	National Academies of Sciences, 2015 (ref. 41)

^a DRE: destruction and removal efficiency; TOC: total carbon content.

Under the following conditions: 580 °C, 25 MPa, pH of 10, 10 minutes reaction time, and an oxidation coefficient of 2.5, the COD removal efficiencies were 99.48% and 99.86% in the spiral and tank reactors, respectively.³⁷ Table 3 compares the temperature and pressure ranges of different deactivation/degradation techniques for the CWAs HD and GB.

A US Army WAO facility for CWA elimination was estimated to cost \$10 million to construct and \$900k to operate per year. This facility would decontaminate at a rate of 10 gallons per minute, and the estimated cost for the disposing of 32 million pounds of liquid waste was \$1.6 million.³⁸

4.2. Catalyst treatments

Significant research efforts have focused on developing heterogeneous catalysts (*e.g.*, polyoxometalates activated with

transition metals,^{42,43} zeolites,⁴⁴ and mesoporous silica⁴⁵) for the selective oxidation of CWAs into environmentally benign products. These catalysts have demonstrated good selectivity, converting organic sulfides into sulfoxides, which can be helpful for blistering agents such as sulfur mustard.⁴⁶ Table 4 provides an overview of recent studies where catalysts have been applied to oxidize HD simulants under ambient conditions effectively.

Several strategies, including non-metal doping,⁵³ metal deposition (*e.g.*, copper, cobalt, manganese, and silver),^{54,55} and coupled semiconductors,⁵⁶ have been implemented to enhance the photocatalytic activity of titanium oxide (TiO₂) under visible light by increasing the electron-hole pair separation efficiency. Besharati-Seidani, A. (2016),⁵⁷ has discussed degradation of organophosphorus simulants on modified TiO₂





Table 4 Summary of catalytic oxidation approaches for mustard gas (HD) analog with conversion to oxidized products with less toxicity

Catalyst	CWA/simulant type and concentration	Performance and conditions	Ref.
Polyoxometalate $H_2PV_2Mo_{10}O_{40}$ is supported on porous carbons (0.1 g, with each carbon being 10 wt%)	Tetrahydrothiophene (THT; 50.5 mM)	- Oxidizing agent: <i>tert</i> -butylhydroperoxide (TBHP, 91.1 mM) - Temperature: 25 °C - Conversion efficiency: up to 78% - Reusability: can be reactivated by heating at 80 °C - Additive: $Cu(OTf)_2/Cu(NO_3)_2$ solution - Ambient conditions: 1 atm air/ O_2 ; 25 °C - Conversion: 56%	Gall <i>et al.</i> , 1996 (ref. 42) Okun <i>et al.</i> , 2003 (ref. 43)
Cationic silica nanoparticles coated with the anionic multi-iron polyoxometalates (POMs): $K_9[Fe^{III}(OH)_2]_2(PW_9O_{34})_2$ [K_94] or $Na_{12}[(FeOH_2)_2Fe_2(P_2W_{15}O_{50})_2]$ [Na_{125}] Vanadium doped-acid prepared mesoporous silica	2-Chloroethyl ethyl sulfide (CEES; 0.35 M) CEES (0.859 mM)	- Oxidizing agent: <i>tert</i> -butylhydroperoxide (TBHP, 5.5 M in decane) - Temperature: 25 °C - Conversion efficiency: 69 to 97% - Oxidizing agent: hydrogen peroxide (8.5×10^{-2} M) - Temperature: 25 °C - Conversion efficiency: up to 98% - Oxidizing agent: hydrogen peroxide - Temperature: 25 °C - Conversion efficiency: >98% - Oxidizing agent: hydrogen peroxide - Temperature: 25 °C - Conversion efficiency: 80% - Oxidizing agent: 3% hydrogen peroxide - Temperature: 25 °C - Conversion efficiency: 100% - By-products: chloroethyl ethyl sulfoxide and vinyl ethyl sulfoxide - Conversion time: 3 minutes - Oxidizing agent: 3% hydrogen peroxide - Temperature: 25 °C - Conversion efficiency: 94% - Conversion time: 1 hour	Ringenbach <i>et al.</i> , 2005 (ref. 47) Marques <i>et al.</i> , 2001 (ref. 48) Carniato <i>et al.</i> , 2014 (ref. 49) Marchesi <i>et al.</i> , 2021 (ref. 50) Dong <i>et al.</i> , 2017 (ref. 51) Dong <i>et al.</i> , 2018 (ref. 52)
Manganese- and iron- <i>meso</i> -tetraarylporphyrins (2×10^{-3} M)	Dibenzyl sulfide and phenyl-2-chloroethyl sulfide		
Bifunctional Nb^V -containing saponite clay	2-Chloroethyl ethyl sulfide (CEES)		
Co-presence in the saponite structure of luminescent Eu^{III} and catalytic Nb^V metal sites	2-Chloroethyl ethyl sulfide (CEES)		
Polyoxometalate $H_{13}[(CH_3)_4N]_{12}[PNb_{12}O_4O(V^VO)_2(V^VO)_4O_{12}] \cdot 22H_2O$	CEES		
Polyoxoniobate composite $Mg_3Al-LDH-Nb_6$ integrated into textiles	CEES (0.5 mmol)		

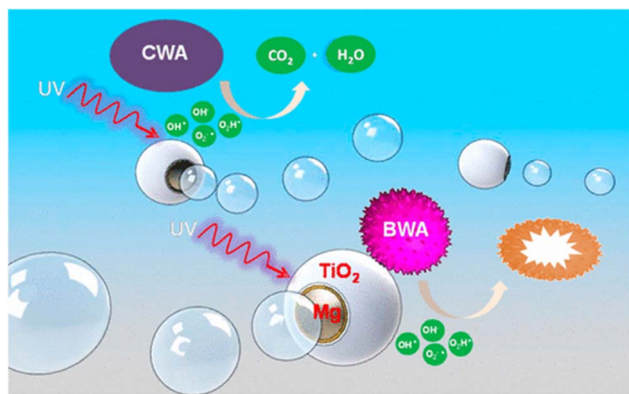

Fig. 8 Schematic illustration of the photocatalytic degradation of CWA and BWA into environmentally benign products via $\text{TiO}_2/\text{Au}/\text{Mg}$ micromotors. (Reprinted with permission from Li *et al.*, 2014).⁵⁸ Copyright 2014 American Chemical Society.

nanophotocatalysts. A schematic illustration of the photocatalytic degradation of CWA and BWA into environmentally friendly products using magnesium-based micromotors modified with titanium dioxide film and gold nanoparticles (*i.e.*, $\text{TiO}_2/\text{Au}/\text{Mg}$ micromotors) is shown in Fig. 8.

OSDEMP (*O,S*-diethyl methylphosphonothioate), a VX simulant, was 97% converted in 60 minutes when mixed with K-NB_6 as a catalyst and hydrogen peroxide. The half-life was about 6 minutes, and only EMPA (ethyl methylphosphonic acid) was detected after the reaction. However, when K-NB_6 , hydrogen peroxide, acetonitrile, and D_2O were mixed with OSDEMP, it was fully converted within 5 minutes, and no EA-2192 (a highly toxic compound) was detected. When K-NB_6 and hydrogen peroxide were tested on CEES, 92% of the compound was converted in 60 minutes, with a half-life of approximately 7 minutes. 95% of the CEES was transformed into CEESO (2-chloroethyl ethyl sulfoxide), and the remaining was CEESO_2 (2-chloroethyl ethyl sulfone).⁵⁹

Guo and co-workers (2021)⁶⁰ have studied the catalytic degradation of CEES with manganese peroxide, MnO_2 . Multiple crystalline morphologies of MnO_2 (α , β , δ , γ) were used to degrade (neutralize) CEES. The γ - MnO_2 had the highest degradation of CEES at 80.4%, and δ - MnO_2 had the lowest at 56.3% after 24 hours. HEES was created when the reaction was performed *via* hydrolysis, and CEES sulfoxide was formed *via* oxidation.

A Ni-salphen-based porous organic polymer contains $\text{Ni-N}_2\text{O}_2$ core sites, which show great promise in oxidizing HD. Thioanisole (TA) was used as the HD simulant, and *tert*-butyl hydroperoxide as the oxidant. After 12 hours, the TA was 95% converted with a 98% sulfoxide selectivity. The oxidation studies were conducted at temperatures ranging from 40 to 100 °C, with 80 °C yielding the highest conversion.^{61,62}

Select organic hypochlorites (MeOCl , EtOCl , iPrOCl , and tBuOCl) were evaluated to neutralize HD simulants. *t*-BuOCl achieved a 94% conversion of CEES and 95% selectivity for CEESO after 1 minute at 0 °C. Other by-products include CEE-SOCl (1%), CEESO_2 (<1%), and diethylsulfinate (<1%).⁶³

Oxone, also known as potassium peroxydisulfate, was used by Delaune *et al.* (2021)⁶⁴ to deactivate CEES *via* oxidative neutralization.⁶⁵ With a flow rate of 1 mL min^{-1} and a residence time of 5.26 minutes, the CEES was fully converted into (much) less toxic CEESO. Longer residence times would lead to the formation of toxic CEESO_2 .⁶⁴ A new custom-built laboratory tubular pyrolyzer was studied to safely destroy CWAs and CWA simulants.²⁰ The reactor was evaluated in the temperature range of 375 and 440 °C with residence times between 4.7 and 51.6 milliseconds. Results were comparable with literature with conversion efficiencies around 95%. Zheng *et al.* (2009)⁶⁶ investigated the pyrolysis of diethyl sulfide (DES), a simulant for mustard gas, using both experimental and computational methods. The study involved a flow reactor and detailed analysis of pyrolysis products, alongside a proposed detailed chemical kinetic model to simulate the experimental results.

The efficacy of metal oxide nanopowders to degrade CEES was also evaluated by Zander *et al.* (2007).⁶⁷ Aluminum oxide was the most effective catalyst of the metal oxides tested (copper oxide, cerium oxide, zinc oxide) due to its high surface area. Surface area heavily influences the effectiveness of a nanoparticle's degradation efficacy, the higher the nanomaterial surface area, the more active reaction sites.

Bai *et al.* (2022)⁶⁸ investigated the use of low-temperature air plasma for cleaning air contaminated with a sulfur mustard surrogate, 2-chloroethylethyl sulfide (CEES). A degradation efficiency of about 99% was reported within 2 min of the plasma treatment. The proposed triboelectric microplasma provides a new approach to developing a portable CWA air cleaning system.

4.3. Metal-organic framework treatments

For CWA detoxification, recent studies have focused on developing and utilizing MOFs – a class of crystalline and porous materials with tunable properties (*e.g.*, size, shape, and topology).⁶⁹ Fig. 9 illustrates of MOF-based composites for the effective detoxification of CWAs.

Zirconium-based MOFs (UiO-66 , UiO-66-NH_2 , UiO-67 , MOF-808 , and NU-1000) were used to degrade DMMP. The FTIR

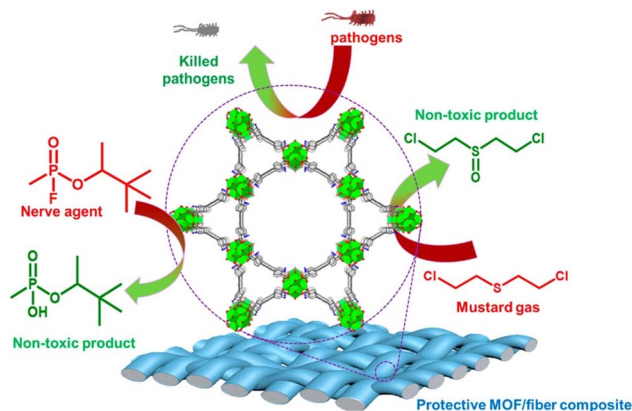

Fig. 9 Schematic illustration of the degradation of CWAs into environmentally friendly products and the deactivation of pathogens. Reprinted with permission.⁷⁰ Copyright 2023 American Chemical Society.



spectra revealed that DMMP physisorbed and formed hydrogen bonds with each of the MOFs. The smaller-pored MOFs (UiO-66 and UiO-66-NH₂) had a low presence of μ_3 -OH groups, while the larger-pored MOFs (UiO-67, MOF-808, and NU-1000) showed a significant loss of the hydroxyl group. Limited desorption of DMMP was observed at room temperature; however, as the temperature increased (up to 600 K), desorption also increased, and the growth of $\nu(\text{O-P-O})$ features was detected. The effect of these MOFs was also tested on 2-CEES. With UiO-66, hydrogen bonds were formed *via* the chlorine atoms, while with UiO-67 and NU-1000, similar bonds formed *via* sulfur and chlorine atoms. Diffusion rates were higher with NU-1000 and slowest with UiO-66.⁷¹

Table 5 provides an overview of some recent studies where MOFs have been used to detoxify (*via* hydrolysis or oxidation) CWA simulants effectively. With their high conversion rates and short half-life times, these catalysts demonstrate significant potential for MOF applications for decontamination.

Other novel approaches are being developed, such as biocatalytic degradation of CWA, which is very promising through either oxidase or phosphodiesterase.⁷² This article lists applications in development for the degradation of organophosphate compounds, which are present in some pesticides and CWAs. Additionally, Econdi *et al.* (2024)⁷³ have described a catalytic approach as a novel, sustainable tool for the degradation of CWAs. Oheix *et al.* (2021)⁷⁴ have studied catalytic processes for the neutralization of sulfur mustard. The review discusses the

neutralization of sulfur mustard and its simulants using different chemical catalytic routes, including hydrolysis, dehydrochlorination, and oxidation, for complete mineralization. This review highlights the limitations and advantages of the approaches reported in the literature, with a focus on catalytic procedures for converting sulfur mustard or its simulants into harmless products. Snider and Hill (2023)⁷⁵ have reviewed functionalized polymers for cleaning CWA contaminated surfaces. Several chemical deactivation and cleaning technologies for CWA removal on several surfaces have been evaluated by Brickhouse,⁷⁶ USEPA,⁷⁷ and Stone *et al.*⁷⁸ New developments in molecular recognition and supramolecular technologies can lead to the detection and scavenging of nerve agents and their surrogates.⁷⁹ There is excellent information⁸⁰ on how metal-organic frameworks can be tailored for the detoxification of organophosphates and other toxic chemicals. Khan *et al.*^{81,82} have conducted computational studies on the solvolysis of CWAs and identified that the hydroxylamine anion is effective in the solvolysis of sarin and nerve agent VX. Such information would help design efficient reactive processes while reducing mass transfer resistance, particularly for viscous agents. Another innovative approach is the use of pyrolyzed cotton balls for the decomposition of CWA simulants, as evaluated by Lagasse *et al.*⁸³ Very few published articles are available in the public domain about the actual amounts of the CWA stockpiles and their destruction. However, a recent review article by Rozsypal *et al.* (2025),⁸⁴ provides information on the

Table 5 Summary of MOF-based approaches for the detoxification of CWA analogs

MOF catalyst	CWA/simulant type	Conditions and performance	Ref.
MOF-808, dosage: 1.5 μmol , half-life (min): <0.5	Dimethyl-4-nitrophenyl phosphate (DMNP) (25 μmol)	- Additive: H ₂ O and <i>N</i> -ethylmorpholine as co-catalyzing agents - Conversion efficiency: 100	Moon <i>et al.</i> , 2015 (ref. 86)
NU-1000-dehydrated; NU-1000, dosage: 25 μmol , half-life (min): 1.5; 1.5	DMNP	- Additive: H ₂ O and <i>N</i> -ethylmorpholine as co-catalyzing agents - Conversion efficiency: 100; 80	Mondloch <i>et al.</i> , 2015 (ref. 87)
UiO-66; UiO-66-(OH) ₂ ; UiO-66-NH ₂ ; UiO-66-NO ₂ , dosage: 25 μmol , half-life (min): 35; 60; 45; 1	DMNP	- Additive: H ₂ O and <i>N</i> -ethylmorpholine as co-catalyzing agents - Conversion efficiency: N/A	Katz <i>et al.</i> , 2015 (ref. 88)
UiO-66; UiO-66-NH ₂ ; UiO-67; UiO-67-NH ₂ , dosage: 1.5 μmol , half-life (min): 25; 0.5; 3.5; 1.9	DMNP (25 μmol)	- Additive: aqueous solution buffered with <i>N</i> -ethylmorpholine as co-catalyzing agents - Conversion efficiency (%): 80; 100; 100; 100	Peterson <i>et al.</i> , 2015 (ref. 89)
UiO-66; UiO-66@LiO <i>t</i> Bu, dosage: 14 μmol , half-life (min): 3; 3	CEES	- Additive: 1 : 1 H ₂ O : EtOH solution - Conversion efficiency (%): 80; 100	López-Maya <i>et al.</i> , 2015 (ref. 90)
PCN-222/MOF-545, dosage: 2 μmol , half-life (min): 13	CEES	- Additive: immersed in methanol, then purged with O ₂ before white LED exposure - Conversion efficiency (%): 100	Liu <i>et al.</i> , 2015 (ref. 91)
NU-1000, dosage: 8 μmol , half-life (min): 6.2	CEES	- Additive: immersed in ethanol then purged with O ₂ - Conversion efficiency (%): 100	Liu <i>et al.</i> , 2016 (ref. 92)
NU-1000 (chromophore-functionalized), dosage: 0.21 mmol, half-life (min): 57 min	DMNP (1.66 mmol)	- Additive: 5,5'-di-thiobis-2-nitrobenzoic acid (DTNB) - Conversion efficiency (%): 100	de Koning <i>et al.</i> , 2019 (ref. 93)



destruction of chemical weapons stockpiles at seven locations in the Russian Federation. The review article includes descriptions of two technologies based on thermal destruction and chemical neutralization of real agents. Thermal destruction⁸⁵ is mainly the incineration process that is used worldwide for the reduction of CWA stockpiles, which can result in 100% DRE. Neutralization technology is a two-stage process that involves adding chemical neutralization agents, followed by the addition of bituminization agents. This neutralization process renders the CWAs into innocuous materials that are safe to dispose of to the environment. This review highlights the potential for regenerating some of the materials used in the process.

5 Summary

This review focused on treatment technologies for the blister agent [mustard gas (HD)], G-series nerve agent sarin (GB), and nerve agent X (VX). The methods evaluated span across different scales, including bench-scale research, pilot-scale demonstrations, and full-scale applications.

Incineration is a well-established technology for the destruction of a wide variety of CWAs. Incineration breaks down chemical compounds through high-temperature combustion effectively neutralizing hazardous substances. Incineration can achieve nearly 100% DREs and can be used for the deactivation of large CWA stockpiles. However, it is a costly operation due to the high temperatures of about 1000–1200 °C and the associated costs of air emissions treatment and control, as well as other safety protocols.

Chemical neutralization of CWA agents is also a viable option for handling CWAs that are released in smaller quantities and for spills. The neutralization processes are also well established, and the neutralization chemicals and the operating temperatures (~20–100 °C) are selected based on the CWA and environmental conditions. The process generates less toxic chemical environments and chemical wastes. It is suitable for handling the waste from cleaning operations, including accidental spills and terrorist attacks.

Wet air oxidation proves to be a promising alternative to CWA incineration treatment. Some of the many benefits include low operating temperature, lower energy consumption, and the reduction or elimination of air emissions and other hazardous chemicals. Some of the major drawbacks include WAO reactor materials and corrosion issues, scale-up costs, and relatively high operating pressures. Often, the operating temperatures range from 200–350 °C, and pressures from 20–200 bars. High pressures are maintained to keep all the CWAs and reaction products in liquid and solid matrices for up to 2–3 hours to achieve 98–99% DRE of the targeted CWA. The treated wastes are deemed safe to dispose of in regular landfills or discharged to waste treatment facilities.

Supercritical wet oxidation, like wet air oxidation, is a high-pressure and temperature process, but with higher temperature (400–650 °C) and 250–350 bars. At these supercritical conditions, the reactant and product transport properties and deactivation kinetics are faster, and 99.99% DRE could be achieved within ~10 seconds to 1 minute. It is a demonstrated

and technically viable process to treat CWA agents; however, due to high temperatures and pressure operating conditions, the costs of corrosion-resistant materials of construction, supercritical processes are not widely adopted for CWA deactivation.

Catalysts contribute to the adsorption, decomposition, or alteration of chemical agents. Metals like zirconium, titanium, and various transition metals are emphasized for their roles in environmental remediation, filtration, and catalysis, particularly for decontaminating areas affected by toxic substances, including chemical warfare agents. Metal catalysts can be utilized in systems designed to neutralize vapors or aerosols on contact, offering a rapid response capability crucial in the aftermath of a terrorist attack using such agents. The operating temperatures, in general, are low, ranging from 20 °C to 100 °C. Selection of a catalyst is crucial for designing a catalytic destruction process. About 70–98% of conversions are possible with the catalytic degradation of CWAs. Catalyst treatment, like the neutralization approach, is suitable for addressing small spills and wide-area cleanup applications.

Metal-organic frameworks (MOFs) are innovative materials that merge metal ions and organic linkers to create highly porous, crystalline structures. The distinctive properties render MOFs effective in a range of applications, notably in neutralizing chemical warfare agents (CWAs). MOFs can trap and decompose CWAs due to their extensive porosity and large surface areas, facilitating efficient adsorption and catalytic breakdown of harmful chemicals. For instance, certain MOFs can hydrolyze nerve agents such as sarin and VX or oxidize mustard gas. Zirconium-based MOFs have robust structural stability and reusability, making them ideal candidates for both hydrolytic and oxidative degradation of CWAs. Their efficiency can be amplified through mechanical methods such as sonication, which accelerates the rate of chemical reactions within the MOFs. Furthermore, the tunability of MOFs through modifications in their metal and organic components enables the creation of materials tailored to specific CWAs and environmental conditions. The application of MOFs to treat contaminated aqueous or gaseous streams can achieve up to 100% deactivation. The technology can be costly and may not be suitable for large-scale applications. It is still in its developmental stage and requires further research.

Despite a wealth of literature information, a need still exists for guidance on preparing for emergency releases in civilian and commercial buildings, as well as indoor spaces. Science-based tools and technologies are required to effectively restore the facilities in case of an accidental and deliberate release of these CWAs. Significant challenges may persist for the successful destruction of CWAs and the assessment of long-term health and environmental risks. To address these issues, innovative remediation and recovery technologies are required for the reclamation of the multimedia environment (soil, water, and air) that are effective, less risky, and easily adaptable. Research efforts should also focus on treating residuals and byproducts that may be toxic and hazardous. In the event of an accidental release or a terrorist activity, emergency responders need safe and cost-effective decontamination methods that are essential



for restoring buildings and large areas. Conventional technologies, such as incineration or chemical neutralization, need simplification for these applications. Surface cleaning using solutions of simple redox agents or modified steam would greatly benefit emergency responders. Long-term environmental, public safety, and health concerns must be carefully considered in these scenarios. Additionally, there is a need for the further development of easily adaptable detection and monitoring methods to assist emergency responders and facility managers.

Conflicts of interest

There are no conflicts to declare.

Data availability

This study was carried out using publicly available data on the following websites; Elsevier, ResearchGate, Springer, PubMed, Google Scholar, United States Environmental Protection Agency (EPA), Academia, United States Department of Energy Office of Scientific and Technical Information (OSTI), American Chemical Society (ACS), Taylor & Francis Online, Science.gov, Royal Society of Chemistry (RSC), United States Centers for Disease Control (CDC), EBSCO, United States Central Intelligence Agency (CIA), United States Department of Energy (DOE), United States National Institute of Standards and Technology (NIST), United Kingdom of Great Britain and Northern Ireland (His Majesty's Government in), Web of Science, Organization for the Prevention of Chemical Weapons (OPCW), United States Occupational Safety and Health administration (OSHA), United States Department of Justice (DOJ), United States National Institute of Occupational Safety and Health (NIOSH), United States Department of Homeland Security (DHS), RAND Corporation, United States Federal Emergency Management Agency (FEMA), United Nations World Health Organization (WHO), United States Air Force (USAF), North Atlantic Treaty Organization (NATO), United States National Academies of Science, Engineering, and Medicine, United States Congressional Research Service (CRS), Defense Research and Development Canada (DRDC), Library and Archives Canada (LAC), United States Department of Defense (DOD), United States Defense Advanced Research Projects Agency (DARPA), Australian Government Department of Defense (AUDOD), United States National Response Team (NRT), U.S. Army Combat Capabilities Development Command (DEVCOM) Chemical Biological Center, Environment and Climate Change Canada (ECCC), United States Army Corps of Engineers (USACE), United States Naval Facilities Engineering Systems Command (NAVFAC), United States Department of Transportation (DOT), Canadian Department of National Defense (DND), United States National Institutes of Health (NIH), McGraw Hill Access Engineering.

Acknowledgements

This work has been reviewed by the U.S. Environmental Protection Agency (EPA) but does not necessarily reflect the

EPA's views. No official endorsement should be inferred. The EPA does not endorse the purchase or sale of any commercial products or services. The authors would like to thank Ramona Sherman and Janet Morris for providing the EPA quality assurance review. We appreciate the EPA's internal peer reviews by Anne Mikelonis and Vasudevan Namboodiri.

References

- 1 J. Chan, R. Yeung and S. Tang, *Hong Kong Journal of Emergency Medicine*, 2002, **9**, 201–205.
- 2 D. Thavaselvam and S. S. Flora, in *Biomarkers in Toxicology*, ed. G. Ramesh, Academic Press, 2014, ch. 30, pp. 521–538.
- 3 B. Friedrich, D. Hoffmann, J. Renn, F. Schmaltz and M. Wolf, *One Hundred Years of Chemical Warfare: Research, Deployment, Consequences*, Springer, Cham, 2017, DOI: [10.1007/978-3-319-51664-6](https://doi.org/10.1007/978-3-319-51664-6).
- 4 J. P. Robinson, T. Stock and R. G. Sutherland, in *World Armaments and Disarmament Stockholm International Peace Research Institute Yearbook*, Oxford University Press, 1993, ch. 14, pp. 705–756.
- 5 C. R. Jabbour, L. A. Parker, E. M. Hutter and B. M. Weckhuysen, *Nat. Rev. Chem.*, 2021, **5**, 370–387.
- 6 P. R. Williams and S. Pearlman, *Case Western Reserve Journal of International Law*, 2019, **51**, 212–221.
- 7 T. Okumura, T. Hisaoka, A. Yamada, T. Naito, H. Isonuma, S. Okumura and K. Suzuki, *Toxicol. Appl. Pharmacol.*, 2005, **207**, 471–476.
- 8 M. Guidotti and F. Trifirò, *Toxicol. Environ. Chem.*, 2016, **98**, 1018–1025.
- 9 J. Matoušek, *Ann. N. Y. Acad. Sci.*, 2006, **1076**, 549–558.
- 10 D. V. Kozlov, A. V. Vorontsov, P. G. Smirniotis and E. N. Savinov, *Appl. Catal., B*, 2003, **42**, 77–87.
- 11 K. Kim, O. G. Tsay, D. A. Atwood and D. G. Churchill, *Chem. Rev.*, 2011, **111**, 5345–5403.
- 12 B. M. Lee, B. Veriansyah, S. H. Kim, J. D. Kim and Y. W. Lee, *Korean J. Chem. Eng.*, 2005, **22**, 579–584.
- 13 R. C. Malhotra, K. Ganesan, K. Sugendran and R. V. Swamy, *Def. Sci. J.*, 1999, **49**, 97–116.
- 14 L. Etemad, M. Moshiri and M. Balali-Mood, *Crit. Rev. Toxicol.*, 2009, **49**, 191–214.
- 15 K. Ganesan, S. K. Raza and R. Vijayaraghavan, *J. Pharm. BioAllied Sci.*, 2010, **2**, 166–178.
- 16 S. L. Bartelt-Hunt, M. A. Barlaz, D. R. Knappe and P. Kjeldsen, *Environ. Sci. Technol.*, 2006, **40**, 4219–4225.
- 17 S. L. Bartelt-Hunt, D. R. Knappe and M. A. Barlaz, *Crit. Rev. Environ. Sci. Technol.*, 2008, **38**, 112–136.
- 18 M. Verma, R. Chandra and V. K. Gupta, *J. Mol. Liq.*, 2016, **215**, 285–292.
- 19 J. Nawala, P. Józwick and S. Popiel, *Int. J. Environ. Sci. Technol.*, 2019, **16**, 3899–3912.
- 20 D. J. Van Buren, T. J. Mueller, C. J. Rosenker, J. A. Barcase and K. A. Van Houten, *J. Anal. Appl. Pyrolysis*, 2021, **154**, 105007.
- 21 J. Bajgar, *Acta Med.*, 2005, **48**, 3–21.
- 22 D. H. Rosenblatt, M. J. Small, T. A. Kimmel and A. W. Anderson, Argonne National Laboratory EAD/TM-56, 1996, DOI: [10.2172/258187](https://doi.org/10.2172/258187).



- 23 N. Sharma and R. Kakkar, *Adv. Mater. Lett.*, 2013, **47**, 508–521.
- 24 US National Response Team, *NRT Chemical Quick Reference Guides*, 2022.
- 25 U.S. Department of the Army, *Chemical Agent Data Sheets*, Edgewood Arsenal Special Report, EO-SR 74001, Defense Technical Information Center, Alexandria, VA, 1974, vol. 1.
- 26 G. S. Pearson and R. S. Magee, *Pure Appl. Chem.*, 2002, **74**, 187–316.
- 27 National Research Council, *Review of Systemization of the Tooele Chemical Agent Disposal Facility*, National Academies Press, 1996.
- 28 L. Dival, The development of an in-field rapid derivatisation technique for the analysis of chemical warfare agent degradants, Masters thesis, Murdoch University, 2018.
- 29 A. F. Kingery and H. E. Allen, *Toxicol. Environ. Chem.*, 1995, **47**, 155–184.
- 30 J. R. Ward, L. L. Szafraniec, W. T. Beaudry and J. W. Hovanec, *J. Mol. Catal.*, 1990, **58**, 373–378.
- 31 National Research Council, *Recommendations for the Disposal of Chemical Agents and Munitions*, The National Academies Press, Washington, DC, 1994.
- 32 CDC, *Public Health Image Library*, 2002.
- 33 CDC, 2024, www.cdc.gov/chemical-weapons-elimination/about/.
- 34 W. G. May, *Scientific Advances in Alternative Demilitarization Technologies*, ed. F. W. Holm, Springer, Dordrecht, NATO ASI Series, Wet Air Oxidation, 1996, vol. 6, pp. 111–128, DOI: [10.1007/978-94-009-1683-8_10](https://doi.org/10.1007/978-94-009-1683-8_10).
- 35 J. R. Portela, E. Nebot and E. M. De La Ossa, *J. Hazard. Mater.*, 2001, **88**, 95–106.
- 36 M. D. Bermejo and M. J. Cocero, *AIChE J.*, 2006, **52**, 3933–3951.
- 37 J. Li, S. Wang, Y. Li, C. Yang, D. Xu, J. Zhang and T. Xu, *Chem. Eng. Res. Des.*, 2021, **168**, 122–134.
- 38 US Army, *Wet Air Oxidation Technology Assessment*, Chemical Materials Agency (Provisional) Program Manager for Elimination of Chemical Weapons, 2003.
- 39 S. W. Maloney, *TNT redwater treatment by wet air oxidation*, US Army Corps of Engineers, Construction Engineering Research Laboratories, 1994.
- 40 W. M. Copa and J. A. Momont, *J. Energy Mater.*, 1995, **13**, 235–258.
- 41 National Academies of Sciences, *Review Criteria for Successful Treatment of Hydrolysate at the Blue Grass Chemical Agent Destruction Pilot Plant*, National Academies Press, 2015.
- 42 R. D. Gall, C. L. Hill and J. E. Walker, *J. Catal.*, 1996, **159**, 473–478.
- 43 N. M. Okun, T. M. Anderson and C. L. Hill, *J. Mol. Catal. A: Chem.*, 2003, **197**, 283–290.
- 44 R. Raja, *Top. Catal.*, 2009, **52**, 322–332.
- 45 O. A. Kholdeeva, *Catal. Sci. Technol.*, 2014, **4**, 1869–1889.
- 46 C. Ramakrishna, R. Krishna, B. Saini, T. Gopi, G. Swetha and S. Chandra Shekar, *Phosphorus, Sulfur Silicon Relat. Elem.*, 2016, **191**, 965–970.
- 47 C. R. Ringenbach, S. R. Livingston, D. Kumar and C. C. Landry, *Chem. Mater.*, 2005, **17**, 5580–5586.
- 48 A. Marques, M. Marin and M. F. Ruasse, *J. Org. Chem.*, 2001, **66**, 7588–7595.
- 49 F. Carniato, C. Bisio, R. Psaro, L. Marchese and M. Guidotti, *Angew. Chem., Int. Ed.*, 2014, **53**, 10095–10098.
- 50 S. Marchesi, M. Guidotti, L. Marchese, C. Evangelisti, F. Carniato and C. Bisio, *Chem.–Eur. J.*, 2021, **27**, 4723–4730.
- 51 J. Dong, J. Hu, Y. Chi, Z. Lin, B. Zou, S. Yang and C. Hu, *Angew. Chem., Int. Ed.*, 2017, **56**, 4473–4477.
- 52 J. Dong, H. Lv, X. Sun, Y. Wang, Y. Ni, B. Zou and C. Hu, *Chem.–Eur. J.*, 2018, **24**, 19208–19215.
- 53 M. Pelaez, P. Falaras, V. Likodimos, K. O'Shea, A. A. de la Cruz, P. S. Dunlop and D. D. Dionysiou, *J. Mol. Catal. A: Chem.*, 2016, **425**, 183–189.
- 54 Y. Liu, X. Wang, F. Yang and X. Yang, *Microporous Mesoporous Mater.*, 2008, **114**, 431–439.
- 55 D. Stoyanova, I. Ivanova, O. Angelov and T. Vladkova, *BioDiscovery*, 2017, **20**, e21596.
- 56 A. Poormohammadi, S. Bashirian, A. R. Rahmani, G. Azarian and F. Mehri, *Environ. Sci. Pollut. Res. Int.*, 2021, **28**, 43007–43020.
- 57 A. Besharati-Seidani, *Iran. J. Catal.*, 2016, **6**, 447–454.
- 58 J. Li, V. V. Singh, S. Sattayasamitsathit, J. Orozco, K. Kaufmann, R. Dong and J. Wang, *ACS Nano*, 2014, **8**, 11118–11125.
- 59 J. Dong, X. Sun, N. Zhen, Z. Li, D. Liu, B. Zou and C. Hu, *J. Catal.*, 2021, **394**, 83–93.
- 60 Y. Guo, L. Kong, M. Lei, Y. Xin, Y. Zuo and W. Chen, *J. Mol. Liq.*, 2021, **333**, 115946.
- 61 P. Kalita, R. Paul, C. W. Pao, R. Chatterjee, A. Bhaumik and J. Mondal, *Chem. Commun.*, 2023, **59**, 5067–5070.
- 62 P. Kalita, R. Paul, A. Boruah, D. Q. Dao, A. Bhaumik and J. Mondal, *Green Chem.*, 2023, **25**, 5789–5812.
- 63 V. E. H. Kassin, D. V. Silva-Brenes, T. Bernard, J. Legros and J. C. M. Monbaliu, *Green Chem.*, 2022, **24**, 3167–3179.
- 64 A. Delaune, S. Mansour, B. Picard, P. Carrasqueira, I. Chataigner, L. Jean and J. Legros, *Green Chem.*, 2021, **23**, 2925–2930.
- 65 S. D. Kim and H. Jung, *Ind. Eng. Chem. Res.*, 2023, **62**, 6672–6686.
- 66 X. Zheng, E. M. Fisher, F. C. Gouldin, L. Zhu and J. W. Bozzelli, *Proc. Combust. Inst.*, 2009, **32**, 469–476.
- 67 N. E. Zander, E. Kowalski, A. M. Rawlett and J. A. Orlicki, *Decontamination of Chemical Agent Simulant by Nanometal Oxides*, TR-4133, Army Research Laboratory, 2007.
- 68 Y. Bai, S. Chen, H. Wang, E. Wang, X. Kong, Y. Gai and Z. Li, *Nano Energy*, 2022, **95**, 106992.
- 69 Y. Liu, A. J. Howarth, N. A. Vermeulen, S. Y. Moon, J. T. Hupp and O. K. Farha, *Coord. Chem. Rev.*, 2017, **346**, 101–111.
- 70 K. Ma, Y. H. Cheung, K. O. Kirlikovali, X. Wang, T. Islamoglu, J. H. Xin and O. K. Farha, *Acc. Mater. Res.*, 2023, **4**, 168–179.
- 71 T. G. Grissom, A. M. Plonka, C. H. Sharp, A. M. Ebrahim, Y. Tian, D. L. Collins-Wildman and J. R. Morris, *ACS Appl. Mater. Interfaces*, 2020, **12**, 14641–14661.
- 72 J. Chen, Z. Guo, Y. Xin, Z. Gu, L. Zhang and X. Guo, *Sci. Total Environ.*, 2023, **867**, 161510.



- 73 S. Econdi, A. Caselli, S. Marchesi, F. Carniato, C. Bisio and M. Guidotti, *Eur. Phys. J. Plus*, 2024, **139**, 782.
- 74 E. Oheix, E. E. Gravel and E. Doris, *Chem.–Eur. J.*, 2021, **27**, 54–68.
- 75 V. G. Snider and C. L. Hill, *J. Hazard. Mater.*, 2023, **442**, 130015.
- 76 M. Brickhouse, T. Lalain, M. Hall, B. Mantooh, V. Henderson, L. Procell, V. Rastogi, K. Sumpter and L. Wallace, *Laboratory Evaluation of the Clean Earth Technologies Decontamination Solutions for Chemical and Biological Agents*, ECBC report ECBC-TR-584, 2008.
- 77 U.S. EPA, *Surface Decontamination Efficacy Studies for Chemical Warfare Blister Agents*, 2017, EPA/600/S-16/275.
- 78 H. Stone, D. See, A. Smiley, A. Ellingson, J. Schimmoeller and L. Oudejans, *J. Hazard. Mater.*, 2016, **314**, 59–66.
- 79 T. J. Finnegan, W. L. Gunawardana and J. D. Badjić, *Chem.–Eur. J.*, 2021, **27**, 13280–13305.
- 80 T. Islamoglu, Z. Chen, M. C. Wasson, C. T. Buru, K. O. Kirlikovali, U. Afrin, M. R. Mian and O. K. Farha, *Chem. Rev.*, 2020, **120**, 8130–8160.
- 81 M. A. S. Khan, M. K. Kesharwani, T. Bandyopadhyay and B. Ganguly, *J. Mol. Struct.: THEOCHEM*, 2010, **944**, 132–136.
- 82 M. A. S. Khan, M. K. Kesharwani, T. Bandyopadhyay and B. Ganguly, *J. Mol. Graphics Modell.*, 2009, **28**, 177–182.
- 83 B. A. Lagasse, L. McCann, T. Kidwell, M. S. Blais and C. D. Garcia, *ACS Omega*, 2020, **5**, 20051–20061.
- 84 T. Rozsypal, *Forensic Chem.*, 2025, **44**, 100658.
- 85 U.S. EPA, *Review of Thermal Destruction Technologies for Chemical and Biological Agents Bound on Materials*, 2015, EPA-600-R-15-202.
- 86 S. Y. Moon, Y. Liu, J. T. Hupp and O. K. Farha, *Angew. Chem.*, 2015, **127**, 6899–6903.
- 87 J. E. Mondloch, M. J. Katz, W. C. Isley III, P. Ghosh, P. Liao, W. Bury and O. K. Farha, *Nat. Mater.*, 2015, **14**, 512–516.
- 88 M. J. Katz, S. Y. Moon, J. E. Mondloch, M. H. Beyzavi, C. J. Stephenson, J. T. Hupp and O. K. Farha, *Chem. Sci.*, 2015, **6**, 2286–2291.
- 89 G. W. Peterson, S. Y. Moon, G. W. Wagner, M. G. Hall, J. B. DeCoste, J. T. Hupp and O. K. Farha, *Inorg. Chem.*, 2015, **54**, 9684–9686.
- 90 E. López-Maya, C. Montoro, L. M. Rodríguez-Albelo, S. D. Aznar Cervantes, A. A. Lozano-Pérez, J. L. Cenís and J. A. Navarro, *Angew. Chem., Int. Ed.*, 2015, **54**, 6790–6794.
- 91 Y. Liu, A. J. Howarth, J. T. Hupp and O. K. Farha, *Angew. Chem.*, 2015, **127**, 9129–9133.
- 92 Y. Liu, C. T. Buru, A. J. Howarth, J. J. Mahle, J. H. Buchanan, J. B. DeCoste and O. K. Farha, *J. Mater. Chem. A*, 2016, **4**, 13809–13813.
- 93 M. C. de Koning, G. W. Peterson, M. van Grol, I. Iordanov and M. McEntee, *Chem. Mater.*, 2019, **31**, 7417–7424.

