

Journal of Materials Chemistry C

Accepted Manuscript



This is an *Accepted Manuscript*, which has been through the Royal Society of Chemistry peer review process and has been accepted for publication.

Accepted Manuscripts are published online shortly after acceptance, before technical editing, formatting and proof reading. Using this free service, authors can make their results available to the community, in citable form, before we publish the edited article. We will replace this *Accepted Manuscript* with the edited and formatted *Advance Article* as soon as it is available.

You can find more information about *Accepted Manuscripts* in the [Information for Authors](#).

Please note that technical editing may introduce minor changes to the text and/or graphics, which may alter content. The journal's standard [Terms & Conditions](#) and the [Ethical guidelines](#) still apply. In no event shall the Royal Society of Chemistry be held responsible for any errors or omissions in this *Accepted Manuscript* or any consequences arising from the use of any information it contains.

From Commercial Tyrosine Polymers to a Tailored Polydopamine Platform: Concepts, Issues and Challenges En Route to Melanin-Based Bioelectronics

Cite this: DOI: 10.1039/x0xx00000x

Marianna Ambrico,^a Paolo F. Ambrico^a, Teresa Ligonzo^b, Antonio Cardone^c, Stefania R. Cicco^c, Marco d'Ischia^d, Gianluca M. Farinola^e

Received 00th January 2012,
Accepted 00th January 2012

DOI: 10.1039/x0xx00000x

www.rsc.org/

Over the past decade synthetic melanins, melanin-like polymers and melanin-based copolymers have been the focus of growing attention as soft biocompatible functional materials for engineering high performance, low cost optoelectronic devices, such as memory devices, light emitting diodes and field effect transistors. The unique combination of physicochemical properties of melanins, such as broad band absorption in the UV-visible range, intrinsic free radical character, water-dependent hybrid ionic-electronic conductor behaviour and excellent biocompatibility, have inspired use of melanic polymers as valuable functional materials for organic bioelectronics. However, several gaps and issues still hinder rapid progress of melanin-based organic electronics and bioelectronics, including in particular the limited contribution of electronic conductivity and current decay with time under biasing. Aim of this paper is to provide an overview of the structural and optoelectronic properties of melanins and to bring to focus current gaps and challenges in the development of melanin-based materials for bioelectronics. Starting from commercial samples, the paper surveys different melanin-type materials with special emphasis on the potential of polydopamine (pDA), a highly adhesive mussel-inspired melanin-type platform, for incorporation in optoelectronic devices. Simple chemical tailoring procedures for engineering pDA-based n-type polymers and photoresponsive materials for photocapacitive sensors are eventually illustrated.

Introduction

Definition and classification of melanins

Originally proposed by Berzelius to denote black animal pigments, the use of the term melanins has evolved over the past decades to encompass a variable range of pigments with consequent generation of ambiguity and often confusion.¹ Recently, terminology issues concerning melanins and melanogenesis have been reviewed and debated.² Eventually, a new general definition of melanins was approved and recommended. According to this new definition, melanins include pigments of diverse structure and origin which arise from the oxidation and polymerization of tyrosine in mammals and of phenolic substrates in plants and lower organisms.

b Dipartimento Interateneo di Fisica, Università a degli Studi di Bari "Aldo Moro", Via Orabona 4, 70125 Bari, Italy

c CNR-Istituto di Chimica dei Composti OrganoMetallici-UOS di Bari, Via Orabona 4, 70125 Bari, Italy

d Università di Napoli "Federico II", Dipartimento di Scienze Chimiche, Via Cintia 4, I-80126 Naples, Italy.

e Dipartimento di Chimica, Università a degli Studi di Bari "Aldo Moro", via Orabona 4, 70125 Bari, Italy

In mammals there are two main types of melanins formed from tyrosine or dopamine. (**Figure 1**) The most diffused variant is the black insoluble eumelanin, which can be identified based on the presence of 5,6-dihydroxyindole (DHI) and 5,6-dihydroxyindole-2-carboxylic acid (DHICA) units at various oxidation levels and linked fairly randomly. Recent evidence indicates that DHI and DHICA polymers exhibit quite different structural characteristics which account for different physicochemical properties, including different optical and electronic behavior.³

In red-haired individuals the main pigments are the reddish-brown pheomelanins which arise from a deviation of the

a CNR-Istituto di Metodologie Inorganiche e dei Plasmi, UOS di Bari, Via Orabona 4, 70125 Bari, Italy. E-mail: marianna.ambrico@cnr.it

eumelanin pathway via the intervention of cysteine leading to 1,4-benzothiazine intermediates. Over the past decade, with the burst of organic electronics, melanins became the focus of increasing interest in materials science, due to the unique combination of intriguing optical and electronic properties in a biological macromolecule. Eumelanins exhibit broad band absorption spectrum, spanning the entire UV-visible range, intrinsic free radical character and, especially, a semiconductor-like behavior strongly dependent on temperature, physical form and hydration state. However, despite their intriguing properties, several gaps and issues still hinder definitive recognition of melanins among state-of-the-art biomaterials for organic electronics. The major problem is represented by the lack of precise knowledge about their structure, supramolecular organization and optoelectronic properties. Another critical issue relates to the lack of standardized protocols for use of melanins in organic electronics, whereby it is not infrequent that data from materials of different origin and composition are compared and used to support inconsequential conclusions.

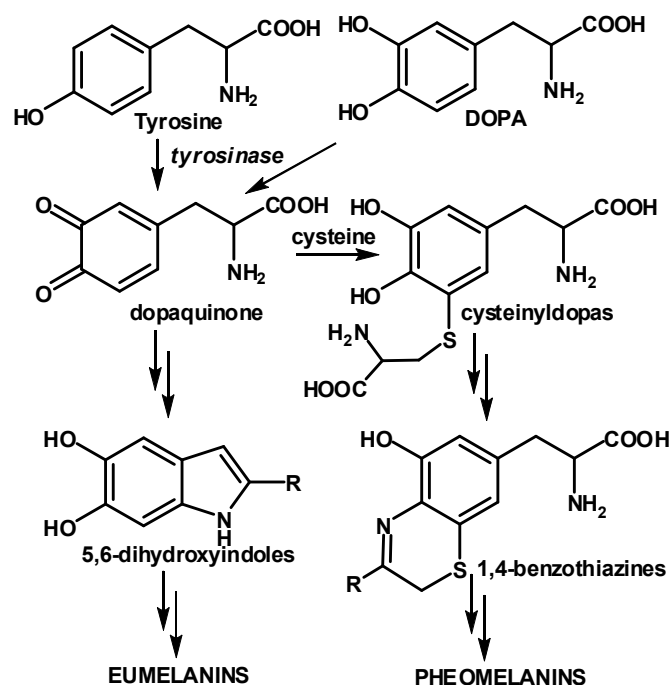

Figure 1. Schematic view of the eumelanin and pheomelanin pathways

In the framework of recent achievements in melanin-based devices the present paper aims to provide a critical overview starting from applications of commercial synthetic melanin in electronic devices, then describing recent achievements with other synthetic melanins (dopa and DHI), and finally illustrating the emerging potential of mussel inspired polydopamine (pDA) as a hitherto little explored melanin-like material for organic electronics. The main motivations, challenges and prospective solutions that drive melanin research in the expanding fields of organic electronics and bioelectronics, together with relevant gaps and issues will be elucidated.

The optical and electrical properties of melanins: models, gaps and issues

Evolution of concepts and models

The pioneering studies on carrier transport mechanisms by McGinness⁴ suggested a preliminary assignment of melanins to the class of amorphous semiconductors. Bistable functioning of a melanin pellet-based device demonstrated the presence of an on-off current switching during voltage application.⁵ It was also observed that such a behavior was maintained only when melanin was in a hydrated state, thus evidencing the dependence of melanin conductivity on the water content. In subsequent work, melanin carrier transport mechanisms were explained in the framework of the amorphous semiconductor model. Jastrzebska et al. established a calibration curve correlating the hydration percentage (by measuring the vacuum level) with the observed conductivity values and activation energies values were estimated.⁶ Recently, Mostert et al. attempted to correlate conductivity, electron paramagnetic resonance (EPR) and muon spin relaxation spectroscopy data to re-formulate the Jastrzebska hydration-dependent conductivity model. They reported that the semiquinone population of a synthetic dopa melanin increases with pH in the same way as both the conductivity and muon relaxation rates vary with hydration. The results underscored the hybrid ionic-electronic behavior of melanins and identified the hydration point at which H⁺-based ionic conductivity dominates on the electronic one (see below).^{7,8}

The subsequent examination of AC conductivities and dielectric polarization further confirmed that charge hopping in a melanin fractal structure is the possible carrier transport mechanism responsible of the observed polarization behavior.⁹ However, the dominant charge carriers (protons or electrons) responsible of the hopping mechanisms are strictly dependant on the hydration melanin state. In this respect, the magnitude of the dielectric permittivity (see next sections) under two extreme hydration conditions (air and under vacuum) further underline the role of water content on conductivity.¹⁰

Several attempts have been made to extrapolate a specific value of the melanin energy gap from optical absorption coefficient measurements, as commonly done in amorphous semiconductors.¹¹⁻¹³ Moreover, the correlation between the activation energy for the carrier transition between the valence and the conduction band (as derived by the conductivity vs. temperature measurements) and optical gap was checked. However, most of the results proved to be contradictory leading to a wide series of uncorrelated values of energy gaps and activation energy.^{12,13}

Work by Bridelli et al.,¹⁴ whose relevance was not appreciated at the onset, demonstrated that hydrogen ion hopping could be instead considered as the main mechanism responsible of electrical carrier transport and that the melanin electret characteristic (i.e. charge/polarization storage ability) is based on its hydration-dependent conductivity. From these results it could be argued that melanin could not be classified as an

amorphous-like semiconductor but rather as an H⁺ conductor, like the majority of biological conducting materials.

Wünsche et al. investigated the interactions of commercial synthetic melanin with Au, Pt and PdHx metallic contacts giving a picture of possible species involved in the H⁺ ion carrier mechanisms¹⁵. The basic conclusion was that melanin current is largely, if not exclusively, ionic in character, being due to proton transport.

Thus, as knowledge of eumelanin optical, electrical and paramagnetic properties progressed, the amorphous semiconductor picture of melanins was gradually abandoned in favor of new models aimed at clarifying the origin of the broadband absorption coefficient and the inability to extract a single energy gap value. Meredith and coworkers¹⁶ proposed the 'chemical disorder model' for modelling the optical absorption spectrum in terms of a linear overlapping of Gaussian shaped absorptions by different chromophores. According to this model, melanin components can be envisaged as separate static entities covering the entire visible spectrum, with no specific reference to the redox state, intermolecular perturbations and hydrogen-bonding effects. An important advance in the characterization of eumelanin intrinsic absorption properties derived from the development of water-soluble eumelanins based on two different approaches, i.e. *i*) functionalization of DHI at the 3-position with an *S*-galactosyl group leading on oxidation to the first glycomelanin, and *ii*) polymerization of DHI or DHCA in aqueous buffer containing 1% poly(vinyl alcohol) (PVA).^{17,18} Detailed studies carried out on soluble eumelanins allowed to disentangle absorption from scattering contributions thus underscoring two important concepts that prompted an integration and expansion of the chemical disorder model. First, it was found that eumelanin soluble chromophores contain both oxidized quinonoid units and reduced catechol unit. Second, eumelanin visible absorption is affected to a variable degree by intermolecular perturbations of chromophores determined by aggregation and stacking. These observations supported an improvement of the chemical disorder model in terms of a "dynamic π -electron disorder model" to explain eumelanin black chromophore. In this model, melanin components would form a dynamic system in which oxidized and reduced units, namely catechol, semiquinone and quinone units, coexist and may equilibrate via intramolecular tautomerization or via intermolecular proton and electron exchange induced by aggregation, dehydration and/or pH changes.¹⁷ This model offers a chemical background also for the hybrid ionic-electronic conductor model. For example, ionic transport can occur at least in part via tautomerization equilibria within oligomer scaffolds coupled with intermolecular proton exchange secondary to comproportionation/aggregation. On the other hand, electronic conductivity may be favored by redox interactions between catechol or quinone components in contact with the electrodes. In support of the dynamic π -electron disorder model is the recent observation of irreversible conductivity changes in DHI melanin suspensions following interaction with a gate electrode in an organic electrochemical

transistor (OECT) device.¹⁹ The OECT device consisted of source and drain electrodes made of silver, an active layer of PEDOT:PSS, and a gate electrode made of a platinum wire. Eumelanin sensing was based on oxidation of suspended eumelanin at the Pt gate electrode/electrolyte interface promoting electron injection into the gate electrical circuit (faradaic regime). Analysis of the resulting hysteretic I_{gs} loops in the presence of melanin revealed a progressive and irreversible decrease in the redox activity of the polymer with an abatement in current intensity with decreased hysteretic loop area after each cycle.

The marked decrease observed in gate current and areas subtended by hysteretic loops observed over 5 cycles suggested evolution of the polymer from an unstable redox state toward a more stable electronic arrangement promoted by redox exchange with the gate electrode. Specifically, the catechol-quinone units would be initially "frozen" by aggregation into an unstable redox state. Repeated redox interactions with the gate electrode would then provide the input for a progressive redistribution of the redox centers within the polymer, leading eventually to equilibration to a more stable electronic arrangement.

Proton Migration, Redox Processes, and Electronic Transport.

As anticipated earlier, the complex interplay between proton migration, redox processes and electronic transport involved in the electrical response of eumelanin films has been the subject of growing interest.^{7,20} It is assumed that before biasing the eumelanin contains DHI and DHICA or similar units in different redox states, i.e. catechol (H₂Q) semiquinone (SQ) and quinones (Q) tautomer as well as protons originating from -COOH, Q and SQ moieties. It has also been proposed that the electronic charge carrier in eumelanin originates from the SQ free radicals,¹⁷ whose density is increased by the water-driven comproportionation equilibrium.²¹ In aqueous suspensions of eumelanin, the SQ⁻ concentration increases up to a factor of 7 between pH 7 and 11. The reduction of Q to SQ⁻ would correspond to the injection of an electron capable to contribute to electronic conduction.¹⁷ At the positive electrode, the extraction of a mobile electron corresponds to the oxidation of SQ⁻ to Q. The transient current behaviors at different hydration states highlighted better on the importance of the proton-determined component of the electrical current and of the elicited electrochemical reactions. Specifically, the initial fast decreasing component is attributable to the proton current blocked at the electrode while the slower one is a result of the superposition of a slower decaying ionic current and of the electrochemical reaction or electronic current.¹⁵ Finally, the proton current component supported a mechanistic scenario in which eumelanin films are proton conductive over micrometric distances and the proton-determined component of the electrical current is strongly sustained by hydration, with an ionic conductivity of 10⁻⁴-10⁻³

Technological issues

Deposition of homogeneous eumelanin layers for optoelectronics application is an issue of considerable technological relevance which depends on the solubility properties. Although it has been reported that eumelanins are soluble in several solvents including concentrated aqueous sodium hydroxide solutions, aqueous ammonium hydroxide solutions, and dimethylsulfoxide (DMSO), attention is called to the fact that solubility depends on the nature of the polymer (i.e. its monomer composition), the degree of polymerization (short or long reaction times for polymer synthesis), and the marked susceptibility of the catechol and quinone moiety to undergo oxidative breakdown or decarboxylation in alkali and acids, respectively.¹ It follows that the process defined as an apparent solubilization may in fact be either a degradation or the dissolution of small fragments with a limited degree of polymerization.

In any case, the choice of the solvent proved to be crucial for smooth film production. In this respect, dimethyl-sulfoxide (DMSO), N,N-dimethylformamide (DMF) or DMSO/DMF based solutions seemed more promising than ammonia aqueous solution in dissolving melanins making possible the deposition of smooth thin films.^{15,22}

However, the surface of films deposited from ammonia based solution were also found smooth, although with a slight incorporation of ammonia ions.¹⁰

Achieving a good degree of filmability of melanin materials on common supports, such as ITO/glass, Si or SiO₂/Si,^{23,10,20} is mandatory for its application in optoelectronics. With respect to other polymers or organic semiconductors, melanins require an almost hydrophilic surface, while the majority of surfaces of the supports for devices possess higher affinity for hydrophobic materials. Therefore, the unavailability of an effective procedure for depositing homogeneous and stable melanin layers on such supports limited, till now, the exploitation of melanins in the simplest electrical devices with metal-insulator-metal (MIM) or metal-insulator-semiconductors configuration (MIS). (**Figure 2**) Recently, our group successfully overcame this issue by adopting a proper strategy to enhance the affinity between melanins and the supports, thus paving the route to the investigation of the performances and possible applications of melanins in bio-inspired devices.^{10,23.}

An interesting protocol to obtain good quality films of DHI melanin starting from aqueous suspensions utilizes matrix assisted pulsed laser evaporation (MAPLE).²⁴ Another important contribution toward this goal is provided by the recently reported ammonia-induced solid state polymerization (AISSP) procedure, in which melanin synthesis is induced in the solid state by exposing a film of the soluble monomer DHI to ammonia vapors.²⁵ Important advantages of the AISSP procedure with respect to previously reported protocols include: 1) efficient chemical control on structural disorder and film morphology, due to the facile deposition of the soluble DHI monomer allowing for more efficient chemical manipulation and tailoring; 2) robustness and strong adhesion of the resulting

film to a variety of substrates, from glass to silicon and plastic polymers; 3) the lack of artifacts associated with post synthetic work-up procedures; 4) synthetic versatility for controlled polymerization and copolymerization with other co-substrates or for engineering wafer architectures; 5) low environmental impact due to the solvent-free, oxygen-based protocol. The AISSP procedure is thus of general relevance, being applicable to any easily oxidizable and filmable polyphenolic substrate.

What melanins for organic- and bio-electronics ?

Intimately connected with the technological issues is the selection of a melanin with suitable characteristics to meet the specific requisites of processability for deposition and device implementation. A vast body of literature deals with commercial synthetic melanin (SM, from Aldrich). SM is a black soluble material which is currently prepared by oxidation of tyrosine with hydrogen peroxide (previously with persulfate). From the structural viewpoint, SM appears to be considerably different from natural melanins or from synthetic dopa, DHI or DHICA melanins, as well as from most catecholamine-derived polymers because it is freely soluble in slightly alkaline aqueous medium and affords, on degradation, very low yields of pyrrole carboxylic acids, suggesting a virtual lack of indole units.² This would be consistent with the lack of dopaquinone formation as a crucial requisite for indole ring closure, thus questioning the claimed analogy of SM with other synthetic melanins, e.g. from dopa, DHI or DHICA. While the relevance of the structural issue may not seem to be compelling from the technological viewpoint, it assumes fundamental importance when attempting to draw structure-property relationships that are crucial for rationally designing melanin-based materials with well-defined conductivity properties and HOMO-LUMO gaps for bioelectronics. A most relevant issue in a realistic melanin device application is the observed current decay under biasing, which is also strictly linked to the hybrid ionic-electronic conducting mechanisms.¹⁵ In principle, such an effect would rule out or limit some applications of eumelanins unless chemical modifications are adopted. However, from a different perspective, this may pave the way to alternative device applications like charge storage, memory devices or proton-conductor polymers which are very important in bio-inspired applications.²⁶

Biocompatibility

Bettinger et al.²⁷ assessed eumelanin biocompatibility in vitro by Schwann cell attachment and growth and by determining neurite extension in PC12 cells. Thin films of SM were found to enhance Schwann cell growth and neurite extension compared to collagen films in vitro. Melanin films also induced an inflammation response that was comparable to silicone implants in vivo and the implants were significantly resorbed after 8 weeks. These results supported solution-processed melanin thin films for use as biodegradable semiconducting biomaterials for tissue engineering.

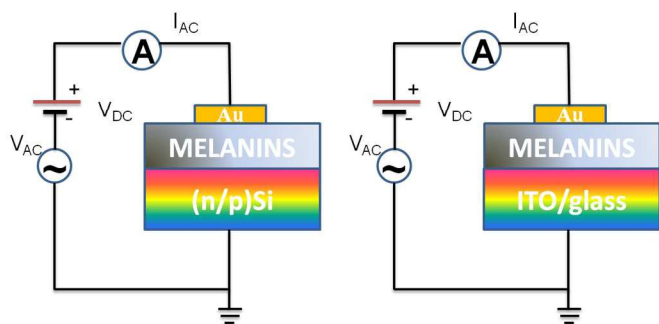

Figure 2. Sketches of melanins –based MIS(left) and MIM (right) devices and of the measurement set up.

In another study of the biocompatibility of DHI melanin thin films produced by the AISSP procedure,²⁵ the growth and differentiation of undifferentiated murine embryonic stem cells was investigated in comparison with gelatin. The results demonstrated the adhesion and proliferation of stem cells on the melanin film. Notably, melanin thin films proved also capable of directing the differentiation of pluripotent stem cells. Using a reporter cell line bearing Green Fluorescent Protein (GFP) under the control of $\alpha 1$ -tubulin promoter, it was possible to demonstrate that the melanin film effectively supports the growth of undifferentiated stem cells and their differentiation into *neuronal precursors and neurons*. These results are of potential interest for the implementation of OECTs which can translate cellular activity into electrical signals.^{19,28,29}

SM electrical properties in devices

Charge storage behavior of SM-based MIM devices

The transient current behaviour occurring after a voltage pulse was a well known effect observed in pellets as such as in melanin layers.³⁰

These led to consider SM as a capacitor able to act as a charge storage device. The estimate of the SM layer dielectric permittivity via impedance measurements returned a value of the dielectric permittivity ranging from $\epsilon_r = 100$ to $\epsilon_r = 10$ at high hydration level while lowering in the de-hydrated state.¹⁰ Moreover, the dielectric permittivity vs. frequency dispersion is closely resembling to that of biological items since it shows a specific feature in the range 10Hz-10kHz termed as β -region whose magnitude depends on hydration conditions.^{31,32} The permittivity values higher than that of water are also observed in some highly conjugated polymers, entailing a redistribution and reordering of the adsorbed water molecules when increasing the humidity level.^{33,34}

The possible application of SM as active layer in charge storage device was assessed by current–voltage hysteresis loop in SM-based MIM devices (Figure 2, right) whose *areas were found* increasing with the loop amplitude or voltage sweep speed.²³ The H^+ ion drift mechanisms and charge exchange reaction via SQ electron release can be considered as responsible of space charge generation.⁷ These effects suggested that SM is able to

store/trap/displace an amount of charges depending on the applied voltage and voltage sweep speed stimulus, in a fashion commonly observed in other polymers tested for charge storage device applications³⁵ therefore providing interesting perspective for similar application of SM –based MIM structures.

The memory-like capabilities of SM layers were also tested in SM MIM devices.²³ An on/off resistance effect ascribed to a writing status, with a current on/off ratio of around 100 was detected.(Figure 3) Following Chua, the hysteresis behavior and resistance transition are both evidencing a possible intriguing application of SM-layer as memristor then constituting a viable alternative to in-organic materials, organic or bio- polymers.^{23,36–39} The absence of any erasing effect underlined a behavior like a write once read many times (WORM) device. The *space charge generation and storage* were observed also when the white light was illuminating the SM-based MIM structures under vacuum. while memory effect was evidenced by the photocurrent behavior resulting after consecutively switching on-off of a continuous white light.²³

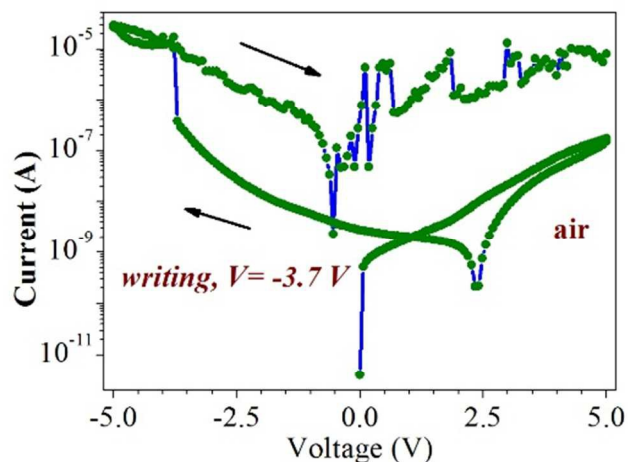

Figure 3. Resistance on/off (memristor-like effect) and WORM-like behaviour observed in a SM MIM device.

Electrical transport in SM-based MIS devices on Si

Polymer-based MIS devices are commonly employed as backbone in charge storage or memory devices. Sometimes the issue that has firstly to be solved is the introduction sites suitable for electron or holes trapping. The commonly adopted procedure is that of embedding properly functionalized metallic clusters into the polymer matrix that are selective irrespective to the particular type of charge to be trapped (i.e. electron or holes).⁴⁰ The read out of the C vs. V hysteretic behaviour is a fundamental test not only on polymer –based MIS devices, since it enables to evidence the type of charges trapped in the device and to estimate the trapping centre density. The basic MIS device parameters, i.e. the flat band capacitance and

voltage constituted the fundamental ones able to give information on the device functioning. The reasoning behind this property descends from the origin of the hysteretic behavior as due to the flat band voltage shift occurring when the MIS device is biased from depletion to accumulation and viceversa.⁴¹ The flat band voltage shift relates both to trapped charges or to mobile ions densities and results in a specific hysteresis loop rotation i.e. a net positive (negative) trapped charge density corresponds to a counter-clockwise (clockwise) hysteresis loop direction. In the case of SM-base MIS device (both on pSi and nSi, see Figure 2, left) the charge trapping effect was achieved without embedding any kind of metallic nano-clusters acting as trapping centre as resulting by the Capacitance-Voltage curves (Figure 4).¹⁰

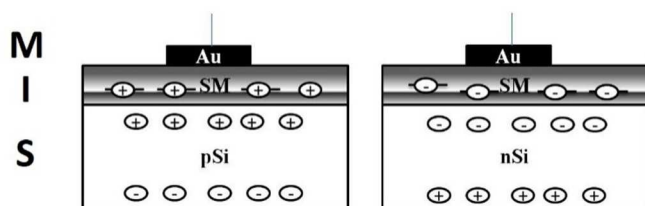

Figure 4. Scheme representing the holes/electrons injection and trapping phenomena responsible of the observed melanins based MIS C-V hysteresis (from ref.20).

Such results disclosed for the first time a viable route for the a melanin-based MIS device working via hybrid electron/hole – ion conductivity mechanisms with the on-off of the two conductivity mechanisms dictated by the hydration level. In fact, in air, the detected loop directions suggested that the majority Si carriers (holes in pSi, electrons in nSi) are injected and trapped inside the SM evidencing the ambipolar characteristics of carrier transport and that water generated trap are responsible of such a behaviour. In vacuum, i.e. at a low hydration state, (Figure 5) the residual inner H⁺ displacement and polarization effect were invoked as responsible of the observed hysteresis.¹⁰

Further studies subsequently directed to possible applications of melanin based MIS structure in memory devices, disclosed a writing step due to carrier injection and trapping (holes) with a signal retention time $t = 10^5$ sec. Interestingly, the applic erasing effect, but rather it produces a polarization induced writing step due to a surface dipole addition.⁴² Considering the *hybrid ionic-electronic model* the surface dipole forms since the negative pulses causes a migration of H⁺ toward the SM/pSi interface while the hole injection is forbidden.²⁰

A further advance toward implementing SM in bio-electronics was to consider its insertion in devices build up on a nanotextured support working via impedance coupling mechanism. The elicited mechanism is commonly adopted in bio-sensing application. Moreover, embedding a nanotextured surface in bio-sensors is useful for enhancing device sensitivity because of the increased useful active sensing area.^{43–45}

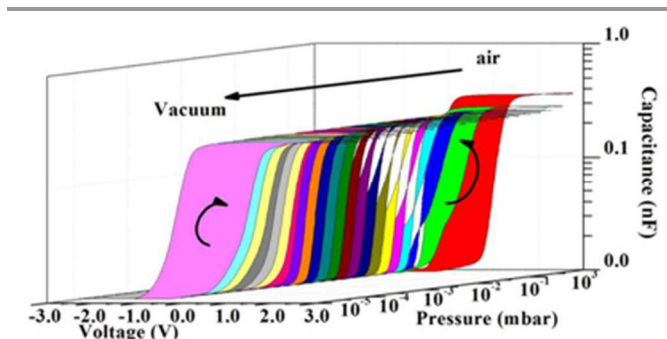

Figure 5. Series of C vs. V hysteresis loops for a melanins-MIS structure on pSi taken real time during vacuum procedure evidencing the pressure of progressive loop direction reversal.

As a proof of concept, SM-layers were implemented on nanotextured and functionalized p-silicon surfaces (NTpSi) produced by single step plasma processing.^{46,47} The device impedance response collected in a wide frequency range showed that melanin adsorption greatly modify the impedance response via impedance coupling mechanism and both texturing topology and chemistry at SM/NTpSi interface were affecting the overall SM/NTpSi bio-interface response (Figure 6).⁴⁸

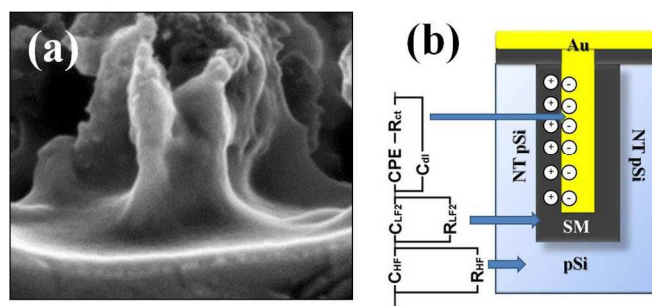

Figure 6 (a) SEM enlarged view nanotextured NT and SM/NTpSi surface. (b) Simplified sketch showing the correspondence between the circuit fragments and the corresponding part of the Au/SM/NTpSi interface (partially reproduced from ref 41)

Synthetic dopa and DHI melanins: electrical properties and their tuning

Several papers reported use of dopa melanin prepared by alkaline oxidation as a useful polymer for organic electronics.⁴⁹ Bothma et al. reported device quality thin films obtained with dopa melanin prepared by ammonia induced polymerization and investigated their conduction properties.⁵⁰ In a four-terminal measurement, DC electrical conductivities were recorded and the conductivity proved to be strongly dependent on the hydration state of the sample. The film showed Ohmic behavior and had a conductivity of $\sigma = 2.5 \times 10^{-5}$ S cm⁻¹ at a relative humidity of 100% and a temperature of 24°C. No trace of metals were detected. In a later paper the same group confirmed a strong hydration dependence of the conductivity

(approximately 2 orders of magnitude dry to wet) that increases rapidly once the water content is greater than approximately 12 % by weight.⁸

Such melanins, however, exhibit a high degree of structural disorder as mentioned earlier, due to the harsh alkaline conditions favoring oxidative breakdown of quinone moieties.²⁵ It is thus very difficult to provide even a tentative and general structural picture of this type of dopa melanins.

Very recently, we disclosed a route for obtaining a water soluble melanin from DHI via N-functionalization of DHI with a hydrophilic TEG chain (**Figure 7**).⁵¹

Current-Voltage measurements in MIM devices indicated markedly higher open circuit values and hysteresis loop areas in

immediate recovery of the conductivity properties, exceeding the starting value. Careful desiccation of the re-hydrated film resulted again in a decrease in conductivity, an effect that could be determined on several cycles of desiccation-hydration, indicating reversibility. Interestingly, the electrical current measured on re-hydrated DHI melanin exceeded the sum of the currents measured on dry eumelanin and in pure water.

Polydopamine as versatile platform for organic electronics

Comparatively little attention has been focused on polydopamine (pDA) as convenient material for organic electronic applications despite the recent burst of interest in this highly adhesive and filmable material. pDA is a polymer obtained by autoxidation of dopamine under slightly alkaline conditions at pH 8.5. It was developed by Messersmith, Lee and coworkers in 2007 taking inspiration from the highly adhesive mussel byssus proteins containing dopa and lysine residues. Accordingly, interest in pDA applications stemmed mainly from its highly adhesive properties.^{52–55,21}

The structure of pDA (**Figure 8**) was addressed by several groups and the basic picture emerging from these studies is that of a mixture of oligomers of different nature and composition which contain three main types of structural units: uncyclized dopamine units, DHI units and degraded pyrrolecarboxylic acid units

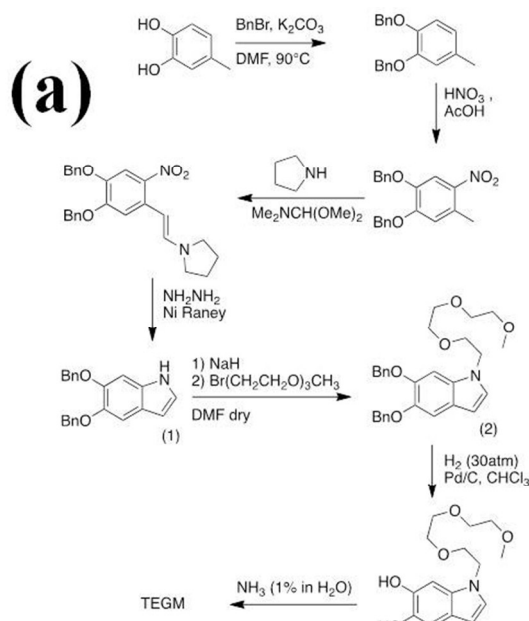

Figure 7 (a) Formation of TEG-melanin by N-functionalization of DHI.

the case of triethyleneglycol-melanin (TEGM) compared to SM, suggesting in the former a more effective space charge mechanism.⁵¹ Impedance data consistently indicated for TEGM a higher dielectric constant than for SM. These results point to DHI functionalization with TEG residues as an effective approach to confer polyelectrolyte behavior to eumelanin materials, possibly via the formation of a tightly retained hydration shell during film deposition, due to the hydrophilic chains of the oligomer molecular component.⁵¹

The electrical properties of the DHI melanin thin films obtained with the AISSP procedure were investigated using a field effect transistor (FET) device with a gold-patterned Si substrate.²⁵ Freshly prepared moisture-equilibrated films showed a significant current I_{DS} in the 45–65 nA range which was not affected by the gate voltage V_{GS} indicating the lack of significant field effect. Current/voltage curves run at $V_{GS} = 0$ V showed a well-defined hysteretic behavior, which did not vary after annealing. After 30 days, a marked drop in conductivity was observed, due apparently to irreversible dehydration. Immersion of the film in deionized water resulted in an

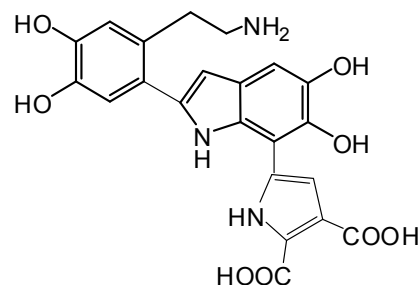

Figure 8 representative structure of pDA highlighting three main types of structural units.

pDA electrical properties

pDA constitutes in principle an attractive platform in organic electronics because of the facile deposition by dip-coating and the eumelanin-like properties consistent with an intrinsic semiconductor behaviour.^{10,56,57} Although, in comparison to SM, pDA showed dielectric permittivity behaviour similar to that of a polyelectrolyte and absence of the β relaxation region, it is suitable as insulating layer in MIS devices since its performances are similar to that of SM-based devices irrespective on the amount of trapped charge density.^{10,57} In this framework, our research was directed at tuning the electronic properties of bio-inspired copolymers obtained by incorporation of amine-containing aromatic monomers into pDA matrix. The organic chemistry strategy relied on the in-air

co-oxidation of dopamine with aromatic amines, specifically 3-aminotyrosine (AT) or *p*-phenylenediamine (PD), leading to copolymers, referred to as pDA-AT and pDA-PD, respectively. (Figure 9) The copolymers formed good quality films and pDA-AT and PD-based MIS devices were afterwards tailored on pSi for the electrical characterization.⁵⁷ In air, pDA-AT and pDA-PD based devices entailing a similar hole trapping phenomenon with a reduction of the net density of trapped positive charges identifying a ‘doping effect’. ‘Doping’ was furthermore evidenced by the flat band voltage shifting to higher values (going from pDA to pDA-AT and pDA-PD) as a result of the Fermi level position displacement towards the

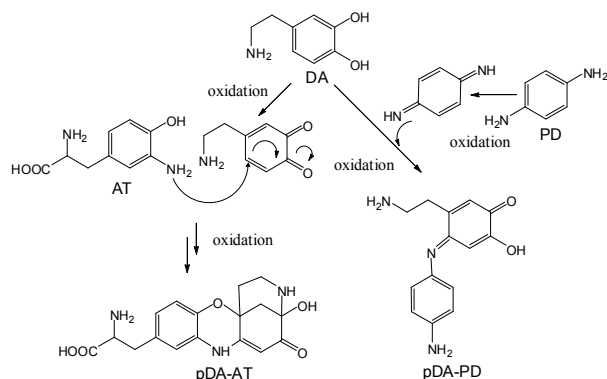

Figure 9. Simplified scheme showing the main proposed units of pDA-AT and pDA-PD

conduction band (n-doping effect). In the specific pDA-PD/pSi case, the increased electron density was furthermore marked (in air and under vacuum) by specific features (bumps) in low frequency C vs. V ascribed to the minority pSi carriers (electrons) and to the in-born PD electron whose density overwhelming the Si dopant concentration. Such carriers are termed as *charge inversion layer* and are readable at a voltage value (i.e. the threshold voltage) whose value depends on the MIS band energy structure (i.e. the higher the MIS barrier, the lower the threshold voltage).⁴¹

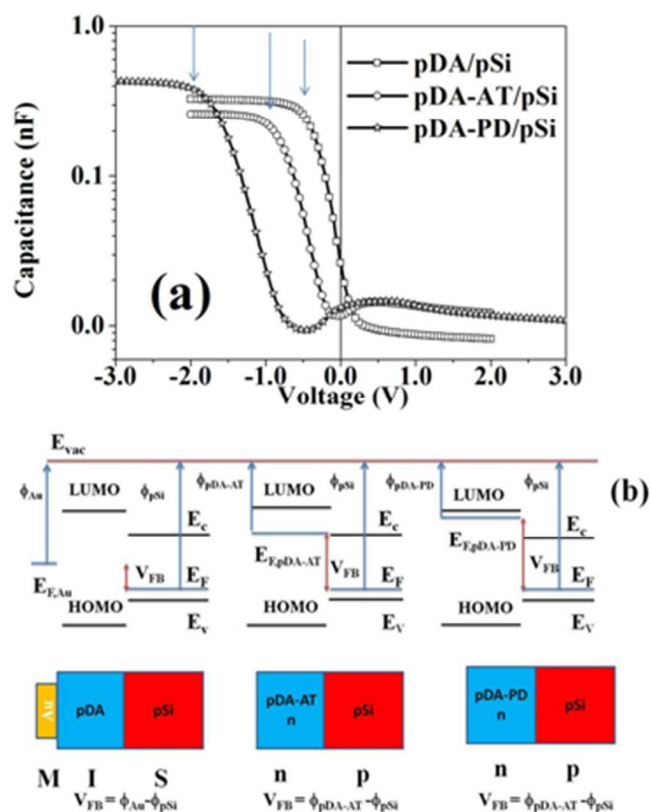

Figure 10 (a) C-V of pDA, pDA-DA, pDA-AT based MIS devices on pSi in air at 1 MHz; the arrows evidence the flat band voltage shifting going from pDA to pDA-PD; **(b)** Energy band diagrams explaining the observed flat band shift as a consequence of the “doping” effect (partially reproduced from Ref 52)

The charge inversion layer can be obviously detected provided that the threshold voltage lies within the measuring range. Although the reasoning of this mechanism, occurring at a low frequency signal only, is still unclear, it is believed that it originates by a slow generation of silicon minority carrier by thermal excitation.⁴¹ In the specific pDA-PD case, as a result of the particular, high value of the flat band voltage, (Figure 10), the threshold voltage V_t lied at around $V = -2.0$ V i.e. the charge inversion layer is detectable during C vs. V measurements.⁴¹

Red-hair inspired manipulation of pDA leading to a photoresponsive material

In the framework of a bio-inspired strategy to improve the light response of pDA, our attention was directed to investigate the incorporation of pheomelanin-type units, such as benzothiazine and benzothiazole moieties, within the pDA scaffold serving as photosensitizing components. Although pheomelanins exhibit intrinsically poor emission properties, they can easily eject electrons upon photoexcitation.⁵⁸ The use of pheomelanin-like materials for technological purposes has been recently considered as an alternative bio-friendly route for the enhancement of the optical response of the Si substrate.⁵⁹ Implementation of this strategy was based on the synthesis of 5-S-cysteinyldopamine, a product of DA metabolism resembling

the pheomelanin precursor 5-S-cysteinyl-dopa.⁵⁹(Figure 11), and its copolymerization in variable proportions with dopamine to give poly(dopamine/5-S-cysteinyl-dopamine) (p(DA/CDA)). Such an approach was innovative in that it combined the features of the photosensitizing pheomelanin-related units into a eumelanin-type skeleton aiming at the enhancement of the light response of the bare polymer.

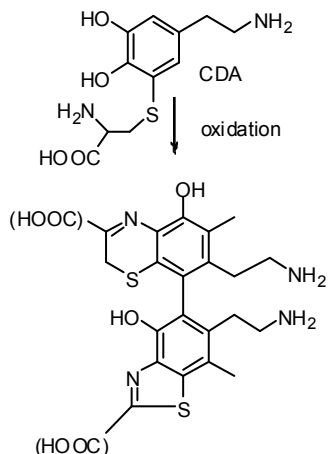

Figure 11. Schematic illustration of pCDA main units

The bio-inspired p(DA/CDA) materials, due to their DA-related basic units, can be considered as a biological-type item. This was confirmed by copolymer AC permittivity signal response similar to that of a biological item and one order of magnitude higher than that detected in commercial SM.

A detectable photocapacitive response was observed only in p(DA/CDA) MIM devices starting at a signal frequency of 10 kHz, with photo-impedance oscillating at a frequency lower than the testing one and particularly pronounced at 1.0 kHz and 100 Hz. (AFM) The results were interesting since for the first time evidenced that the CDA addition promote a peculiar light-induced photo-impedance effect. Implementing pDA, pCDA and p(DA/CDA) in a MIS photo-capacitors device on pSi enables to exploit pCDA and p(DA/CDA) as optically active layers on Si surface. Interestingly, the increase of the CDA content enhanced the sensitivity to white light of the MIS photo-capacitor in the frequency range 100 kHz - 1 MHz illumination, suggesting a fast response of the device to light stimuli. (Figure 12) These results were explained as being due to a combined effect of the pCDA-driven yield enhancement towards the high signal frequency (see Figure 12a), the higher optical absorption cross-section observed in mixed polymer-based structure and of a CDA surface dipole promoting a more efficient carrier transfer from the gold electrode toward the pSi active layer (Figure 12b).

Conclusions and outlook

Why melanin-based bioelectronics ?

The above survey has provided an overview of the current status and perspectives of melanin research in the field of organic electronics and bioelectronics. Is it realistic to develop melanin-based bioelectronics in the near future ? Why melanins instead of other polymers ? A number of arguments are listed below.

1) Melanins are soft, biocompatible, bioavailable and biodegradable. These are Nature-related properties that can hardly be found in common organic polymers for organic electronics

2) Melanins meet all requisites of versatile materials for bioelectronics. They are the sole class of natural polymers exhibiting a broadband featureless optical absorption throughout the entire UV-visible range, nearly quantitative non-radiative conversion of absorbed photon energy, photoconductivity in the solid state, electronic-ionic hybrid conductor properties and hydration-dependent free radical properties. They provide: a) controllable uptake of water up to > 10% w/w; b) a suitable interface endowed with acidic, basic and chelating groups optimally suited to interact with cells; c) ionic and electronic currents coupled with visible light-induced stimulation, accounting for unique bio-optoelectronic properties.

3) Melanins differ from common biocompatible polymers in that they exhibit efficient and tunable antioxidant and free radical scavenger properties, redox activity, aggregation dependent behavior, and exhibit an intrinsically high affinity for biomolecules, such as proteins, lipids and nucleic acids as well as for several organic substances, drugs and metal cations. electronic networks capable of responding dynamically a) to chemical stimuli, via acid and basic carboxylic/carboxylate groups, chelating catechol moieties, redox catechol/semiquinone/o-quinone systems, H-atom donor groups, and b) to physical signals by efficient light absorption, non-radiative excited state deactivation, electron photoejection.

4) Melanins can be built from a variety of monomer precursors, from catecholamines to 5,6-dihydroxyindoles to catechols, to create versatile multifunctional structural and

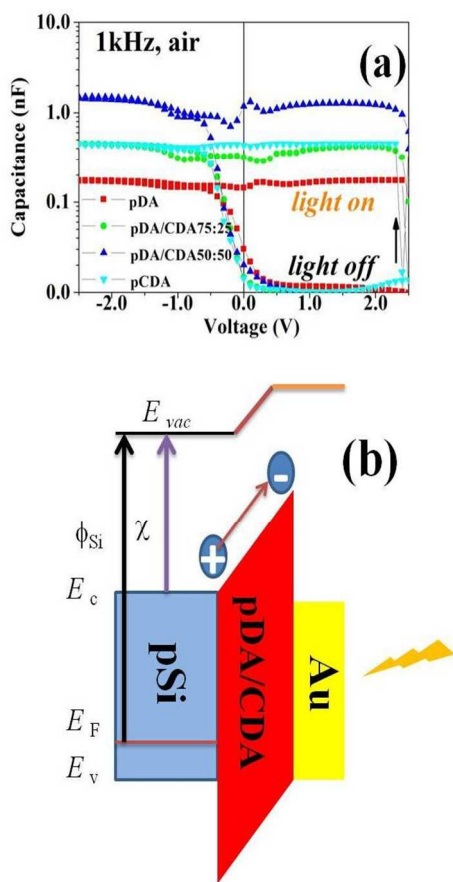

Figure 12. (a) Photo-capacitance effect with compensation at 1 kHz of the pDA, p(DA/CDA) and pCDA-based MIS capacitors. (b) Scheme of the mechanisms explaining the photo-enhanced capacitive response of p(DA/CDA)-based MIS photocapacitors. [from ref. 54]

5) Melanins can form highly adhesive thin films, can self-assemble, can be manipulated through rational strategies targeted at the molecular and supramolecular level, can be functionalized with biomolecules to induce selective biological recognition, impart specific properties and enhance functionality, can be included in biopolymers, can be processed by different methodologies in the absence of toxic organic solvents, and are compatible with sterilization protocols.²⁵

The burst of pDA onto the scene of materials science and nanomedicine is but one example of the enormous technological and biomedical potential of melanin biopolymers which hold promise as biocompatible and biodegradable materials for nerve tissue engineering and other applications.

What challenges?

The above analysis has reported the latest advances in eumelanin applications for organic electronics highlighting major gaps and limitations. A crucial challenge in the development of melanin-based bioelectronics is the improvement of conductivity properties, and especially the control of current decay with time under biasing and a proper

balance of ionic (protonic) and electronic transport. A useful approach may be based on the definition of a clear framework of structure-property-function relationships that may guide the elaboration of new design rules for melanin-based materials.

Another important challenge is to develop effective strategies to control disorder and to engineer melanin based materials with better-defined HOMO LUMO gaps.

What solutions ?

The present paper reported recent achievements by the authors as possible solutions for a viable inclusion of multifunctional melanin related matrixes into bio-friendly devices. Optoelectronic peculiar performances of basic building blocks of solid state and organic electronic devices (MIM, MIS) embedding melanins and eumelanin-like layers have been described. The charge storage and memory effect behaviours, doping and photocapacitive effects in basic and modified melanin-like materials have been presented via device characterization techniques. The study of optoelectronic response in melanin-based MIM and MIS devices under two extreme environmental conditions [i.e. in ambient air and under vacuum at $p=10^{-5}$ mbar] enlighten the hybrid ion-electronic carrier transport mechanisms and possible expected performances and exploitation of melanin-based devices. The feasibility of melanin layer following the contour of a nanotextured surfaces paves the route for a high sensitive nanotextured biosensing device. *N*-functionalization with TEG hydrophilic chains and copolymerization with aromatic amines is proposed as a valuable strategy to enhance the electronic component of charge transport in melanins. Likewise, incorporation of cysteinyl-dopamine and related benzothiazine units allows for the induction of a photoresponsive behavior in pDA. The potential of pDA as a tuneable platform is still undervalued, and a systematic investigation of tailoring strategies like those illustrated in this overview will eventually open novel perspectives in the development of efficient biointerfaces for bioelectronic applications.

Acknowledgements

MdI, M.A. and P.F.A acknowledge PRIN 2010-2011 (2010PFLRJR) project (PROxi project).

M.A., P.F.A, T.L and G.M.F acknowledge the Potenziamento Strutturale PONA3_00369 "Laboratorio per lo Sviluppo Integrato delle Scienze e delle Tecnologie dei Materiali Avanzati e per dispositivi innovativi (SISTEMA)" dell'Università degli Studi di Bari "A. Moro"

M.A., P.F.A. greatly acknowledge Mr. Giuseppe Casamassima for technical support.

Notes and references

a CNR-Istituto di Metodologie Inorganiche e dei Plasmi, UOS di Bari, Via Orabona 4, 70125 Bari, Italy. E-mail: marianna.ambrico@cnr.it
b Dipartimento Interateneo di Fisica, Università a degli Studi di Bari "Aldo Moro", Via Orabona 4, 70125 Bari, Italy

- c CNR-Istituto di Chimica dei Composti OrganoMetallici-UOS di Bari, Via Orabona 4, 70125 Bari, Italy
 d Università di Napoli “Federico II”, Dipartimento di Scienze Chimiche, Via Cintia 4, I-80126 Naples, Italy.
 e Dipartimento di Chimica, Università degli Studi di Bari “Aldo Moro”, via Orabona 4, 70125 Bari, Italy
- G. Prota, *Melanins and Melanogenesis*, Academic Press, Inc., San Diego, California, USA, 1st edn., 1992.
 - M. d’Ischia, K. Wakamatsu, A. Napolitano, S. Briganti, J.-C. Garcia-Borron, D. Kovacs, P. Meredith, A. Pezzella, M. Picardo, T. Sarna, J. D. Simon, and S. Ito, *Pigment Cell Melanoma Res.*, 2013, **26**, 616–33.
 - L. Panzella, G. Gentile, G. D’Errico, N. F. Della Vecchia, M. E. Errico, A. Napolitano, C. Carfagna, and M. D’Ischia, *Angew. Chemie*, 2013, **125**, 12916–12919.
 - J. E. McGinness, *Science (80-)*, 1972, **177**, 896–897.
 - J. McGinness, P. Corry, and P. Proctor, *Science*, 1974, **183**, 853–855.
 - M. M. Jastrzebska, H. Isotalo, J. Paloheimo, H. Stubb, and B. Pilawa, *J. Biomater. Sci. Polym. Ed.*, 1996, **7**, 781–793.
 - A. B. Mostert, B. J. Powell, F. L. Pratt, G. R. Hanson, T. Sarna, I. R. Gentle, and P. Meredith, *Proc. Natl. Acad. Sci. U. S. A.*, 2012, 1–5.
 - A. B. Mostert, B. J. Powell, I. R. Gentle, and P. Meredith, *Appl. Phys. Lett.*, 2012, **100**, 093701.
 - M. M. Jastrzebska and S. Jussila, *J. Mater. Sci.*, 1998, **33**, 4023–4028.
 - M. Ambrico, P. F. Ambrico, A. Cardone, T. Ligonzo, S. R. Cicco, R. Di Mundo, V. Augelli, G. M. Farinola, and R. Di Mundo, *Adv. Mater.*, 2011, **23**, 3332–6.
 - V. P. Grishchuk, S. A. Davidenko, I. D. Zholner, A. B. Verbitskii, M. V. Kurik, and Y. P. Piryatinskii, *Tech. Phys. Lett.*, 2002, **28**, 896–898.
 - T. Ligonzo, M. Ambrico, V. Augelli, G. Perna, L. Schiavulli, M. A. Tamma, P. F. Biagi, A. Minafra, and V. Capozzi, *J. Non. Cryst. Solids*, 2009, **355**, 1221–1226.
 - V. Capozzi, G. Perna, P. Carmone, A. Gallone, M. Lastella, E. Mezzenga, G. Quartucci, M. Ambrico, V. Augelli, P. F. Biagi, T. Ligonzo, A. Minafra, L. Schiavulli, M. Pallara, and R. Cicero, *Thin Solid Films*, 2006, **511-512**, 362–366.
 - M. Bridelli, R. Capelletti, and P. R. Crippa, *J. Electroanal. Chem., Bioelectrochemistry Bioenerg.*, 1981, **128**, 555–567.
 - J. Wunsche, F. Ciccoira, C. F. O. Graeff, and C. Santato, *Journal Mater. Chem. B*, 2013, **1**, 3836–3842.
 - P. Meredith, B. J. Powell, J. Riesz, S. Nighswander-Rempel, M. R. Pederson, and E. Moore, *Soft Matter*, 2006, **2**, 37–44.
 - A. Pezzella, A. Iadonisi, S. Valerio, L. Panzella, A. Napolitano, M. Adinolfi, and M. d’Ischia, *J. Am. Chem. Soc.*, 2009, **131**, 15270–5.
 - A. Pezzella, V. Ambrogio, M. Arzillo, A. Napolitano, C. Carfagna, and M. d’Ischia, *Photochem. Photobiol.*, 2010, **86**, 533–7.
 - G. Tarabella, A. Pezzella, A. Romeo, P. D’Angelo, N. Coppedè, M. Calicchio, M. d’Ischia, R. Mosca, and S. Iannotta, *J. Mater. Chem. B*, 2013, **1**, 3843.
 - J. Wünsche, Y. Deng, P. Kumar, E. Di Mauro, E. Josberger, J. Sayago, A. Pezzella, F. Soavi, F. Ciccoira, M. Rolandi, and C. Santato, *Chem. Mater.*, 2015, **27**, 436–442.
 - Y. Liu, K. Ai, and L. Lu, *Chem. Rev.*, 2014, **114**, 5057–5115.
 - E. S. Bronze-Uhle, A. Batagin-Neto, P. H. P. Xavier, N. I. Fernandes, E. R. de Azevedo, and C. F. O. Graeff, *J. Mol. Struct.*, 2013, **1047**, 102–108.
 - M. Ambrico, A. Cardone, T. Ligonzo, V. Augelli, P. F. Ambrico, S. Cicco, G. M. Farinola, M. Filannino, G. Perna, and V. Capozzi, *Org. Electron.*, 2010, **11**, 1809–1814.
 - F. Bloisi, A. Pezzella, M. Barra, F. Chiarella, A. Cassinese, and L. Vicari, *J. Appl. Phys.*, 2011, **110**, 2–5.
 - A. Pezzella, M. Barra, A. Musto, A. Navarra, M. Alfè, P. Manini, S. Parisi, A. Cassinese, V. Criscuolo, and M. d’Ischia, *Mater. Horiz.*, 2015.
 - L. Q. Zhu, C. J. Wan, L. Q. Guo, Y. Shi, and Q. Wan, *Nat. Commun.*, 2014, **5**, 3158.
 - C. J. Bettinger, J. P. Bruggeman, A. Misra, J. T. Borenstein, and R. Langer, *Biomaterials*, 2009, **30**, 3050–7.
 - J. Rivnay, R. M. Owens, and G. G. Malliaras, *Chem. Mater.*, 2014, **26**, 679–685.
 - R. M. Owens and G. G. Malliaras, *MRS Bull.*, 2010, **35**, 449–456.
 - J. Wünsche, L. Cardenas, F. Rosei, F. Ciccoira, R. Gauvin, C. F. O. Graeff, S. Poulin, A. Pezzella, and C. Santato, *Adv. Funct. Mater.*, 2013, n/a–n/a.
 - H. P. Schwan, in *Advances in Biological and Medical Physics*, vol. 5, eds. J. H. Lawrence and C. A. Tobias, Academic Press Inc., New York, 1957, pp. 147–209.
 - G. Schwarz, *J. Phys. Chem.*, 1962, **66**, 2636–2642.
 - W. M. Groenewoud, in *Characterisation of Polymers by Thermal Analysis*, Elsevier, 2001, pp. 123–187.
 - H. a. Pohl, *J. Electron. Mater.*, 1986, **15**, 201–203.
 - H. S. Majumdar, A. Bandyopadhyay, A. Bolognesi, and A. J. Pal, *J. Appl. Phys.*, 2002, **91**, 2433–2437.
 - L. Li, Q.-D. Ling, S.-L. Lim, Y.-P. Tan, C. Zhu, D. S. H. Chan, E.-T. Kang, and K.-G. Neoh, *Org. Electron.*, 2007, **8**, 401–406.
 - L. Chua, *IEEE Trans. Circuit Theory*, 1971, **CT-18**, 507–519.

38. L. Chua, *Appl. Phys. A Mater. Sci. Process.*, 2011, **102**, 765–783.
39. G. K. Johnsen, *J. Electr. Bioimpedance*, 2012, **3**, 20–28.
40. W. L. Leong, P. S. Lee, A. Lohani, Y. M. Lam, T. Chen, S. Zhang, A. Dodabalapur, and S. G. Mhaisalkar, *Adv. Mater.*, 2008, **20**, 2325–2331.
41. E. H. Nicollian and J. R. Brews, *MOS (Metal Oxide Semiconductor) Physics and Technology*, New York, 1981.
42. M. Ambrico, P. F. Ambrico, T. Ligonzo, A. Cardone, S. R. Cicco, A. Lavizzera, V. Augelli, and G. M. Farinola, *Appl. Phys. Lett.*, 2012, **100**, 253702.
43. P. R. Solanki, A. Kaushik, V. V. Agrawal, and B. D. Malhotra, *NPG Asia Mater.*, 2011, **3**, 17–24.
44. L. S. Wong, C. V. Karthikeyan, D. J. Eichelsdoerfer, J. Micklefield, and C. a. Mirkin, *Nanoscale*, 2012, **4**, 659.
45. C. Rogero, B. T. Chaffey, E. Mateo-Martí, J. M. Sobrado, B. R. Horrocks, A. Houlton, J. H. Lakey, C. Briones, and J. A. Martín-Gago, *J. Phys. Chem. C*, 2008, **112**, 9308–9314.
46. R. Di Mundo, M. Ambrico, P. F. Ambrico, R. D'Agostino, F. Italiano, and F. Palumbo, *Plasma Process. Polym.*, 2011, **8**, 239–245.
47. M. Ambrico, R. Di Mundo, P. F. Ambrico, R. D'Agostino, T. Ligonzo, and F. Palumbo, *J. Appl. Phys.*, 2012, **111**, 094903.
48. M. Ambrico, P. F. Ambrico, A. Cardone, S. R. Cicco, F. Palumbo, T. Ligonzo, R. Di Mundo, V. Petta, V. Augelli, P. Favia, and G. M. Farinola, *J. Mater. Chem. C*, 2014, **2**, 573–582.
49. P. Meredith, C. J. Bettinger, M. Irimia-Vladu, a B. Mostert, and P. E. Schwenn, *Rep. Prog. Phys.*, 2013, **76**, 034501.
50. J. P. Bothma, J. de Boor, U. Divakar, P. E. Schwenn, and P. Meredith, *Adv. Mater.*, 2008, **20**, 3539–3542.
51. S. R. Cicco, M. Ambrico, P. F. Ambrico, M. M. Talamo, A. Cardone, T. Ligonzo, R. Di Mundo, C. Giannini, T. Sibillano, G. M. Farinola, P. Manini, A. Napolitano, V. Criscuolo, and M. D'Ischia, *J. Mater. Chem. C*, 2015, **00**, 1–7.
52. H. Lee, S. M. Dellatore, W. M. Miller, and P. B. Messersmith, *Science*, 2007, **318**, 426–30.
53. J. H. Waite, *Nat. Mater.*, 2008, **7**, 8–9.
54. D. R. Dreyer, D. J. Miller, B. D. Freeman, D. R. Paul, and C. W. Bielawski, *Chem. Sci.*, 2013, **4**, 3796.
55. V. Ball, D. Frari, M. Michel, M. J. Buehler, V. Toniazzo, M. K. Singh, J. Gracio, and D. Ruch, *Bionanoscience*, 2011, **2**, 16–34.
56. H. J. Nam, J. Cha, S. H. Lee, W. J. Yoo, and D.-Y. Jung, *Chem. Commun.*, 2014, **50**, 1458–61.
57. M. Ambrico, P. F. Ambrico, A. Cardone, N. F. Della Vecchia, T. Ligonzo, S. R. Cicco, M. M. Talamo, A. Napolitano, V. Augelli, G. M. Farinola, and M. d'Ischia, *J. Mater. Chem. C*, 2013, **1**, 1018.
58. T. Ye, L. Hong, J. Garguilo, A. Pawlak, G. S. Edwards, R. J. Nemanich, T. Sarna, and J. D. Simon, *Photochem. Photobiol.*, 2006, **82**, 733–7.
59. M. Ambrico, N. F. Della Vecchia, P. F. Ambrico, A. Cardone, S. R. Cicco, T. Ligonzo, R. Avolio, A. Napolitano, and M. D'Ischia, *Adv. Funct. Mater.*, 2014, **24**, 7161–7172.

From Commercial Tyrosine Polymers to a Tailored Polydopamine Platform: Concepts, Issues and Challenges En Route to Melanin-Based Bioelectronics

Marianna Ambrico, Paolo F. Ambrico, Teresa Ligonzo, Antonio Cardone, Stefania R. Cicco, Marco d'Ischia, Gianluca M. Farinola

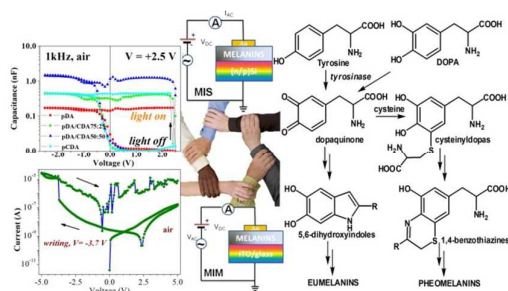

Current issues/challenges are presented in the biocompatible eumelanin-based devices development ranging from commercial eumelanins through 5,6-dihydroxyindole polymers to mussel-inspired polydopamine