

 Cite this: *RSC Adv.*, 2024, 14, 15167

Received 22nd March 2024

Accepted 2nd May 2024

DOI: 10.1039/d4ra02206h

rsc.li/rsc-advances

Catalytic asymmetric carbenoid α -C–H insertion of ether

 Xin Li,^a San-Hong Yue,^b Zi-Yang Tan,^a Shu-Bo Liu,^b De-Xiang Luo,^a Ying-Jun Zhou^{*a} and Xiao-Wei Liang^{†b}

Significant advancements have been made in catalytic asymmetric α -C–H bond functionalization of ethers *via* carbenoid insertion over the past decade. Effective asymmetric catalytic systems, featuring a range of chiral metal catalysts, have been established for the enantioselective synthesis of diverse ether substrates. This has led to the generation of various enantioenriched, highly functionalized oxygen-containing structural motifs, facilitating their application in the asymmetric synthesis of bioactive natural products.

1. Introduction

C–H functionalization continues to be one of the forefronts of organic chemistry.¹ The resurgence of carbenoid transformations from diazo compounds has garnered significant attention due to their effectiveness in transition-metal and enzyme-catalyzed C–H functionalization.² While the spontaneous decomposition of ethyl diazoacetate was first studied in 1906 by Silberrad and Roy,³ it was not until Yates suggested the participation of transition metals in diazo decompositions that the true potential of diazo chemistry began to emerge.⁴ Particularly noteworthy is the ability of *in situ* formed highly active metal carbenoids to insert into C–H bonds of aromatics and alkanes.⁵ Especially with direct C–H bond functionalization with different transition metals, such as Cu,⁶ Ir,⁷ Rh⁸ and others,⁹ the *in situ* formed highly active metal carbenoids are ideal to insert into C–H bonds of aromatics and alkanes. Despite extensive research on alkyl amines and alcohols, catalytic asymmetric α -C–H functionalization of ethers remains challenging. Early studies by Adams, Frenette, and coworkers in 1989 demonstrated that the C–H bond adjacent to an ether is a preferred site for insertion catalyzed by rhodium acetate.¹⁰ Subsequent breakthroughs by Doyle and Davies and their coworkers showcased the remarkable efficiency and enantioselectivity achievable using chiral rhodium carboxamides (Rh₂(5*S*-MEPY)₄) and newly designed dirhodium complexes, respectively.¹¹ Since then, the chiral dirhodium complex has dominated the asymmetric C–H insertion of diazo compounds.¹² Fig. 1 showcases highly active ether natural products and drug candidates, emphasizing the significance of

ether compound synthesis methodology in drug discovery and natural product synthesis (Fig. 1). Ether compounds possess higher α -C–H bond dissociation energy and limited metal coordination capability compared to compounds such as amines, sulfur, and olefins. This characteristic presents a challenge for the functionalization of α -C–H bonds in ethers (Fig. 2). Herein, we present a comprehensive review of recent advancements in α -C–H bond carbenoid insertion of ethers, underscoring the importance of this methodology in the total synthesis of ether natural products.¹³

2. Intramolecular α -C–H bond carbenoid insertion of ether

2.1 Synthesis of dihydrobenzofurans

In 1996, Davies and his colleagues reported the development of a newly designed chiral catalyst, Rh₂(*S*-DOSP)₄, commonly known as Davies's catalyst, and successfully applied it to intermolecular enantioselective C–H insertion reactions.^{11b} Subsequently, they achieved the intramolecular asymmetric synthesis of

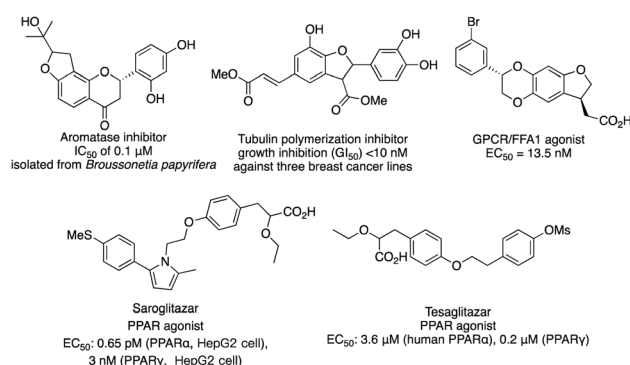

Fig. 1 Representative bioactive nature products.

^aXiangya School of Pharmaceutical Sciences, Central South University, Changsha, 410013, China. E-mail: zhouyingjun@csu.edu.cn

^bHunan Key Laboratory of Skin Cancer and Psoriasis, Xiangya Hospital, Central South University, Changsha, 410013, China. E-mail: xiaowei.liang@csu.edu.cn

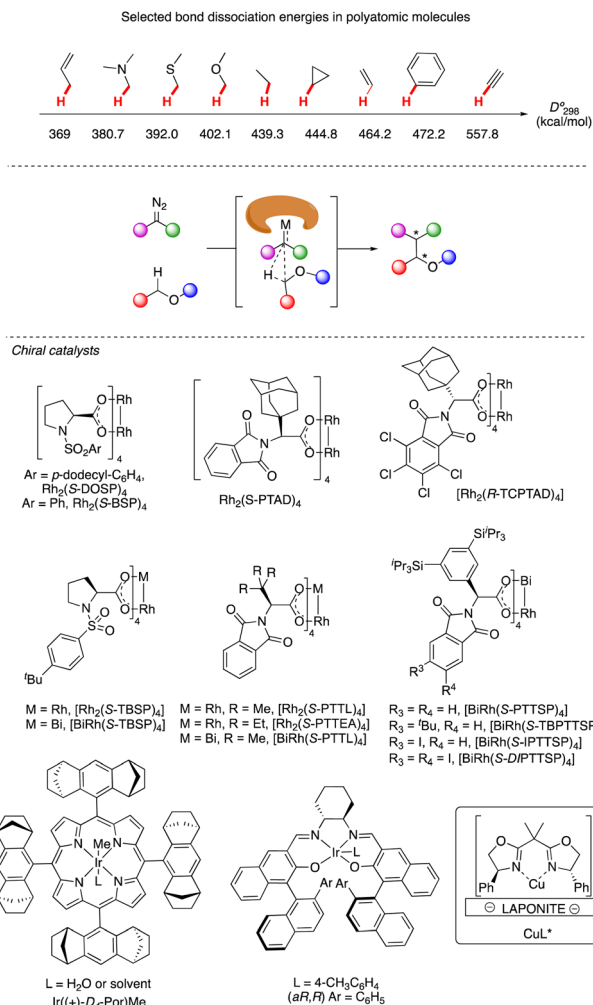
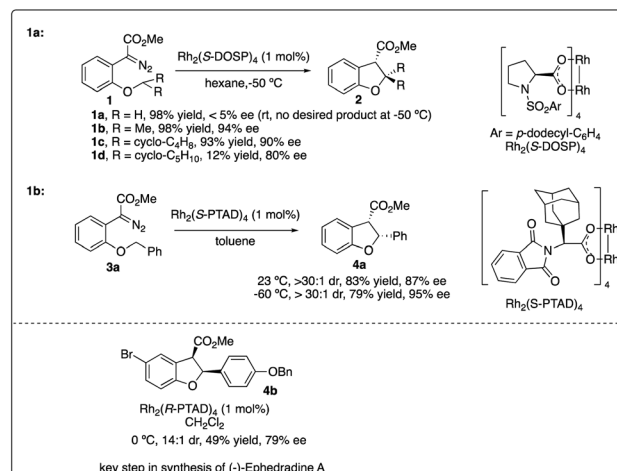



Fig. 2 Representative catalysts for α -C-H bond carbenoid insertion of ether.

dihydrobenzofuran **2** with high enantioselectivity using the same robust catalyst (Scheme 1a).¹⁴ Through the exploration of intramolecular substrates, they investigated the selectivity between tertiary and secondary sites, highlighting the importance of both the site of C-H insertion and the catalyst in facilitating effective asymmetric intramolecular C-H insertion reactions.

In 2006, Davies and colleagues^{15a} introduced a novel adamantly variant, Rh₂(S-PTAD)₄, as a backup chiral catalyst to address instances where Rh₂(S-DOSP)₄ exhibited low asymmetric induction. They successfully demonstrated the enhanced ability of Rh₂(S-PTAD)₄ in promoting enantioselective intramolecular C-H insertion of α -phenyldiazoacetate **3a**, serving as a pivotal step in the synthesis of (-)-ephedrine without the need for a chiral auxiliary (Scheme 1b). Furthermore, Davies and Walji developed an immobilization strategy using Argopore resin to heterogenize chiral rhodium catalysts, enabling their application in asymmetric intramolecular insertion reactions.^{15b} This strategy induced similar reactivity and stereoselectivity as their homogeneous counterparts, facilitating the recycling of rhodium catalysis without compromising catalytic efficiency or stereoselectivity.



Scheme 1 Enantioselectivity intramolecular C-H insertion reactions reported by Davies group.

Chiral dirhodium carboxamide (e.g., Rh₂(5S-MEPY)₄) and carboxylate (such as Rh₂(S-DOSP)₄) catalysts have been demonstrated as efficient catalysts to construct optically active molecules by the enantioselective intramolecular C-H insertion reactions. Subsequently, Hashimoto and colleagues¹⁶ identified Rh₂(S-PTTL)₄ (referred to as Hashimoto's catalyst) as the optimal catalysis for the enantioselective C-H insertion reaction of α -phenyldiazoacetate **5** (Scheme 2). Substrates bearing with a benzene ring consistently yielded excellent *cis/trans* ratios and high ee values (**6f-6g**), while those with simple methine or

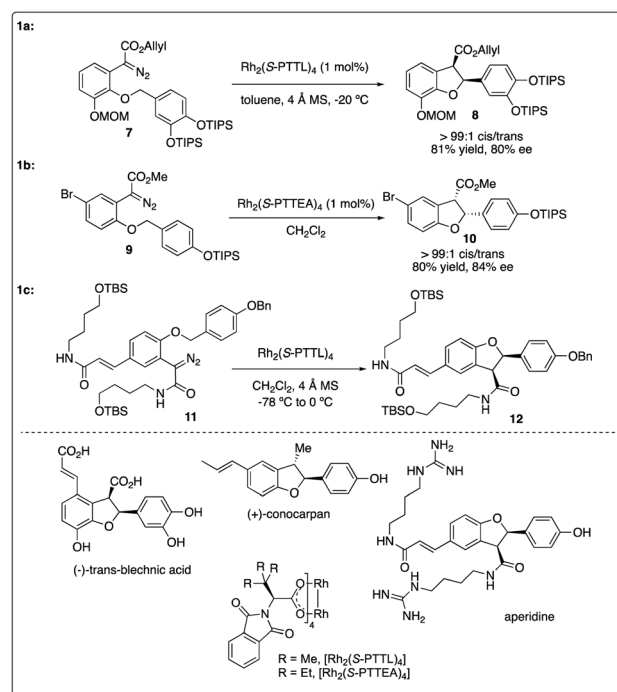

Scheme 2 Enantioselectivity intramolecular C-H insertion reactions reported by Hashimoto group.



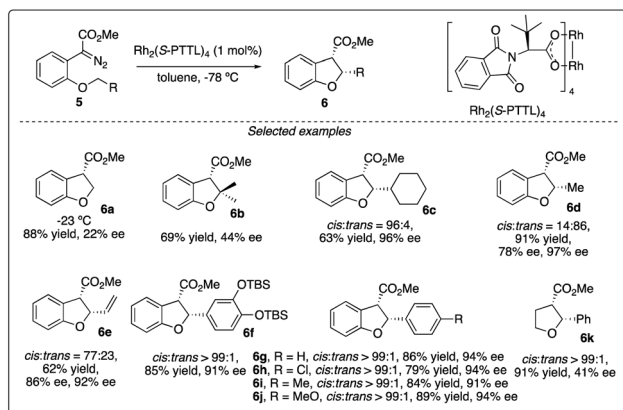

Scheme 3 Key step in natural product total synthesis reported by Hashimoto group and Wakimoto group.

methyl groups resulted in disappointment outcomes (**6a-d**). Notably, the product containing a 3,4-(TBSO)₂C₆H₃ group (**6f**) features an interesting motif found in dihydrobenzofuran-type neolignan blechnic acid. This motif was exploited in their following work on the asymmetric total synthesis of (-)-*trans*-blechnic acid, wherein they modified the rhodium catalyzed insertion reaction reported earlier (Scheme 3a).¹⁷ Additionally, aliphatic substrates were tested, yielding excellent diastereoselectivity, high yields and moderate enantioselectivity under standard reaction conditions (**6k**).

In 2009, Hashimoto and colleagues achieved the asymmetric synthesis of (+)-conocarpan with excellent diastereoselectivity and good enantioselectivity by employing Rh₂(*S*-PTTEA)₄-catalyzed intramolecular C–H insertion reaction of diazo ester **9** as the key step (Scheme 3b).¹⁸ 2011, Wakimoto and coworkers reported the total synthesis of aperiodine, wherein the key carbenoid insertion step was catalyzed Hashimoto's catalyst Rh₂(*S*-PTTL)₄, affording the product in 75% yield and completely stereoselective manner (Scheme 3c).¹⁹

Sometimes, the use of a chiral auxiliary alone may not suffice to achieve the necessary asymmetric induction in rhodium-catalyzed C–H carbenoid insertion reactions. To achieve good enantioselectivity in the synthesis of nature products, double asymmetric induction is frequently employed. Fukuyama and colleagues reported the Rh₂(*S*-DOSP)₄-catalyzed key enantioselective synthesis step of (-)-ephedradine A by utilizing intramolecular C–H insertion of diazoacetate bearing a chiral auxiliary, resulting in the formation of a *trans*-dihydrobenzofuran with excellent diastereoselectivity (Scheme 4a).²⁰ Subsequently, they employed a similar strategy combining a chiral rhodium catalyst and chiral auxiliary to access the asymmetric synthesis of (-)-serotobenine (Scheme 4b).²¹

Recently, Yu and Wang realized the intramolecular C–H insertion step of the enantioselective synthesis of (+)-lithospermic acid by combining Davies's catalyst Rh₂(*S*-DOSP)₄ and Fukuyama's chiral auxiliary, achieving good yield and diastereoselectivity (Scheme 4c).²²

Additionally, Shaw reported Rh₂(*R*-PTAD)₄-catalyzed enantioselective intramolecular C–H insertion reactions of donor-

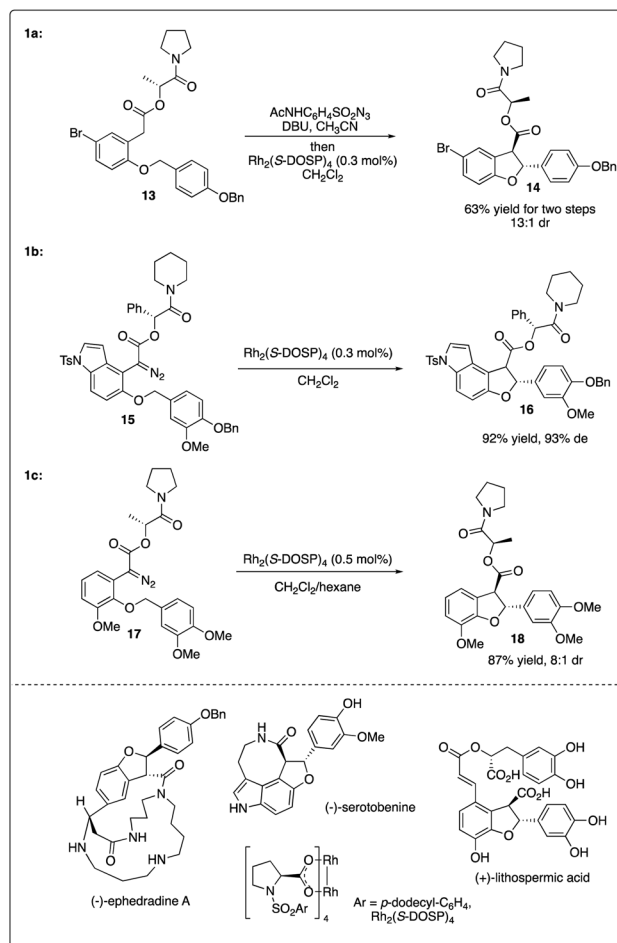

Scheme 4 Key steps in natural product total synthesis combining with chiral auxiliary and chiral rhodium strategy.

donor carbenoid with very high stereoselectivity and good to excellent enantioselectivity (Scheme 5). They developed two unique reaction conditions to achieve the oxidation and insertion reactions step by step or in one-pot from hydrazone **19**. This methodology was successfully applied to the asymmetric synthesis of *E*- δ -viniferin.²³

Very recently, Kan and colleagues constructed the dihydrobenzofuran ring **26** of natural product sophoraflavanone H *via* Rh₂(*S*-DOSP)₄-catalyzed asymmetric C–H insertion reaction of donor-donor carbinoid **25**, achieving excellent yield and moderate enantioselectivity. Interestingly, the enantioselectivity of the dihydrobenzofuran **26** could be enhanced by introducing a methyl ether, albeit the removal of which posed challenges (Scheme 6).²⁴

2.2 Synthesis of chromanones and pyran

The efficiency of asymmetric intramolecular carbenoid C–H insertion has been demonstrated to preferentially produce five and six-membered rings. In 1992, McKerver and Ye reported Rh₂(*S*-BSP)₄-catalyzed asymmetric C–H insertion reaction of ketocarbenoids, leading to the formation of chromanones **28** in excellent yields and good ee values (Scheme 7a).²⁵ In 2015,



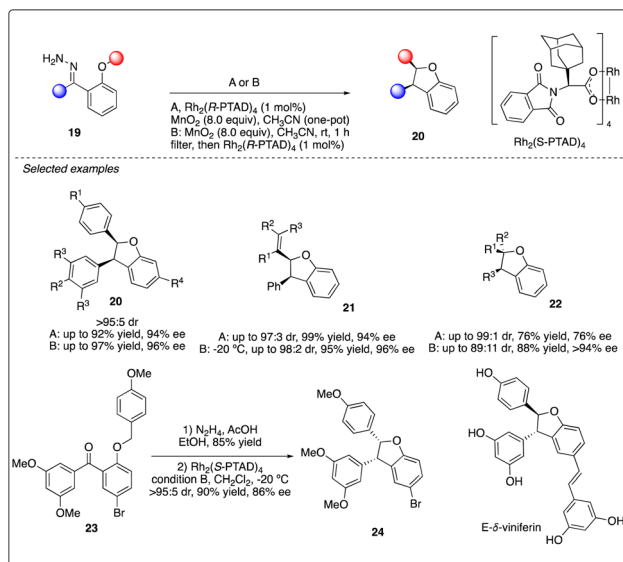

Scheme 5 Enantioselective intramolecular C–H insertion reactions of donor–donor carbenoid and key step in total synthesis of *E*- δ -viniferin.

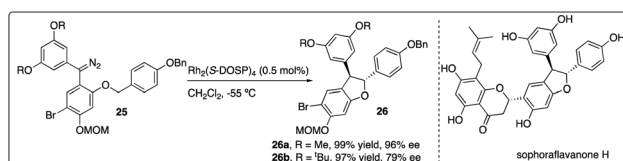

Scheme 6 Key step in total synthesis of sophoraflavanone H by Kan group.

Hashimoto and colleagues achieved the $\text{Rh}_2(\text{S-PTTL})_4$ -catalyzed asymmetric 1,6-C–H insertion reaction of α -diazo esters **30** by slightly modifying the substrate structure. This method was preferred over Z-alkene formation or tandem ylide formation-rearrangement and 1,2-hydride shift product (Scheme 7b).²⁶

2.3 Synthesis of β -lactones

Four-membered rings like β -lactones are common yet unique structural motifs in natural products and pharmaceuticals, posing a challenge but accessible *via* intramolecular C–H carbene insertion. In 2013, Che and coworkers reported the use of $[\text{Ir}((+)\text{-D4-Por})\text{Me}]$, supported by D4-Halterman porphyrin ligand, as iridium catalysis. They successfully achieved enantioselective intramolecular carbene insertion into C–H bonds of α -diazoesters **34**, yielding a series of aromatic substituted *cis*- β -lactones **35** with good stereoselectivity and enantioselectivities (Scheme 8).²⁷

Davies and colleagues discovered that the *ortho*-substituent (such as halo and trifluoromethyl) on aryldiazoacetate **36** could interfere with intermolecular C–H insertion, thereby enhancing the formation of β -lactone **37**. Firstly, they developed asymmetric methyl C–H insertion catalyzed by $\text{Rh}_2(\text{S-TCPTAD})_4$, achieving good to excellent enantioselectivities. Secondly, they

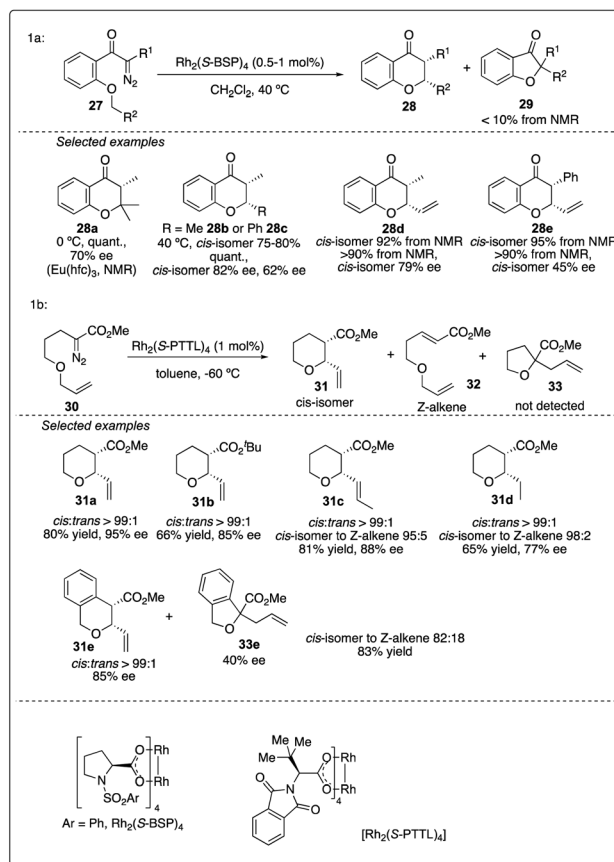

Scheme 7 Chromanones and pyran synthesis *via* enantioselectivity intramolecular C–H insertion reactions.

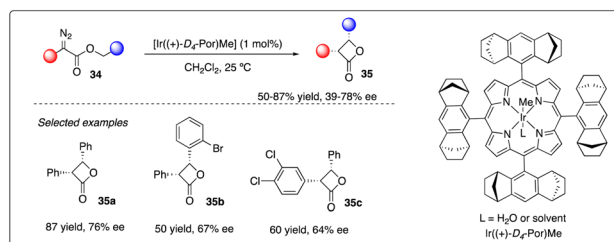

Scheme 8 Synthesis of β -lactones *via* iridium catalyzed asymmetric C–H insertion reactions by Che group.

switched to $\text{Rh}_2(\text{S-TCPTTL})_4$ to modify the *cis/trans* selectivity of methylene C–H insertion (Scheme 9).²⁸ Interestingly, when ethyl aryldiazoacetate **38b** was employed as substrates, *trans*-formed product **39b** was obtained with good to excellent enantioselectivity. However, when electron-donating methyl or methoxyl group (Scheme 10a and b) were introduced to the *para*-position of the benzyl ester, the desired C–H insertion product **42** was unstable to undergo CO_2 extrusion, similar to previous findings reported by the same group (Scheme 10c). They proposed the mechanism for Z-product formation, suggesting that the silicon could direct the C–H insertion away from the more sterically hindered α -position and facilitate the polarization of the lactone C–O bond.²⁹



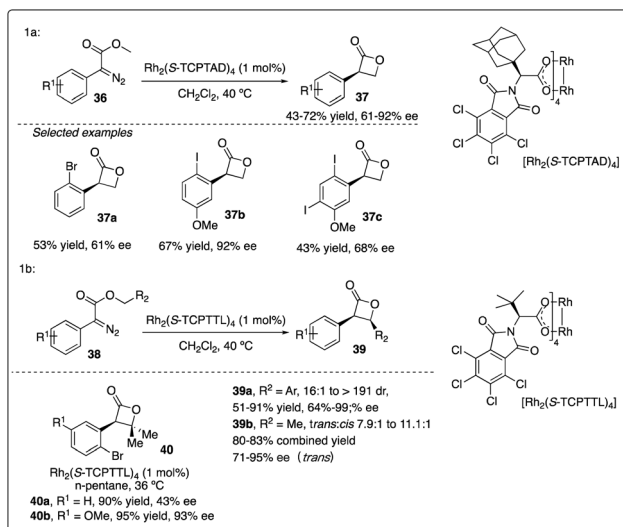

Scheme 9 Synthesis of β -lactones *via* rhodium catalyzed asymmetric C–H insertion reactions by Davies group.

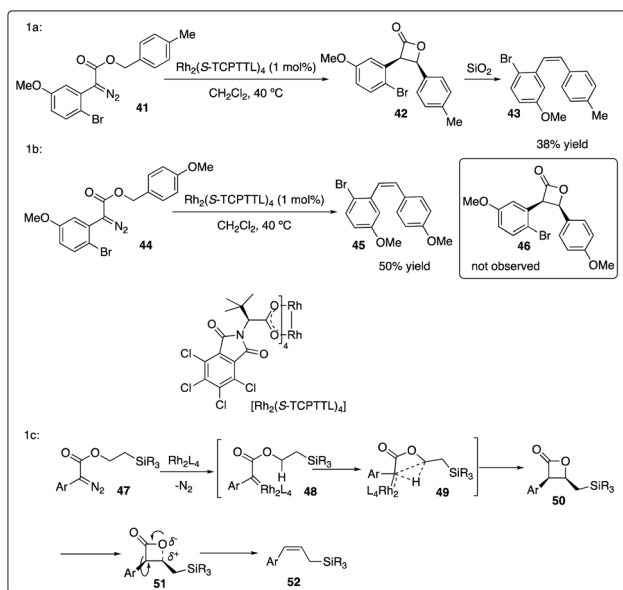

Scheme 10 Control reactions and proposal mechanism for Z-product formation by Davies group.

3. Intermolecular α -C–H bond carbenoid insertion of ether

The challenge of achieving asymmetric intermolecular carbenoid C–H insertion persisted until the emergence of a robust catalyst system capable of overcoming these major obstacles in organic synthesis. Based upon their previous study on $\text{Rh}_2(\text{S-DOSP})_4$ -catalyzed asymmetric cyclopropanations with diazoacetates, Davies and Hansen proposed utilizing the decomposition of aryldiazoacetates **53** by $\text{Rh}_2(\text{S-DOSP})_4$ to enable asymmetric intermolecular C–H insertions. Employing this strategy, they successfully realized the C–H insertion of

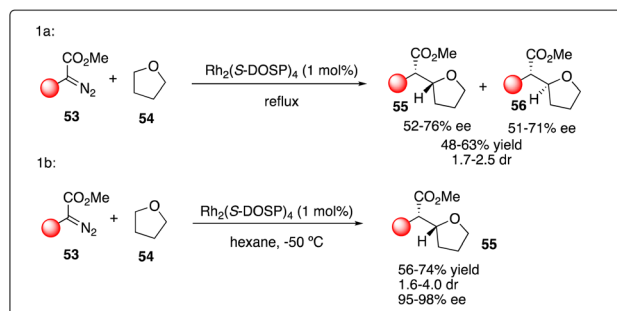

Scheme 11 Enantioselective intermolecular C–H insertion reactions of donor–accepter carbenoid and THF by Davies group.

aryldiazoacetates **53** with tetrahydrofuran **54** as a carbenoid trap, yielding a series of products with moderate dr values and good enantioselectivity (Scheme 11a).³⁰ Davies and Hansen also proposed the asymmetric induction model by $\text{Rh}_2(\text{S-DOSP})_4$ to predict the configuration in the product. Subsequently, they optimized the reaction conditions,³¹ discovering that the degassing of the solvent significantly increased the reactivity and the enantioselectivity. Furthermore, they achieved further improvement in enantioselectivity by employing nonpolar solvents such as THF (2 equiv.) in hexane, highlighting the remarkable selectivity of the carbenoid in the presence of hexane (Scheme 11b). Additionally, they investigated the kinetic isotope effect for the C–H insertion process through competition experiments between d8-tetrahydrofuran and tetrahydrofuran.

Subsequently, they delved into the comprehensive chemistry of rhodium carbenoid-induced C–H insertion of silyl ethers **56** to synthesize silyl-protected β -hydroxy esters **58** with excellent regio-, diastereo-, and enantioselectivity (Scheme 12a).³² They particular emphasized the critical requirement for selectivity by utilizing donor/acceptor-substituted carbenoids **57** and catalytic rhodium prolinato complex $\text{Rh}_2(\text{S-DOSP})_4$. Additionally, they discovered that the C–H insertion reaction is facilitated with the *trans*-allyl silyl ether and summarized the general reactivity trends (Scheme 12b). They elucidated that a silyl allyl ether is highly activated for C–H insertion, while acetoxy group

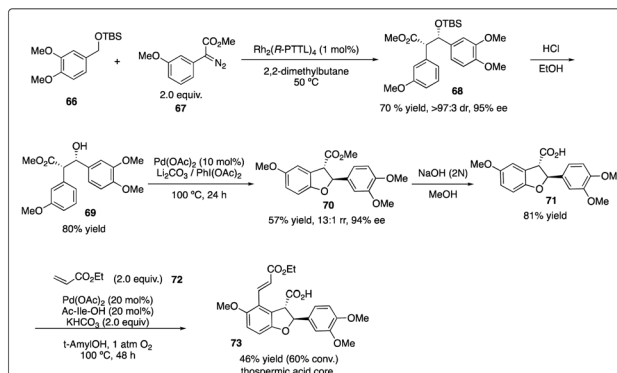

Scheme 12 Enantioselective intermolecular C–H insertion reaction for the synthesis of thospermic acid core by Davies and Yu group.



exerts a deactivating effect presumably due to its electron-withdrawing nature. Despite consistently low enantioselectivity observed in the C–H insertion of benzyl silyl ethers **59** by $\text{Rh}_2(\text{S-DOSP})_4$ (10–35% ee), and moderately high enantioselectivity achieved through chiral auxiliary mediated C–H functionalization reactions using ethyl (*S*)-lactate-based aryldiazoacetate (79–88% de, 68–85% ee), they ultimately attained the best results (91–95% de, 95–98% ee) by employing Hashimoto's $\text{Rh}_2(\text{S-PTTL})_4$ catalyst.³³

Recently, Davies and Sigman and their coworkers discovered that the site- and stereoselective C–H functionalization at α , γ , δ and even more distal positions to the siloxy ethers could be achieved by leveraging the preferences of $\text{Rh}_2(\text{R-TCPTAD})_4$ and $\text{Rh}_2(\text{S-2-Cl-5-BrTPCP})_4$ catalyst, yielding products with good to excellent enantioselectivity (Scheme 12c).³⁴ Additionally, they developed a machine learning classification model to predict the major C–H functionalization site based on catalyst propensity and substrate electronics.

In 2013, Davies and Yu and their coworkers achieved a highly regio-, diastereo-, and enantioselective synthesis of dihydrobenzofurans **73** (the core of the thospermic acid family) involving three distinct C–H functionalization steps. Particularly noteworthy was a rhodium-catalyzed enantioselective intermolecular C–H insertion reaction (Scheme 13).^{35a} Later, in a collaboration between the Sorensen and Yu groups with the Davies groups, another two sequential C–H functionalization reactions were described for the synthesis of the indoxamycin family core **77** with good yield and highly regio- and diastereoselectivity (Scheme 14).^{35b}

The electronic stabilization of the transition state during C–H activation favored α to alkoxy or silyloxy groups in a concerted non-synchronous manner, as demonstrated with excellent enantioselectivity and regioselectivity results. However, the Davies group observed a dramatical site selectivity when alkyl ethers like DME **78**, Et_2O , and unsymmetric ethers were used.^{36a} In comparison to a mixture obtained with $\text{Rh}_2(\text{R-DOSP})_4$ catalyst, the $\text{Rh}_2(\text{R-BPCP})_4$ catalyzed C–H carbenoid insertion reaction selectively targeted the primary C–H bond with moderate enantioselectivity (Scheme 15).^{36b}

Later, Davies and Gupta optimized the aforementioned C–H insertion reaction of diazo compounds **86** with a 2,2,2-trichloroethyl (TCE) ester as the acceptor group. They discovered that the TCE ester could enhance reactivity and improve the levels of regioselectivity and enantioselectivity between primary and secondary C–H bonds (Scheme 16).³⁷

Recently, Davies, Musaev and Berry and their coworkers reported the first chiral [RhBi] paddlewheel catalyst, [BiRh(S-

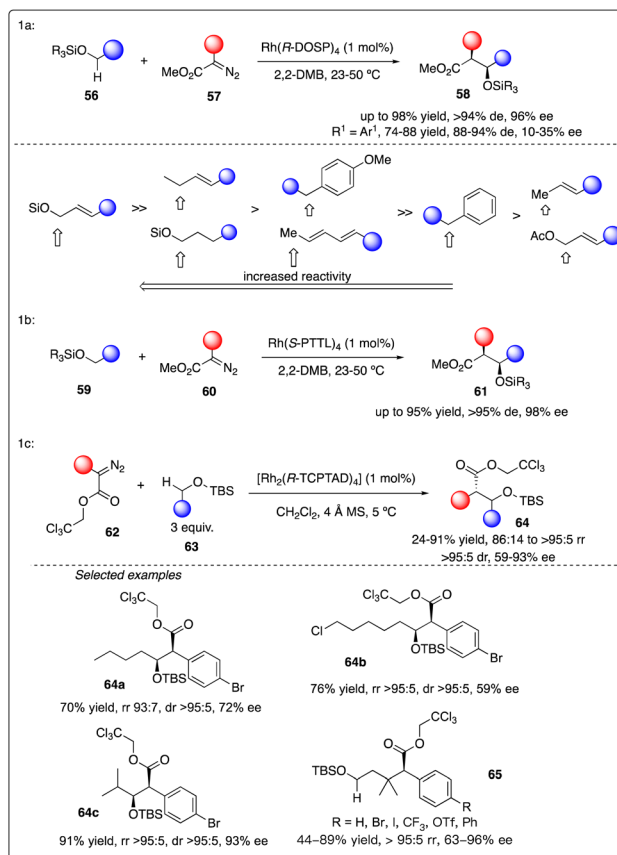

Scheme 14 Enantioselective intermolecular C–H insertion reactions of donor–accepter carbenoid and silyl ether by Davies group.

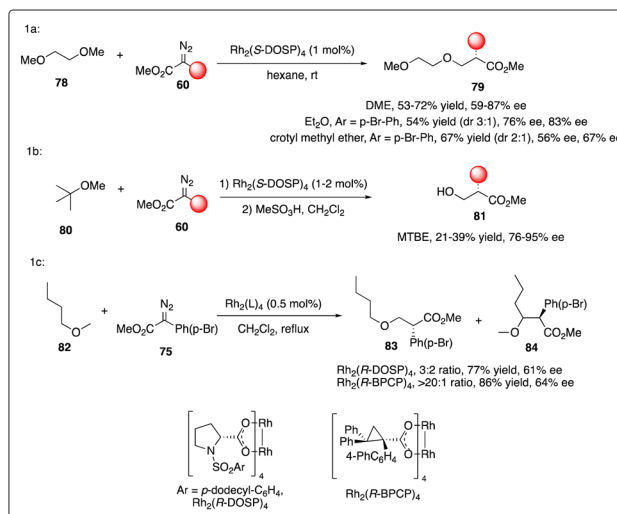

Scheme 15 Enantioselective intermolecular C–H insertion reactions of donor–accepter carbenoid and primary methine by Davies group.

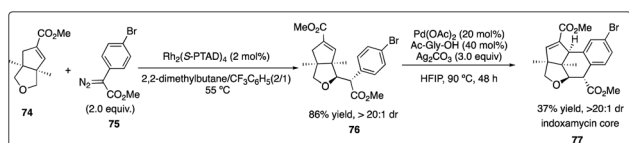

Scheme 13 Enantioselective intermolecular C–H insertion reaction for the synthesis of indoxamycin core by Sorensen group.

TBSP)₄], and applied them to asymmetric cyclopropanation and C–H functionalization.³⁸ Later, Fürstner and his coworkers designed a new type of [RhBi] paddlewheel catalysts³⁹ and found it to be exceedingly effective in site-selective C–H functionalization with ethers (Scheme 17).⁴⁰ Their rationale catalyst design



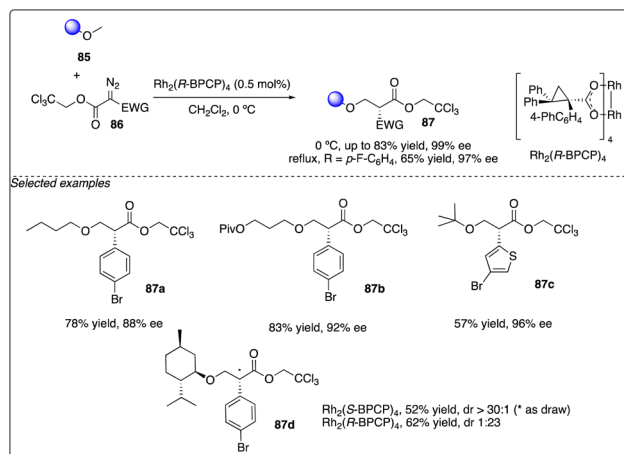

Scheme 16 Enantioselective intermolecular C–H insertion reactions of donor–accepter (TCE) carbenoid and primary methine by Davies group.

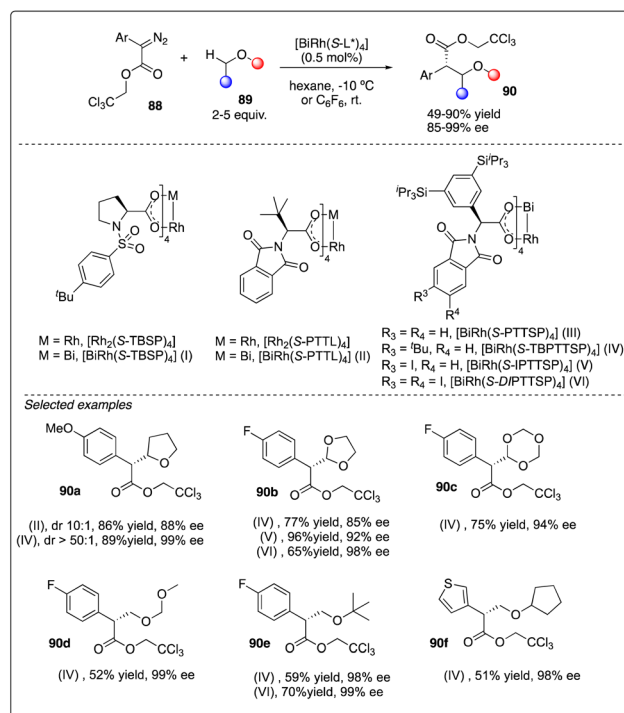

Scheme 17 Enantioselective intermolecular C–H insertion reactions of donor–accepter carbenoid with chiral [RhBi] catalyst by Fürstner group.

involved using phenyl rings carrying lateral $-\text{Si}(\text{iPr})_3$ substituents to replace the *tert*-butyl residues, facilitating a large number of attractive interligand London dispersion interactions.⁴¹

Davies and Jones and their coworkers developed a scalable flow reactor for enantioselective and regioselective rhodium C–H carbene insertion reactions (Scheme 18).⁴² Comparing to conventional batch reactors, the yield, site-selectivity and enantioselectivity of the product in this immobilized dirhodium

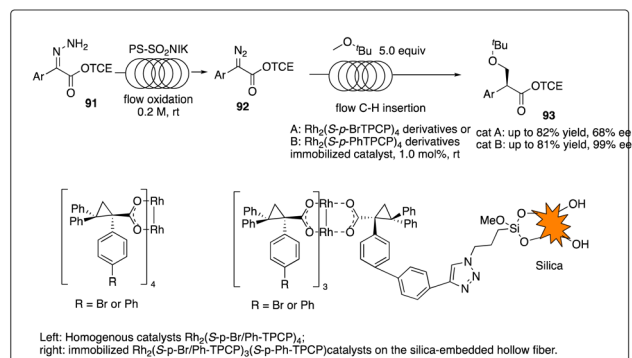

Scheme 18 Enantioselective intermolecular C–H insertion reactions with a scalable flow reactor by Davies and Jones group.

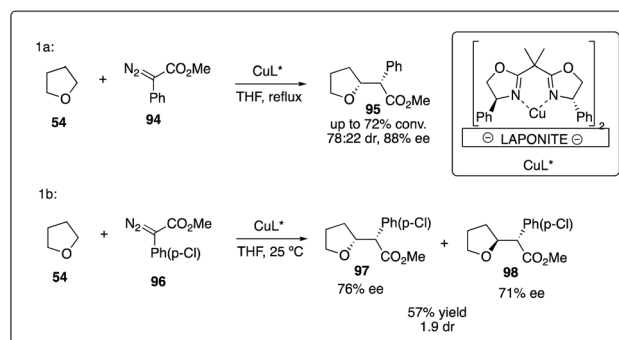

Scheme 19 Enantioselective intermolecular C–H insertion reactions of donor–accepter carbenoid and THF catalyzed by copper complex.

hollow-fiber flow reactor were similar but more effective, scalable, recyclable.

Copper complex was the first transition metal catalyst proposed to promote the decompositions of carbenoids.⁴ However, it was only recently that the asymmetric version for the α -C–H activation/carbenoid insertion of ethers was realized. In 2007, Fraile, Mayoral and coworkers reported an immobilized box-Cu complex catalyzed asymmetric insertion of a carbene into C–H bonds of THF with good enantioselectivity (Scheme 19a).⁴³ This bis(oxazoline)-copper complex supported by Laponite could be recovered and reused with good reactivity and enantioselectivity control, demonstrating catalytic stability over three more cycles. Comparing with homogeneous box-copper complexes for carbene insertion reactions, the immobilized copper complexes could achieve higher chemoselectivities and stereoselectivities than normally used rhodium catalyst (Scheme 19b).⁴⁴

Katsuki and Suematsu discovered the iridium(III)-salen complexes show promising results in asymmetric carbenoid C–H insertion reactions (Scheme 20a). All the aryldiazoacetates **99** were well tolerated with good to excellent diastereoselectivity and enantioselectivity. They also achieved the first example of asymmetric intermolecular insertion with alkyl-substituted diazoacetate.⁴⁵ Later, Che and coworkers reported chiral iridium porphyrin catalyzed asymmetric C–H carbene C–H



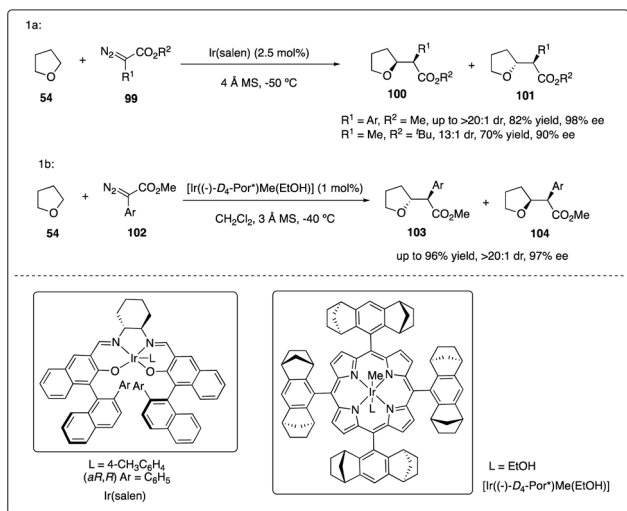

Scheme 20 Enantioselective intermolecular C–H insertion reactions of donor–accepter carbenoid and THF catalysed by iridium complex.

insertion reactions with good to excellent diastereoselectivity, enantioselectivity and product turnovers (Scheme 20b).⁴⁶

4. Summary and outlook

Catalytic asymmetric α -C–H bond functionalization of ether *via* carbenoid insertion has made enormous progress over the past decade. Effective asymmetric catalytic systems, including various chiral metal catalysts, have already been established for the enantioselective carbenoid insertion into the C–H bond adjacent to the oxygen atom in a variety of structurally diverse ether substrates. This has led to the generation of various enantioenriched highly-functionalized oxygen-containing structural motifs, enabling corresponding applications in asymmetric synthesis of bioactive natural products.

Despite these elegant advancements, challenges still remain and further exploration of catalytic enantioselective insertion of carbenoids into α -C–H bond functionalization of ethers is highly in demand. Currently, rhodium based asymmetric catalytic systems are the most commonly employed and well-studied, however, asymmetric catalytic systems based on more readily available transition metals, such as copper, iron, and cobalt, which might enhance the value of asymmetric C–H functionalization reactions, are underexplored and should draw more attention from the chemistry community. In addition, researches in this area is likely to focus on novel ligand families design and development to explore new type of substrates and transformations with a high level of chemo-, regio- and/or stereo-selectivities. Moreover, the discovery and further development of carbenoid insertion transformations with the *in situ* generated diazo substrates from more accessible precursors, like hydrazones, would greatly promote the practicality and versatility of current asymmetric C–H functionalization methodologies. Despite these challenges, we believe that catalytic asymmetric carbenoid insertion into α -C–H bond of ether will undoubtedly witness improvement and meet the requirements

for more practical applications in the synthesis of pharmaceuticals or natural products in the future.

Conflicts of interest

There are no conflicts to declare.

Acknowledgements

We gratefully acknowledge the National Natural Science Foundation of China (22201308) and China Postdoctoral Science Foundation funded project (2022M713510) is acknowledged. We appreciated the advice from Dr Shou-Guo Wang, Shenzhen Institutes of Advanced Technology, Chinese Academy of Sciences.

References

- (a) J. H. Docherty, T. M. Lister, G. McArthur, M. T. Findlay, P. Domingo-Legarda, J. Kenyon, S. Choudhary and I. Larrosa, Transition-metal-catalyzed C–H bond activation for the formation of C–C bonds in complex molecules, *Chem. Rev.*, 2023, **123**, 7692–7760; (b) M. I. Lapuh, S. Mazeh and T. Besset, Chiral transient directing groups in transition-metal-catalyzed enantioselective C–H bond functionalization, *ACS Catal.*, 2020, **10**, 12898–12919.
- (a) J. V. Santiago and A. H. L. Machado, Enantioselective carbenoid insertion into C(sp³)–H bonds, *Beilstein J. Org. Chem.*, 2016, **12**, 882–902; (b) S. Gandhi, Catalytic enantioselective cross dehydrogenative coupling of sp³ C–H of heterocycles, *Org. Biomol. Chem.*, 2019, **17**, 9683; (c) S.-Y. Zhang, F.-M. Zhang and Y.-Q. Tu, Direct Sp³ α -C–H activation and functionalization of alcohol and ether, *Chem. Soc. Rev.*, 2011, **40**, 1937–1949.
- O. Silberrad and C. S. Roy, XXIV.—Gradual decomposition of ethyl diazoacetate, *J. Chem. Soc., Trans.*, 1906, **89**, 179–182.
- (a) P. Yates, The copper-catalyzed decomposition of diazoketones, *J. Am. Chem. Soc.*, 1952, **74**, 5376–5381; (b) L. T. Scott and G. J. DeCicco, Intermolecular carbon-hydrogen insertion of copper carbenoids, *J. Am. Chem. Soc.*, 1974, **96**, 322–323.
- (a) M. P. Doyle, R. Duffy, M. Ratnikov and L. Zhou, Catalytic carbene insertion into C–H bonds, *Chem. Rev.*, 2010, **110**, 704–724; (b) B. D. Bergstrom, L. A. Nickerson, J. T. Shaw and L. W. Souza, Transition metal catalyzed insertion reactions with donor/donor carbenes, *Angew. Chem., Int. Ed.*, 2021, **60**, 6864–6878.
- (a) T. Aneja, M. Neetha, C. M. A. Afsina and G. Anilkumar, Progress and prospects in copper-catalyzed C–H functionalization, *RSC Adv.*, 2020, **10**, 34429–34458; (b) O. Daugulis, H. Do and D. Shabashov, Palladium- and copper-catalyzed arylation of carbon–hydrogen bonds, *Acc. Chem. Res.*, 2009, **42**, 1074–1086.
- S. Kumar, S. Nunewar, S. Oluguttula, S. Nanduri and V. Kanchupalli, Recent advances in Rh(III)/Ir(III)-catalyzed C–H functionalization/annulation *via* carbene migratory insertion, *Org. Biomol. Chem.*, 2021, **19**, 1438–1458.



- 8 (a) C.-X. Liu, S.-Y. Yin, F. Zhao, H. Yang, Z. Feng, Q. Gu and S.-L. You, Rhodium-catalyzed asymmetric C–H functionalization reactions, *Chem. Rev.*, 2023, **123**, 10079–10134; (b) D. A. Colby, R. G. Bergman and J. A. Ellman, Rhodium-catalyzed C–C bond formation *via* heteroatom-directed C–H bond activation, *Chem. Rev.*, 2010, **110**, 624–655.
- 9 (a) S. Barranco, J. Zhang, S. López-Resano, A. Casnati and M. H. Pérez-Temprano, Transition metal-catalysed directed C–H functionalization with nucleophiles, *Nat. Synth.*, 2022, **1**, 841–853; (b) Y. He, Z. Huang, K. Wu, J. Ma, Y.-G. Zhou and Z. Yu, Recent advances in transition-metal-catalyzed carbene insertion to C–H bonds, *Chem. Soc. Rev.*, 2022, **51**, 2759–2852; (c) F. Kakiuchi and N. Chatani, Catalytic methods for C–H bond functionalization: application in organic synthesis, *Adv. Synth. Catal.*, 2003, **345**, 1077–1101; (d) T. Lyons and M. Sanford, Palladium-catalyzed ligand-directed C–H functionalization reactions, *Chem. Rev.*, 2010, **110**, 1147–1169; (e) X. Chen, K. M. Engle, D. H. Wang and J.-Q. Yu, Palladium(II)-catalyzed C–H activation/C–C cross-coupling reactions: versatility and practicality, *Angew. Chem., Int. Ed.*, 2009, **48**, 5094–5115; (f) A. A. O. Sarhan and C. Bolm, Iron(III) chloride in oxidative C–C coupling reactions, *Chem. Soc. Rev.*, 2009, **38**, 2730–2744; (g) C. L. Sun, B. J. Li and Z. J. Shi, Direct C–H transformation *via* iron catalysis, *Chem. Rev.*, 2011, **111**, 1293–1314; (h) T. Kitamura, Transition-metal-catalyzed hydroarylation reactions of alkynes through direct functionalization of C–H bonds: a convenient tool for organic synthesis, *Eur. J. Org. Chem.*, 2009, 1111–1125; (i) Y. Qian, J. Tang, X. Zhou, J. Luo, X. Yang, Z. Ke and W. Hu, Enantioselective multifunctionalization with Rh carbynoids, *J. Am. Chem. Soc.*, 2023, **145**, 26403–26411.
- 10 (a) J. Adams, M.-A. Poupart, L. Grenier, C. Schaller, N. Ouimet and R. Frenette, Rhodium acetate catalyzes the addition of carbenoids α - to ether oxygens, *Tetrahedron Lett.*, 1989, **30**, 1749–1752; (b) P. Wang and J. Adams, Model studies of the stereoelectronic effect in Rh(II) mediated carbenoid C–H insertion reactions, *J. Am. Chem. Soc.*, 1994, **116**, 3296–3305.
- 11 (a) M. P. Doyle, A. van Oeveren, L. J. Westrum, M. N. Protopopova and T. W. Clayton Jr, Asymmetric synthesis of lactones with high enantioselectivity by intramolecular carbon-hydrogen insertion reactions of alkyl diazoacetates catalyzed by chiral rhodium(II) carboxamides, *J. Am. Chem. Soc.*, 1991, **113**, 8982–8984; (b) H. M. L. Davies, P. R. Bruzinski, D. H. Lake, N. Kong and M. J. Fall, Asymmetric cyclopropanations by rhodium(II) *N*-(arylsulfonyl)prolinate catalyzed decomposition of vinyl diazomethanes in the presence of alkenes. Practical enantioselective synthesis of the four stereoisomers of 2-phenylcyclopropan-1-amino acid, *J. Am. Chem. Soc.*, 1996, **118**, 6897–6907.
- 12 (a) H. M. L. Davies and K. Liao, Dirhodium tetracarboxylates as catalysts for selective intermolecular C–H functionalization, *Nat. Rev. Chem.*, 2019, **3**, 347–360; (b) R. Wu, D. Zhu and S. Zhu, Dirhodium: carbene transformations and beyond, *Org. Chem. Front.*, 2023, **10**, 2849–2878; (c) H. Yu and F. Xu, Non-noble metal-catalyzed cross-dehydrogenation coupling (CDC) involving ether α -C(sp³)-H to construct C–C bonds, *Beilstein J. Org. Chem.*, 2023, **19**, 1259–1288.
- 13 (a) Y.-R. Luo, *Comprehensive Handbook of Chemical Bond Energies*, CRC Press, 2007; (b) Y.-H. Miao, Y.-H. Hu, J. Yang, T. Liu, J. Sun and X.-J. Wang, Natural source, bioactivity and synthesis of benzofuran derivatives, *RSC Adv.*, 2019, **9**, 27510–27540; (c) A. Radadiya and A. Shah, Bioactive benzofuran derivatives: an insight on lead developments, radioligands and advances of the last decade, *Eur. J. Med. Chem.*, 2015, **97**, 356–376.
- 14 H. M. L. Davies, M. V. A. Grazini and E. Aouad, Asymmetric intramolecular C–H insertions of aryldiazoacetates, *Org. Lett.*, 2001, **3**, 1475–1477.
- 15 (a) R. P. Reddy, G. H. Lee and H. M. L. Davies, Dirhodium tetracarboxylate derived from adamantylglycine as a chiral catalyst for carbenoid reactions, *Org. Lett.*, 2006, **8**, 3437–3440; (b) H. M. L. Davies and A. M. Walji, Universal strategy for the immobilization of chiral dirhodium catalysts, *Org. Lett.*, 2005, **7**, 2941–2944.
- 16 H. Saito, H. Oishi, S. Kitagaki, S. Nakamura, M. Anada and S. Hashimoto, Enantio- and diastereoselective synthesis of *cis*-2-aryl-3-methoxycarbonyl-2,3-dihydrobenzofurans *via* the Rh(II)-catalyzed C–H insertion process, *Org. Lett.*, 2002, **4**, 3887–3890.
- 17 M. Ito, R. Namie, J. Krishnamurthi, H. Miyamae, K. Takeda, H. Nambu and S. Hashimoto, Asymmetric total synthesis of (–)-*trans*-blechnic acid *via* rhodium(II)-catalyzed C–H insertion and palladium(II)-catalyzed C–H olefination reactions, *Synlett*, 2014, **25**, 288–292.
- 18 Y. Natori, H. Tsutsui, N. Sato, S. Nakamura, H. Nambu, M. Shiro and S. Hashimoto, Asymmetric synthesis of neolignans (–)-*epi*-conocarpan and (+)-conocarpan *via* Rh(II)-catalyzed C–H insertion process and revision of the absolute configuration of (–)-*epi*-conocarpan, *J. Org. Chem.*, 2009, **74**, 4418–4421.
- 19 T. Wakimoto, K. Miyata, H. Ohuchi, T. Asakawa, H. Nukaya, Y. Suwa and T. Kan, Enantioselective total synthesis of aperiidine, *Org. Lett.*, 2011, **13**, 2789–2791.
- 20 W. Kurosawa, T. Kan and T. Fukuyama, Stereocontrolled total synthesis of (–)-ephedradine A (orantine), *J. Am. Chem. Soc.*, 2003, **125**, 8112–8113.
- 21 Y. Koizumi, H. Kobayashi, T. Wakimoto, T. Furuta, T. Fukuyama and T. Kan, Total synthesis of (–)-serotobenine, *J. Am. Chem. Soc.*, 2008, **130**, 16854–16855.
- 22 D. H. Wang and J. Q. Yu, Highly convergent total synthesis of (+)-lithospermic acid *via* a late-stage intermolecular C–H olefination, *J. Am. Chem. Soc.*, 2011, **133**, 5767–5769.
- 23 (a) C. Soldi, K. N. Lamb, R. A. Squitieri, M. González-López, M. J. Di Maso and J. T. Shaw, Enantioselective intramolecular C–H insertion reactions of donor–donor metal carbenoids, *J. Am. Chem. Soc.*, 2014, **136**, 15142–15145; (b) J. T. Shaw, C–H insertion reactions of donor/donor carbenes: inception, investigation, and insights, *Synlett*, 2020, **31**, 838–844.



- 24 H. Murakami, T. Asakawa, Y. Muramatsu, R. Ishikawa, A. Hiza, Y. Tsukaguchi, Y. Tokumaru, M. Egi, M. Inai, H. Ouchi, F. Yoshimura, T. Taniguchi, Y. Ishikawa, M. Kondo and T. Kan, Total synthesis of sophoraflavanone h and confirmation of its absolute configuration, *Org. Lett.*, 2020, **22**, 3820–3824.
- 25 (a) M. A. McKerverey and T. Ye, Asymmetric synthesis of substituted chromanones *via* C–H insertion reactions of α -diazoketones catalysed by homochiral rhodium(II) carboxylates, *J. Chem. Soc., Chem. Commun.*, 1992, 823–824; (b) T. Ye, C. Fernández García and M. A. McKerverey, Chemoselectivity and stereoselectivity of cyclisation of α -diazocarbonyls leading to oxygen and sulfur heterocycles catalysed by chiral rhodium and copper catalysts, *J. Chem. Soc., Perkin Trans.*, 1995, **1**, 1373–1379; (c) A. Rosales, I. Rodríguez-García, C. López-Sánchez, M. Álvarez-Corral and M. Muñoz-Dorado, Solvent influence in the Rh-catalyzed intramolecular 1,6 C–H insertions: a general approach to the chromane and flavanone skeletons, *Tetrahedron*, 2011, **67**, 3071–3075.
- 26 M. Ito, Y. Kondo, H. Nambu, M. Anada, K. Takeda and S. Hashimoto, Diastereo- and enantioselective intramolecular 1,6-C–H insertion reactions of α -diazo esters catalyzed by chiral dirhodium(II) carboxylates, *Tetrahedron Lett.*, 2015, **56**, 1397–1400.
- 27 J.-C. Wang, Y. Zhang, Z.-J. Xu, V. K.-Y. Lo and C.-M. Che, Enantioselective intramolecular carbene C–H insertion catalyzed by a chiral iridium(III) complex of D4-symmetric porphyrin ligand, *ACS Catal.*, 2013, **3**, 1144–1148.
- 28 L. Fu, H. Wang and H. M. L. Davies, Role of *ortho*-substituents on rhodium-catalyzed asymmetric synthesis of β -lactones by intramolecular C–H insertions of aryldiazoacetates, *Org. Lett.*, 2014, **16**, 3036–3039.
- 29 D. M. Guptill, C. M. Cohen and H. M. L. Davies, Rhodium(II)-catalyzed stereoselective synthesis of allylsilanes, *Org. Lett.*, 2013, **15**, 6120–6123.
- 30 H. M. L. Davies and T. Hansen, Asymmetric intermolecular carbenoid C–H insertions catalyzed by rhodium(II) (*S*)-*N*-(*p*-dodecylphenyl)sulfonylproline, *J. Am. Chem. Soc.*, 1997, **119**, 9075.
- 31 H. M. L. Davies, T. Hansen and M. R. Churchill, Catalytic asymmetric C–H activation of alkanes and tetrahydrofuran, *J. Am. Chem. Soc.*, 2000, **122**, 3063–3070.
- 32 (a) H. M. L. Davies, E. G. Antoulinakis and T. Hansen, Catalytic asymmetric synthesis of *syn*-aldol products from intermolecular C–H insertions between allyl silyl ethers and methyl aryldiazoacetates, *Org. Lett.*, 1999, **1**, 383–386; (b) H. M. L. Davies and E. G. Antoulinakis, EXT asymmetric catalytic C–H activation applied to the synthesis of *syn*-aldol products, *Org. Lett.*, 2000, **2**, 4153–4156; (c) H. M. L. Davies, R. E. J. Beckwith, E. G. Antoulinakis and Q. Jin, New strategic reactions for organic synthesis: catalytic asymmetric C–H activation α to oxygen as a surrogate to the aldol reaction, *J. Org. Chem.*, 2003, **68**, 6126.
- 33 (a) H. M. L. Davies and J. R. Manning, Catalytic C–H functionalization by metal carbenoid and nitrenoid insertion, *Nature*, 2008, **451**, 417; (b) H. M. L. Davies, Recent advances in catalytic enantioselective intermolecular C–H functionalization, *Angew. Chem., Int. Ed.*, 2006, **45**, 6422–6425; (c) H. M. L. Davies, Catalytic enantioselective C–H activation by means of metal-carbenoid-induced C–H insertion, *Chem. Rev.*, 2003, **103**, 2861; (d) H. M. L. Davies, J. Yang and J. Nikolai, Asymmetric C–H insertion of Rh(II) stabilized carbenoids into acetals: A C–H activation protocol as a claisen condensation equivalent, *J. Organomet. Chem.*, 2005, **690**, 6111–6124; (e) H. M. L. Davies, S. J. Hedley and B. R. Bohall, Asymmetric intermolecular C–H functionalization of benzyl silyl ethers mediated by chiral auxiliary-based aryldiazoacetates and chiral dirhodium catalysts, *J. Org. Chem.*, 2005, **70**, 10737–10742.
- 34 Y. T. Boni, R. C. Cammarota, K. Liao, M. S. Sigman and H. M. L. Davies, Leveraging regio- and stereoselective C(sp³)-H functionalization of silyl ethers to train a logistic regression classification model for predicting site-selectivity bias, *J. Am. Chem. Soc.*, 2022, **144**, 15549–15561.
- 35 (a) H. Wang, G. Li, K. M. Engle, J. Q. Yu and H. M. L. Davies, Sequential C–H functionalization reactions for the enantioselective synthesis of highly functionalized 2,3-dihydrobenzofurans, *J. Am. Chem. Soc.*, 2013, **135**, 6774–6777; (b) T. A. Bedell, G. A. B. Hone, D. Valette, J.-Q. Yu, H. M. L. Davies and E. J. Sorensen, Rapid construction of a benzo-fused indoxamycin core enabled by site-selective C–H functionalizations, *Angew. Chem., Int. Ed.*, 2016, **55**, 8270–8274.
- 36 (a) H. M. L. Davies and J. Yang, Influence of a β -alkoxy substituent on the C–H activation chemistry of alkyl ethers, *Adv. Synth. Catal.*, 2003, **345**, 1133–1138; (b) C. Qin and H. M. L. Davies, Role of sterically demanding chiral dirhodium catalysts in site-selective C–H functionalization of activated primary C–H bonds, *J. Am. Chem. Soc.*, 2014, **136**, 9792–9796.
- 37 D. M. Guptill and H. M. L. Davies, 2,2,2-Trichloroethyl aryldiazoacetates as robust reagents for the enantioselective C–H functionalization of methyl ethers, *J. Am. Chem. Soc.*, 2014, **136**, 17718–17721.
- 38 Z. Ren, T. L. Sunderland, C. Tortoreto, T. Yang, J. F. Berry, D. G. Musaev and H. M. L. Davies, Comparison of reactivity and enantioselectivity between chiral bimetallic catalysts: bismuth-rhodium- and dirhodium-catalyzed carbene chemistry, *ACS Catal.*, 2018, **8**, 10676–10682.
- 39 S. Singha, M. Buchsteiner, G. Bistoni, R. Goddard and A. Fürstner, A new ligand design based on london dispersion empowers chiral bismuth-rhodium paddlewheel catalysts, *J. Am. Chem. Soc.*, 2021, **143**, 5666–5673.
- 40 M. Buchsteiner, S. Singha, J. Decaens and A. Fürstner, Chiral bismuth-rhodium paddlewheel complexes empowered by london dispersion: the C–H functionalization nexus, *Angew. Chem., Int. Ed.*, 2022, **61**, e202212546.
- 41 (a) J. P. Wagner and P. R. Schreiner, London dispersion in molecular chemistry—reconsidering steric effects, *Angew. Chem., Int. Ed.*, 2015, **54**, 12274–12296; (b) E. Solel,



- M. Ruth and P. R. Schreiner, London dispersion helps refine steric A-values: dispersion energy donor scales, *J. Am. Chem. Soc.*, 2021, **143**, 20837–20848; For reviews, see: (c) D. J. Liptrot and P. P. Power, London dispersion forces in sterically crowded inorganic and organometallic molecules, *Nat. Rev. Chem.*, 2017, **1**, 0004; (d) K. L. Mears and P. P. Power, Beyond steric crowding: dispersion energy donor effects in large hydrocarbon ligands, *Acc. Chem. Res.*, 2022, **55**, 1337–1348.
- 42 C.-J. Yoo, D. Rackl, W. Liu, C. B. Hoyt, B. Pimentel, R. P. Lively, H. M. L. Davies and C. W. Jones, An immobilized-dirhodium hollow-fiber flow reactor for scalable and sustainable C–H functionalization in continuous flow, *Angew. Chem., Int. Ed.*, 2018, **57**, 10923–10927.
- 43 J. M. Fraile, J. I. García, J. A. Mayoral and M. Roldán, Simple and efficient heterogeneous copper catalysts for enantioselective C–H carbene insertion, *Org. Lett.*, 2007, **9**, 731–733.
- 44 J. M. Fraile, P. López-Ram-de-Viu, J. A. Mayoral, M. Roldán and J. Santafé-Valero, Enantioselective C–H carbene insertions with homogeneous and immobilized copper complexes, *Org. Biomol. Chem.*, 2011, **9**, 6075–6081.
- 45 H. Suematsu and T. Katsuki, Iridium(III) catalyzed diastereo- and enantioselective C–H bond functionalization, *J. Am. Chem. Soc.*, 2009, **131**, 14218–14219.
- 46 J.-C. Wang, Z.-J. Xu, Z. Guo, Q.-H. Deng, C.-Y. Zhou, X.-L. Wan and C.-M. Che, Highly enantioselective intermolecular carbene insertion to C–H and Si–H bonds catalyzed by a chiral iridium(III) complex of a D₄-symmetric halterman porphyrin ligand, *Chem. Commun.*, 2012, **48**, 4299–4301.

