



Cite this: *Green Chem.*, 2024, **26**, 186

Organosolv biorefinery: resource-based process optimisation, pilot technology scale-up and economics

Giorgio Tofani, ^a Edita Jasiukaitytė-Grojzdek, ^a Miha Grilc ^{a,b} and Blaž Likozar ^{a,c,d,e}

This tutorial review aims to describe the status of the scaling up of organosolv treatment. It is a process where various lignocellulosic materials are fractionated, selective depolymerization mechanisms are catalyzed, and their main components (polysaccharides, lignin and extractives) can be extracted, separated and isolated using liquid organic solvents such as alcohols, ketones and proton-donating acid molecules. Organosolv fractionation can be applied to several renewable biomasses, allows the production of pure species systems to prepare valuable chemicals, polymers and biomaterial compositions with a related environmental impact, lower than that of classical industrial plants, and optimizes the resource carbon efficiency. However, the high energy consumption for the recovery after dissolution, input costs and feed-stock flexibility robustness are slowing down the piloting of commercial operations. As a critical indicator evaluation, a summary of reasons why engineering organosolv is still extremely interesting, together with an overview of the most important organosolv technologies, describing current equipment scale range economics, limitations and market research opportunities, is presented in detail. A variety of sources (wood, straw, bagasse, wastes...), media (water, methanol, ethanol, formates, acetates...) and products (biogas, bioethanol, (nano)cellulose, glucose, furans...) are comparatively benchmarked. Existing (model) validated, demonstrational or patented configurations are collected, listing strengths as well as challenges.

Received 30th August 2023,
Accepted 13th November 2023
DOI: 10.1039/d3gc03274d

rsc.li/greenchem

1. Introduction

Over the years, academic institutions, research centres and industries have been concentrating on finding green and sustainable technologies and raw materials to replace fossil resources to generate energy, chemicals, and materials (*i.e.*, plastics), reducing environmental pollution and developing a real and practicable circular economy. A valuable alternative is lignocellulosic biomass, mainly composed of wood and grass, and the resulting wastes generated by industrial production and end-life products, such as recycled paper and agricultural residues. These sources of lignocellulose are mainly used to produce energy, sugars and paper products.^{1–6}

Lignocellulosic biomasses are available in high quantities on the Earth (annual output of around 170 billion

tons per year (ref. 7)), and their use shows a low carbon footprint.^{8,9} However, lignocellulose is not beneficial only to produce commodities such as sugars. The reason is correlated with the heterogeneous composition of such a kind of biomass. It contains lignin (a crosslinked phenolic polymer), cellulose (a linear polymer composed of glucose), hemicellulose (a branched heteropolymer composed of different sugar units) and extractives (a heterogeneous mixture of various compounds such as fatty acids and rosin). These biopolymers and chemicals can be recovered and used to prepare a wide range of biomaterials and high-value chemicals.^{10–15}

The first and primary step to separate the different components of lignocellulose is the pulping process to break the biomass's rigid structure. The most common methods are the ones used already in the paper industry, called kraft and sulphite processes.¹⁶ However, these treatments were designed to obtain cellulose fibres for papermaking, ignoring the loss and degradation of lignin and hemicelluloses. Moreover, lignin can be removed by acid and enzymatic treatments during the production of sugars.² Lignin and hemicelluloses can be recovered from the resulting waste streams, but their quality is low due to the high depolymerisation rate and contamination by, for example, sulphur and the high content of salts. Therefore,

^aDepartment of Catalysis and Chemical Reaction Engineering, National Institute of Chemistry, Hajdrihova 19, SI-1001 Ljubljana, Slovenia. E-mail: Giorgio.Tofani@ki.si, Blaž.Likozar@ki.si

^bUniversity of Nova Gorica, Vipavska 13, SI-5000 Nova Gorica, Slovenia

^cPulp and Paper Institute, Bogišičeva 8, 1000 Ljubljana, Slovenia

^dFaculty of Polymer Technology, Ozare 19, SI-2380 Slovenj Gradec, Slovenia

^eFaculty of Chemistry and Chemical Technology, University of Ljubljana, Večna pot 113, SI-1000 Ljubljana, Slovenia



the development of biorefineries for the appropriate processing of lignocellulosic raw materials is crucial to achieve a circular economy. They will offer a more eco-sustainable solution with a fractionation process designed with the target of extraction and valorisation of all the components of lignocellulose, looking to have a “zero-waste” approach. All the streams generated must be considered a valuable source of chemicals, energy and biomaterials.

In this manuscript, the focus will be on the organosolv process. It is a fractionation treatment where organic solvents such as ethanol, acetone, formic acid and acetic acid are combined or not with water and catalysts (*i.e.*, sulfuric acid) at temperatures above 100 °C to separate lignin, cellulose and hemicellulose.¹⁷ Afterwards, the biopolymers are recovered by filtration, precipitation and evaporation processes. In particular, it was found that the organosolv processes allow the extraction of lignin having higher purity than lignin obtained using other pulping processes.¹⁸ The reasons why the organosolv process is highly interesting are described in the next section.

Before continuing in this description of the organosolv process, it is essential to underline that the fractionation processes where ionic liquids and deep eutectic mixtures are used as solvents were not considered in order to separate “classical” organic solvents from “designer” solvents as described in the literature.^{19,20}

2. Why is organosolv a valuable process?

The possibility to select the organic solvents, typically available in the academic and industrial sectors, and tune the reaction conditions, such as time, temperature and the ratio of organic solvent/water, allows using the organosolv process on different types of lignocellulosic biomasses such as wood (e.g. bark, sawdust and logs), grass (*i.e.* *Miscanthus giganteus*), agricultural residues (e.g. rice husk and corn stover) and waste paper (e.g. cardboard).^{17,19–21} A list of lignocellulosic biomasses treated using organosolv fractionation is reported in Table 1. The main advantage of this methodology is that all the main components from lignocellulose, extractives, hemicelluloses, cellulose and lignin can be extracted and valorised to produce chemicals and biomaterials. In particular, highly pure lignin can be isolated. The classical methods (kraft and sulphite processes) strongly modify the chemical structure of the lignin by condensation reactions and insertion of sulphur.¹⁶ Soda and hydrolysis processes show higher contents of ashes and sugars in the isolated lignin, reducing the purity.¹⁸ Consequently, the organosolv process can be used to develop biorefineries using it as a fractionation stage. A simplified scheme of the organosolv process applied in a biorefinery is shown in Fig. 1.

Regarding the components that can be extracted and used to prepare high-value chemicals and biomaterials, this manuscript focuses on the main four: extractives, hemicelluloses, cellulose and lignin.

2.1. Extractives

Extractives are a mixture of various chemicals (phenolic compounds, fats, waxes, terpenes and terpenoids), which, by definition, are soluble in organic solvents. The extractives are the less developed family of chemicals studied after organosolv treatment because they are generally separated by a pre-treatment.²² However, two recent publications studied the recovery of extractives from spent coffee grounds and exhausted olive pomace, using the organosolv process by the application of a solvent mixture composed of methanol/hexane or ethanol/water in the presence of sulfuric acid, which found use as the catalyst. Afterwards, the extractives were converted to fatty acids (fatty acids methyl esters and omega-3 fatty acids).^{23,24}

2.2. Hemicelluloses

More studies were done on the valorisation of hemicelluloses.

Hemicellulose is a branched polysaccharide mainly composed of xylose, arabinose, glucose, mannose, galactose, and rhamnose. This polysaccharide can be extracted from different lignocellulosic biomasses (*i.e.* wood and straw) using various organosolv methods; the most described process consists of using an ethanol/water solution in the presence or not of acid and alkali catalysts such as sulfuric acid and sodium hydroxide. The extracted hemicelluloses were further modified using biological and chemical methods in order to obtain iso-butanol,²⁵ as a component for biofilms,²⁶ ethyl glycosides²⁷ and furfural for resin applications.²⁸

2.3. Cellulose

The organosolv fractionation also allows cellulose recovery, a linear polysaccharide composed of glucose units. Cellulose can be extracted from different lignocellulosic biomasses, such as wood, straw and cardboard, by organosolv methods. Various organosolv processes were studied to recover cellulose, such as aqueous solutions containing organic acids (formic acid and acetic acid), alcohols (ethanol, methanol and glycerol) and alternative solvents (gamma-valerolactone). Acid or alkali catalysts are also added to enhance the fractionation efficiency. Currently, the main application of organosolv cellulose consists in its fermentation to produce commodities such as sugars and biofuels.^{29,30} However, high-value chemicals and biomaterials can also be obtained. The main studies focus on generating cellulose nanofibrils (CNF),³¹ nanocellulose,³² cellulose nanocrystals (CNCs),^{33,34} butyl glucosides,³⁵ carboxymethylcellulose³⁶ and dissolving pulp.³⁷

2.4. Lignin

Lignin is the most studied component extracted from lignocellulosic biomass using organosolv processes. It is a highly branched and heterogeneous macromolecule composed of phenyl propane units. Lignin can be extracted from cardboard, grass, wood, grass, cornstalk, stover, and other agricultural residues using different organosolv fractionations. These methods include using solutions composed of organic acids (formic acid and acetic acid), alcohols (ethanol, methanol and butanol) and ketones such as acetone. Adding acid (both



Table 1 Lignocellulosic biomasses and applications of extractives, hemicelluloses, cellulose and lignin

Lignocellulosic source	Organosolv solvent	Extractive applications	Hemicellulose applications	Cellulose applications	Lignin applications	Ref. e
Corn stover	Gama-butyrolactone/water aluminium sulfate octadecahydrate	—	—	—	—	10
Old corrugated cardboard	Formic acid/water	—	—	Dissolving pulp	—	21
Bark of Norway spruce	Ethanol/water, sulfuric acid	—	—	—	—	22
Spent coffee grounds	Methanol/hexane, sulfuric acid	Fatty acid methyl esters	Biogas	Biogas	—	23
Exhausted olive pomace	Ethanol/water, sulfuric acid	Omega-3 fatty acids	—	—	—	24
Beechwood	Ethanol/water	—	Isobutanol	—	—	25
Wheat straw	Ethanol/water, sodium hydroxide	—	Biofilm	Nanocellulose biofilm	—	26
Sitka spruce wood	Ethanol/water, sulfuric acid	—	Ethyl glycosides	Glucose	—	27
Debarked beech wood	Ethanol/water, sulfuric acid	—	Furfural	—	—	28
Sugarcane bagasse	Ethanol/water, sulfuric acid	—	—	Glucose	—	29
Sugarcane bagasse	Glycerol/water, sulfuric acid	—	—	Bioethanol	—	30
Hardwood	1,4-Butylene glycol/water, 1-butyl-3-methylimidazolium hydrogen sulfate as catalyst	—	—	Cellulose Nanofibrils biofilm	—	31
Kenaf fibres	Acetic acid/water, hydrogen peroxide	—	—	Nanocellulose	—	32
Bark-free birch woodchips	Ethanol/water	—	—	Nanocellulose	—	33
Eucalyptus hardwood	Gama-valerolactone/water or ethanol/water with sulfuric acid	—	—	Cellulose nanocrystals	—	34
Rice Straw	Ethanol/water, organic acid	—	—	Butyl Glucosides	—	35
Wood chips	Methanol/water	—	—	Carboxymethylcellulose	—	36
Wood chips	Ethanol/water, sulfuric acid	—	—	Dissolving pulp	—	37
Aspen wood chips	Ethanol/water, hydrochloric acid	—	—	—	Aerogels	38
Beechwood	Lignin, Fraunhofer CBP ^a	—	—	—	Coating material	39
Beechwood, Japanese knotweed	Ethanol/water, sulfuric acid	—	—	—	Barrier coating material	40
Beechwood	Lignin, Fraunhofer CBP ^a	—	—	—	Tissue engineering	41
Corn stover	Ethanol/water, sulfuric acid or formic acid or sodium hydroxide	—	Sugars	Sugars	Nanoparticles	42
Wood chips	Ethanol/water	—	—	—	Flotation collector	43
Wheat straw, spruce wood, beech wood	Ethanol/water	—	—	—	Nanoparticles	44
Beechwood	Lignin, Fraunhofer CBP ^a	—	—	—	Adhesive	45
Cornstalk	Formic acid/acetic acid/water	—	—	—	Adhesive	46
Beechwood chips	Ethanol/water, sulfuric acid	—	—	—	Adhesive	47
Beechwood	Lignin, Fraunhofer CBP ^a	—	—	—	Composite for 3D printing	48
Oil palm empty fruit bunch	Formic acid/water	—	—	—	Composite for 3D printing	49
Southern yellow pine	Ethanol/water, sulfuric acid	—	—	—	Stereolithography	50
Hybrid poplar chips	Butanol/water, acetic acid	—	—	—	Self-healing polymer	51
Bamboo	Acetic acid/water	—	—	—	Self-healing polymer	52
Miscanthus X giganteus	Ethanol/water	—	—	—	Antioxidant	53
n.d.	Lignin, Chemical point UG ^b	—	—	—	Oxidant inhibitor	54
Corncob	Ethanol/water	—	—	—	Antioxidant	55
n.d.	Lignin, South China University of Technology ^b	—	—	—	UV-absorber	56
n.d.	Lignin, Shanfeng Co. Ltd ^b	—	—	—	Metal biosorbent	57
n.d.	Lignin, Shanfeng Co. Ltd ^b	—	—	—	Metal biosorbent	58



Table 1 (Contd.)

Lignocellulosic source	Organosolv solvent	Extractive applications	Hemicellulose applications	Cellulose applications	Lignin applications	Ref. e
Aleppo pine, <i>Eucalyptus globulus</i>	Ethanol/water, sulfuric acid	—	—	—	Stabilisers for cellulose nitrate	59
Coconut shells	Acetone/water, inorganic acids	—	—	—	Flame retardant resin	60
Exhausted olive pomace	Ethanol/water, sulfuric acid	—	—	—	Rigid polyurethane foam	61
Spruce wood	Ethanol/water, sulfuric acid	—	—	—	Antimicrobial	62
Banana peels	Acetic acid/water, hydrochloric acid	—	—	—	Antioxidant, Antimicrobial	63
Poplar wood	Methanol/dioxane	—	—	—	Biofilm	64

^a It is not specified, but Fraunhofer CBP technology is based on ethanol/water organosolv process. ^b No other information is provided.

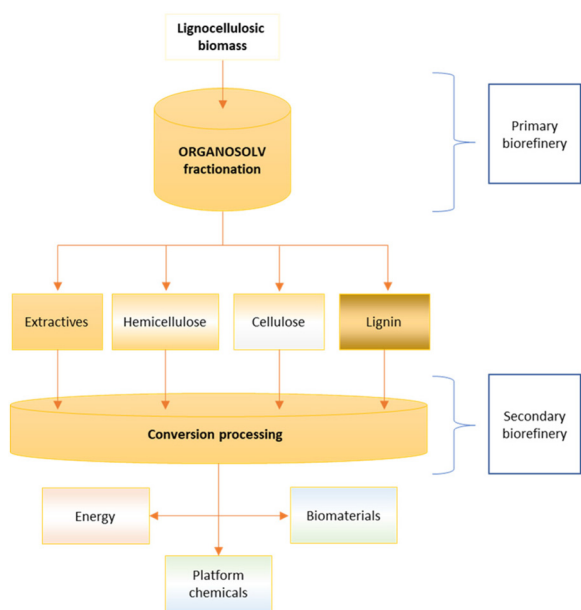


Fig. 1 Organosolv fractionation in biorefinery.

organic and inorganic) or alkali catalysts is also considered to boost fractionation yields. The interest in organosolv lignin comes from its superior purity over the other technical types.¹⁸ For this reason, organosolv lignin is under study for the preparation of added-value materials such as aerogels,³⁸ coating materials,^{39,40} tissue engineering,⁴¹ nanoparticles,^{42–44} adhesives,^{45–47} bio-composites for 3D-printing,^{48–50} recyclable and self-healing polymers,^{51,52} antioxidant agents,^{53–55} UV-absorber agents,⁵⁶ metal absorbers for wastewater treatment,^{57,58} stabilisers of cellulose nitrate,⁵⁹ flame retardant resins,⁶⁰ polyurethane foams,⁶¹ antimicrobial agents^{62,63} and bio-films.⁶⁴

3. Organosolv processes over the years

Due to their great potential, several organosolv processes have been developed over the years, and novel solvents are under

study. They can be classified into four categories based on the type of solvents used: alcohol, ketone, organic acid, and hybrid processes. Below, the main organosolv processes are briefly described. The processes are also reported in Table 2.

The Alcell treatment is one of the oldest organosolv processes developed.⁶⁵ In this case, aqueous ethanol (around 50%) is used as the solvent operating at about 180–200 °C and a pressure of 29–31 bars.⁶⁶ The pH is around 4 without adding acid or alkali compounds due to the formation of acetic acid during biomass fractionation. Currently, operational plants are not reported. A scheme of the Alcell process is reported in Fig. 2.

The organocell method is a two-stage process where aqueous methanol (around 50%) is used as the solvent. In the first stage, the “acid stage”, the biomass is treated in the solvent having pH = 4–6, at around 200 °C and 40 bars. In the second stage, called the “alkaline stage”, sodium hydroxide with fresh solvent is added, and the temperature is kept at around 170° with a pH between 8 and 12.^{67,68} Currently, operational plants are not reported. A scheme of the organocell process is reported in Fig. 3.⁶⁹

The lignol process is an ethanol–water treatment derived from the Alcell method. The main difference is the addition of an inorganic acid (e.g. sulfuric acid) to keep the pH between 2 and 3.^{70,71} Currently, a pilot plant is operational. A description is reported in the next section. A scheme of the lignol process is shown in Fig. 4.

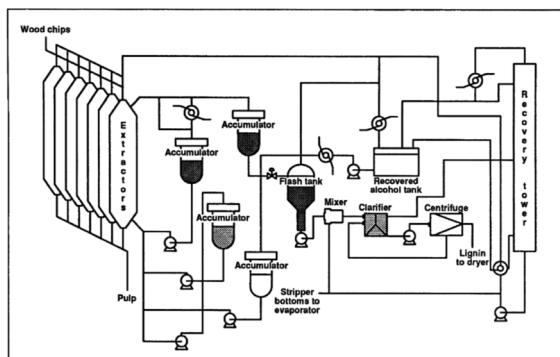
The alkali–sulphite–anthraquinone–methanol (ASAM) process is derived from alkaline sulphite pulping where anthraquinone is used as the delignification catalyst but methanol (around 30%) is applied as the co-solvent together with water. The working temperature is about 170–180 °C, and the pH is above 13.^{72,73} A variation using ethanol instead of methanol was also studied.⁷⁴ Currently, operational plants are not reported. A scheme of the ASAM process is reported in Fig. 5.

The Fraunhofer Centre developed an alcohol organosolv process using aqueous ethanol (around 90%) at 200 °C and 40 bars. This treatment can be considered an Alcell-derived process.^{75,76} Currently, a pilot plant is operational. A description is reported in the next section. A scheme of the process is shown in Fig. 6.

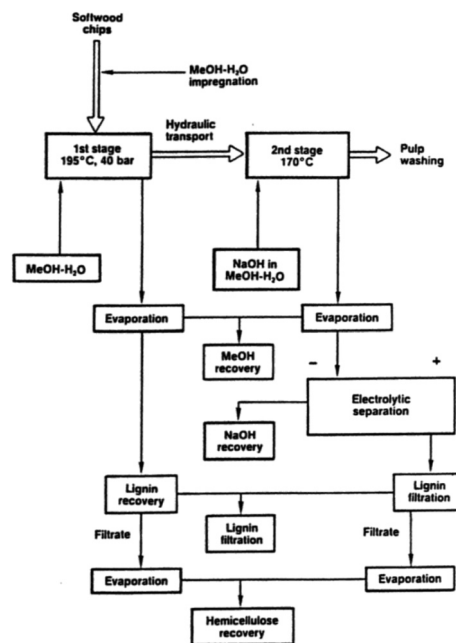


Table 2 Summary table of organosolv processes

Name	Class	Solvent	Conditions	Ref.
Alcell	Alcohol organosolv	Aqueous ethanol	180–200 °C, 29–31 bar, pH 4	65 and 66
Organocell	Alcohol organosolv	Aqueous methanol	(1) pH = 4–6, 200 °C, 40 bar (2) pH = 8–12 170 °C	67–69
Lignol	Alcohol organosolv	Aqueous ethanol	Alcell-like conditions with Sulfuric acid pH 2–3	70 and 71
ASAM	Alcohol organosolv	Aqueous methanol or ethanol (>30%)	pH above 13, 170–180 °C, anthraquinone as catalysts, sulphite as delignification agent	72–74
Fraunhofer Centre	Alcohol organosolv	Aqueous ethanol (90%)	Alcell-like conditions, 200 °C, 40 bar	75 and 76
Glycell	Alcohol organosolv	Glycerol	Sulfuric acid as catalyst, 130–160 °C, 2–5 bar	77 and 78
Fabiola	Ketone organosolv	Aqueous acetone	Sulfuric acid as catalyst, 140 °C, 15 bar	79–81
SEW or AVAP®	Alcohol organosolv	Aqueous ethanol	Sulphur dioxide at 130–160 °C	82–84
Vertoro B.V (Goldilocks®)	Alcohol organosolv	Methanol	Sulfuric acid as catalyst, 160–200 °C, 15 bar	85–87
AST	Alcohol organosolv	Butanol	Sulfuric acid as catalyst, 180 °C	51 and 88
Acetosolv	Organic acid organosolv	Acetic acid 85%	Sulfuric acid as catalyst, 200 °C, 20 bar	90–92
Acetocell	Organic acid organosolv	Acetic acid 85%	200 °C, 20 bar	90–92
Formacell	Organic acid organosolv	Acetic acid 85%, Formic acid 10%	Acetosolv-like conditions	93 and 94
Milox	Organic acid organosolv	Aqueous formic acid	(1) 120 °C (2) addition of performic acid	95 and 96
Formico	Organic acid organosolv	Aqueous formic acid (>40%)	130–170 °C	97 and 98
CIMV	Organic acid organosolv	Acetic acid/formic acid/water mixture (30 : 50 : 20)	110 °C	99–101
LignoFibre	Organic acid organosolv	Acetic acid (80%)	Phosphinic acid (3.5%) as catalyst, 150 °C	102 and 103
Bloom	Hybrid organosolv	Dioxane	Chloric acid as catalyst and formaldehyde as stabiliser, 80–100 °C	104–106

**Fig. 2** The Alcell process (reproduced from ref. 65 with permission from *Tappi J.*, copyright 1991).

The Australian company Leaf Resources Ltd has ownership of the Glycell™ process.^{77,78} It consists of an organosolv fractionation composed of glycerol as a solvent in the presence of sulfuric acid as a catalyst. The operating temperature is around 130–160 °C and pressure is 2–5 bars. Currently, a pilot-scale plant is operational. A description is reported in the next section.

**Fig. 3** The organocell process (reproduced from ref. 69 with permission from *Tappi J.*, copyright 1989).

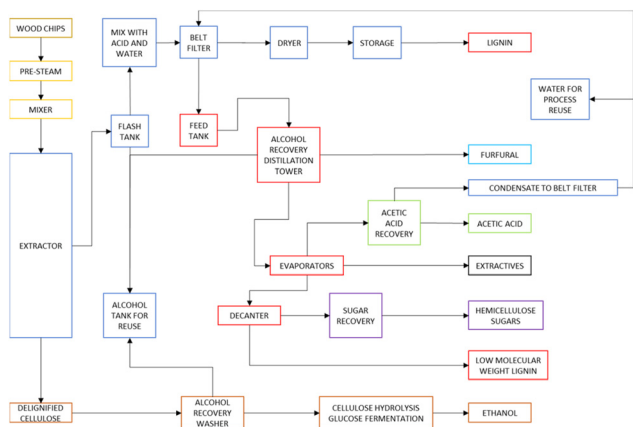


Fig. 4 The Lignol process (image redrawn and modified from ref. 70).

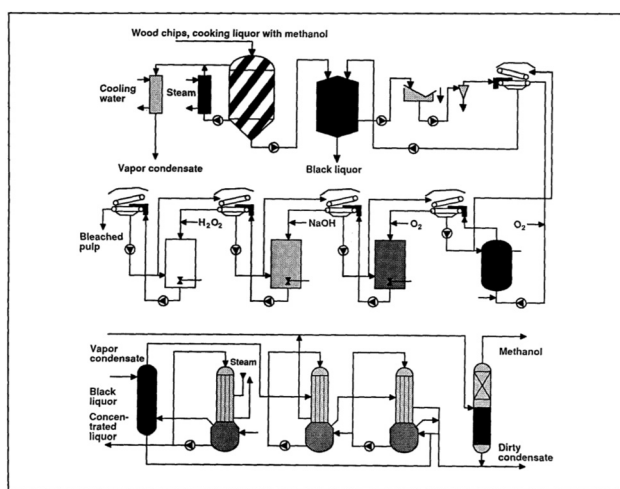


Fig. 5 The ASAM process (reproduced from ref. 72 with permission from Tappi J., copyright 1991).

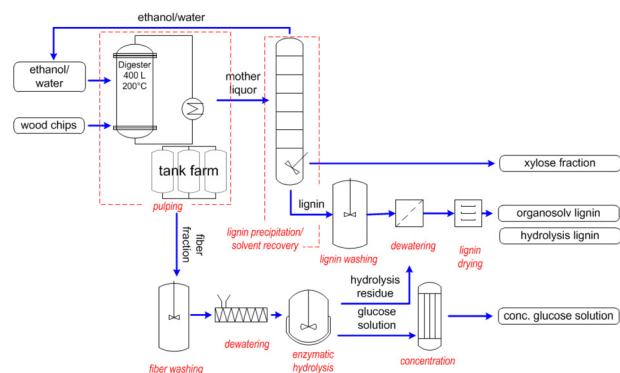


Fig. 6 Example of the Fraunhofer Centre organosolv process (reproduced with permission and courtesy from Fraunhofer CBP, copyright: © Fraunhofer CBP).

The Netherlands Organization for Applied Scientific Research (TNO) developed an organosolv process called Fabiola. In this treatment, aqueous acetone (around 50%) is

used as a solvent, in the presence of sulfuric acid as the catalyst, at 140 °C and under 15 bars.^{79–81} Currently, operational plants are not reported, but studies for the scale-up are ongoing. A scheme of the Fabiola process is reported in Fig. 7.

The SO₂-Ethanol-Water (SEW) or American Value-Added Pulping (AVAP®) is an ethanol-based organosolv process operating in the presence of sulphur dioxide at 130–160 °C.^{82–84} Currently, operational plants are not reported. The main limitation is the use of toxic gas. A scheme of the SEW process is reported in Fig. 8.

The Vertoro B.V. company developed a patented process to obtain a crude liquid lignin oil useful as a chemical platform (Goldilocks®). The lignocellulosic biomass is processed using methanol as the solvent and sulfuric acid as a catalyst at 160–200 °C and under around 15 bars.^{85,86} Currently, operational plants are not reported, but studies for the scale-up are ongoing. A scheme of the process is reported in Fig. 9.⁸⁷

The American Science and Technology Corporation (AST) is currently using butanol as a solvent in the presence of sulfuric acid as a catalyst. The optimal temperature is 180 °C.^{51,88} Now, a semi-continuous plant is operational. A scheme of the AST process is reported in Fig. 10. A homogeneous solution of butanol and water in a 1 : 1 ratio is formed due to the operative temperature being above 120 °C.^{88,89} At the end of the fractionation, the solvent is transferred to a tank where a split between the organic layer and the aqueous layer is possible, allowing the separation and recycling of the organic phase.

Acetosolv and Acetocell processes are two organosolv treatments that use acetic acid (85%) as the solvent operating at

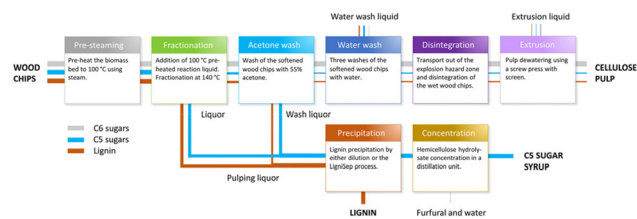


Fig. 7 The Fabiola process (reproduced from ref. 79 with permission from the authors. Published by American Chemical Society, copyright 2022).

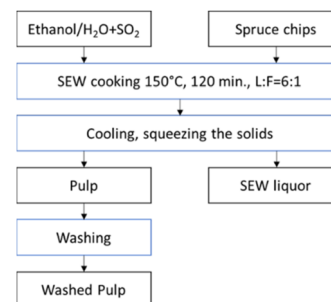


Fig. 8 The SEW process (image redrawn and modified from ref. 83).



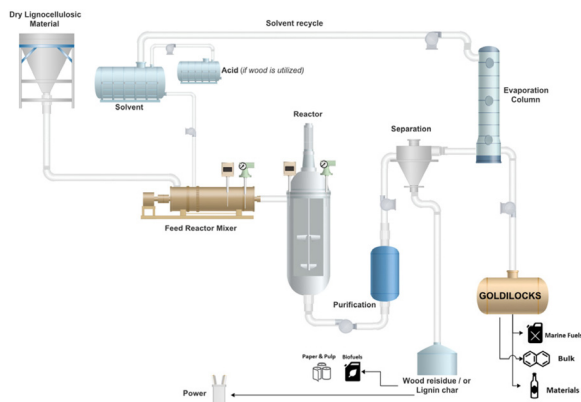


Fig. 9 The Vertoro B.V. process (reproduced from ref. 87 with permission from Vertoro B.V., copyright: 2021).

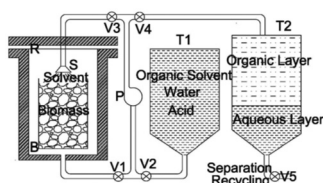


Fig. 10 The AST process (reprinted with permission from ref. 51. Copyright 2019 American Chemical Society.).

around 200 °C and under 20 bars.^{90,91} The difference is that an acid catalyst (e.g. sulfuric acid) is present in the Acetosolv process.⁹² Currently, operational plants are not reported.

The Formacell treatment is a derived Acetosolv process where a mixture of formic acid and acetic acid is used instead of acetic acid alone. Typically the solvent is 85% acetic acid, 10% formic acid and 5% water.^{93,94} Currently, operational plants have yet to be reported.

Chempolis Oy developed a process called Milox, where formic acid is used as a solvent operating at around 120 °C. In the second step, performic acid is added to enhance the delignification.^{95,96} Currently, operational plants are not reported.

Chempolis Oy also developed a second organosolv process called Formico. In this technology, formic acid is the main component in the biosolvent and the main delignification agent having a concentration of at least 40% with an operative temperature of 130–170 °C.^{97,98} Currently, a pilot plant is operational, and studies for a further scale-up are ongoing. A description is reported in the next section. A scheme of the possible production concept using the Formico process is reported in Fig. 11. Together with sulphur-free lignin and ethanol, Formico allows the extraction and isolation of sugar-based products. Alternatively, cellulose can be used for paper-making or textile applications.

The Compagnie Industrielle de la Matière Végétale (CIMV) developed an organosolv process based on an acetic acid/formic acid/water mixture (typically 30:50:20) working at around 110 °C.^{99–101} Currently, a pilot plant is operational. A

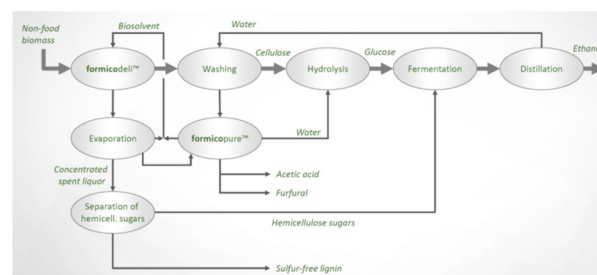


Fig. 11 The Formico process (reproduced with permission and courtesy from Chempolis Oy, copyright: 2022).

description is reported in the next section. A scheme of the process is reported in Fig. 12.

The Technical Research Centre of Finland Ltd (VTT) developed an organosolv process called LignoFibre. This process consists of using acetic acid (80%) as a solvent in combination with phosphinic acid (3.5%), working at 150 °C.^{102,103} Currently, operational plants are not reported.

The Swiss start-up Bloom Biorenewables, created in 2019 as a spin-off from the École Polytechnique Fédérale de Lausanne, is working on the scale-up of an organosolv process. The biomass is treated using dioxane as a solvent, chloric acid as a catalyst and formaldehyde as a stabiliser to control the lignin depolymerisation. The typical temperature is around 80–100 °C.^{104–106} The main novelty of the reaction compared to the organosolv process described before is the use of formaldehyde as a protective agent of lignin, reducing the risk of condensation and modification reactions. Combined with low temperatures and elevated lignin solubility in dioxane, this process allows for the production of high-quality lignin. Currently, the process is developed at a laboratory scale (10 L).

The processes show similar operative conditions. Therefore, their scaling up, in section 4, is based on chemical and economic evaluations of the companies which are owners of the patents.

It is possible to provide an overview to differentiate the processes on the lignin structure depending on the process parameters. Organic and inorganic acids enhance the removal of lignin, breaking the lignin-carbohydrate bonds, but reduce the β -O-4 bonds. An increase in temperature (above 170–180°)

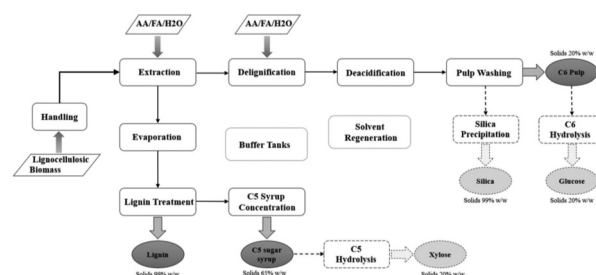


Fig. 12 The CIMV process (reproduced from ref. 100 with permission from the Authors Published by Frontiers, copyright: 2020).



decreases the molecular weight and increases the phenol content. The solvents modify the functional groups of lignin. For example, the lignin extracted with an organic acid presents a higher content of carboxylic groups. The lignin extracted using alcohol shows a higher content of hydroxyl groups.¹⁰⁷

4. Scale-up

Despite the various studies and the high interest in the organosolv process, its commercial scale-up still needs to be achieved. The reason is correlated to the limitations described in section 5 – Challenges. Currently, four pilot plants are operational, three in Europe and one in North America.¹⁰⁸ The current pilot-scale plants and future scale-up are summarised in Table 3.

A plant based on Lignol technology is operational for generating ethanol and lignin (around 1.000 t per year) from softwood and hardwood.¹⁰⁸ The supplier is Suzano company, born by merging Suzano Pulp and Paper and Fibria Innovation Inc. (owner of Lignol technology).¹⁷

The Fraunhofer Centre in Germany has a pilot plant based on its technology where ethanol, lignin (around 500 t per year) and xylose are produced starting from hardwood as the raw material.¹⁰⁸

The Leaf Resources Ltd has a pilot scale plant based on the Glycell™ technology.⁷⁷ Currently, the plant produces around 8000 t per year of wood resin and wood turpentine starting from pine. In 2022, it started rebuilding and upgrading the plant to reach a production of 16 000 t per year of wood products.¹⁰⁹

The CIMV has a plant in France based on their technology for producing lignin (around 1.000 t per year), cellulose, C5 sugars and silica. The biomasses used as starting material are wheat straw, wood and bagasse.¹⁰⁸

Chempolys Oy, in collaboration with Fortum Oyj, developed a pilot plant based on Formico technology for producing ethanol, cellulose pulp, lignin (around 1.000 t per year), xylose and other biochemicals from different biomasses such as wood, straw, grass and bagasse.¹⁰⁸

Together with these pilot plants, AST has an operational semi-continuous plant, with a reactor of around 7600 litres, for generating cellulose and lignin (around 26 t per year).¹¹⁰ However, it is used for scientific purposes.

Simultaneously, projects are ongoing to develop new organosolv methods and the process scale-up. The Fabiola process was studied during the European project UnRavel (no. 792004), which ended in May 2022. The process passed from a laboratory scale to a reactor of 460 litres, and the starting material was composed of wood chips.⁷⁹

The European project Fraction (no. 101023202) involves developing a scalable organosolv process based on gamma-valerolactone (GVL). This project started in 2021 and will end in 2024. Currently, they are testing different types of biomasses, including agricultural residues and paper and pulp industry residues.¹¹¹

The company Bloom Biorenewables is working on the scale-up of its patented process. Currently, they are studying to pass from the laboratory scale of a 10 L reactor to 630 L for a pilot plant. The most studied biomass for this process is wood.¹¹²

In 2022, Vertoro B.V. started a collaboration with the Swedish company Sekab to construct a demo plant for the scale-up of Goldilocks® technology using different biomasses such as lignin, plants and residues from the paper industry.¹¹³

In conclusion, Fortum Oyj and Chempolis Oy are working on the development of a European industrial plant with a capacity of organosolv lignin production of 50.000 t per year using Formico technology. The raw materials would be 300.000 t per year of straw. The plant is expected to be operational in 2027.¹¹⁴

Table 3 Scale-up of organosolv processes and current research

Name	Organosolv class	Current lignin scale	Future lignin scale	Starting biomass	Ref.
Lignol	Alcohol	1.000 t per year	—	Wood	108
Fraunhofer	Alcohol	500 t per year	—	Hardwood	108
Glycell	Alcohol	8.000 t per year ^a	16.000 t per year ^a	Softwood	109
CIMV	Organic acid	1.000 t per year	—	Wheat straw, wood and bagasse	108
Formico	Organic acid	1.000 t per year	50.000 t per year (expected in 2027)	Wood, straw, grass and bagasse	108 and 114
AST	Alcohol	26 t per year	—	Hardwood, softwood, and agricultural wastes	110
Fabiola	Ketone	460 L reactor	—	Wood chips	79
Fraction project	Hybrid	—	Laboratory Scale (project started in 2021)	Agricultural residues and paper and pulp industry residues	111
Bloom Biorenewables	Hybrid	—	630 L reactor (Start-up started in 2019)	Mainly wood	112
Vertoro B.V.	Alcohol	—	Demo-plant (Project started in 2022)	Lignin, plants, and residues from the paper industry	113

^aWood products.



5. Challenges

The first publications about the organosolv process are from the second half of 1980, but no commercial or industrial plants are currently operational. Over the years, several techno-economic and LCA analyses were carried out on the organosolv process to detect the critical issues from the economic and environmental points of view. Most of the techno-economic analyses show that the scaling up of the organosolv process is difficult due to the high costs related to the purchase of chemicals and the energy consumption caused by heating and solvent recycling. However, the life-cycle assessment (LCA) studies showed that the organosolv process is more environmentally friendly than classical pulping treatments.

In order to summarise the types of organosolv processes studied, we tried to classify such kinds of fractionations to the closer known organosolv classes already described above. In Table 4, the techno-economic analysis and LCA studies are reported.

In 2016, Nitzsche *et al.* simulated, using Aspen Plus® software, the organosolv process (Lignol-like) of having 400 000 t per year beech wood chips as feedstock. The target products were polymer-grade ethylene, organosolv lignin and fuel. The main conclusion is that the heat-integrated biorefinery concept is not profitable. Therefore, only highly valuable products sold at high prices can open to a cost-effective process.¹¹⁵

Budzinski and Nitzsche simulated four organosolv biorefineries (Lignol-like) to compare their economic and environmental aspects. The feedstock is 400 000 t per year of beech wood. The products are polymer-grade ethylene, organosolv lignin, the fuel hydrolysis lignin, biomethane, liquid “food-grade” carbon dioxide and anhydrous ethanol. Aspen Plus® v8.6 software was used for the simulations. All four biorefineries showed a lower environmental impact when compared with reference systems (currently available fossil-based technologies to provide the target products) used for comparisons. However, the economic profitability is strongly influenced by the costs of feedstocks and the price of the products.¹¹⁶

In 2017, Zhao *et al.* wrote a review of different organosolv fractionation pre-treatments for enzymatic saccharification of cellulose where solvents such as ethanol, acetone and acetic acid were applied. The authors say this process is still not competitive compared to conventional pre-treatments due to the cost of organic solvents and their recovery. The reduction of energy consumption for solvent recovery and the development of more high-value products are two crucial points to make the organosolv process profitable.¹¹⁷

In 2018, Moncada *et al.* studied the techno-economic and environmental aspects of C6-sugar production from spruce and corn, comparing organosolv (Lignol-like) and wet-milling technologies considering a plant capacity of around 1 000 000 t of dry wood (feedstock) per year. Based on the results, the organosolv process looks more environmentally friendly and economically feasible but with higher investment costs than wet milling technology. Moreover, the authors report that the

economics of the organosolv process is highly sensitive to the yields of lignin and sugars.¹¹⁸

Gurgel da Silva *et al.* made a techno-economic analysis of an organosolv process (Lignol-like) to obtain technical lignin. It was observed that a high amount of energy is required to disrupt the lignocellulosic structure (1/3rd of the total production costs). Aspen Plus v8.0 simulated a process of 88.500 kg h⁻¹ dry biomass considering wood as the feedstock. The authors conclude that to make the process economically sustainable, it is necessary to improve the energy-saving mechanisms and enhance the recovery of the products.¹¹⁹

Santos *et al.* present a techno-economic analysis and an environmental assessment of the production of bio jet fuel, acetic acid, furfural and succinic acid using a sugarcane-based biorefinery. Eight biomass pre-treatment technologies were considered, *i.e.* dilute acid, dilute acid + alkaline treatment, steam explosion, steam explosion + alkaline treatment, organosolv (Lignol-like), alkaline wet oxidation, liquid hot water and liquid hot water + alkaline treatment. Organosolv was one of the processes able to obtain the highest yield of fuel and reduce greenhouse gas (GHG) emissions, but, at the same time, required the highest operational costs (solvent purchase and recycling).¹²⁰

Bello *et al.* studied the LCA of different lignocellulosic biorefinery scenarios for an integrated valorisation of residual beech wood chips using an organosolv process (Lignol-like). The plant capacity considered was 83.3 t h⁻¹ of dry wood. The authors conclude that the optimisation of technologies to improve energy saving and the production of high-value products is crucial for the feasibility of the industrial process. However, more studies are necessary to evaluate the development of an integrated biorefinery.¹²¹

Patel *et al.* studied the production of bioplastics from lignocellulosic biomasses using steam explosion and organosolv (Lignol-like and CIMV-like) processes. The target products were C6–C5 sugars and lignin. Only organosolv provides high purity lignin. For this study, the calculation considered the production of 1 kg of bioplastic as a functional unit. In this case, the profitability of the organosolv process is sensitive to the final price of the products and the necessity of energy integration. The CIMV process shows an 8% lower GHG impact and higher yield of C5-sugars.¹²²

In 2019, Nieder-Heitmann *et al.* simulated and compared, using Aspen Plus® software, the production of succinic acid and electricity from biomasses using different processes: dilute acid, alkaline, organosolv (Lignol-like), ammonia fibre expansion, steam explosion, and wet oxidation. In the organosolv process, the feedstock was (23 400 t h⁻¹ bagasse and trash). However, the organosolv process was not economically profitable together with the wet oxidation treatment due to limited energy efficiency.¹²³

Mesfun *et al.* assessed a techno-economic hybrid process (organosolv–steam explosion) using wood (hardwood and softwood) as biomass. The model was developed with the target production of 50.000 t per year of lignin. The organosolv is a Lignol-like treatment. However, it is an extremely energy-inten-



Table 4 Economic and environmental assessments, scale and limitations

Type of assessment	Organosolv process	Estimated scale	Limitations	Environmental advantages over other processes	Ref.
Economic	Lignol-like	400 000 t per year Beechwood chips	Heat integrated biorefinery	—	115
Economic and Environmental	Lignol-like	400 000 t per year Beechwood chips	Influence of feedstocks price	Low environmental impact	116
Economic ^a	Alcohol, ketone and organic acid organosolv	—	Price of organic solvents, energy consumption	—	117
Economic and Environmental	Lignol-like	1 000 000 t per year dry wood	High investment costs, yields of products	Low environmental impact	118
Economic	Lignol-like	88 500 kg h ⁻¹ wood	Energy consumption and products yields	—	119
Economic and Environmental	Lignol-like	208 900 ton per year bio-jet (product)	High operational costs (solvent purchase and recycling)	Organosolv reduces GHG emissions	120
Environmental	Lignol-like	83.3 t h ⁻¹ of dry wood	Energy consumption and price of products	—	121
Environmental	Lignol-like and CIMV-like	1 kg of bioplastic as a functional unit	Final product price, energy consumption	Reduction of GHG	122
Economic	Lignol-like	23 400 t h ⁻¹ bagasse and trash	Low energy efficiency	—	123
Economic	Lignol-like	Softwood and hardwood for target production of 50 000 tons of dry lignin per year	Energy consumption, the value of the products	—	124
Economic and environmental	Lignol-like	97 000 kg h ⁻¹ for 7920 h of corn stover	High costs in utilities due to recycling processes and CO ₂ emissions, heat integration not possible	More pure lignin	125
Economic	Alcell-like	10.000 t per year of walnut shells	Extraction limitations and energy required	—	126
Economic ^a	Lignol-like and Alcell-like	—	High consumption of chemicals and energy for the recovery of solvents. High dependence on yield and value of products	—	127
Environmental ^a	Lignol-like	—	—	Environmentally friendly in terms of climate change impact	128
Economic	Alcell-like	2000 t d ⁻¹ of eucalyptus logs	The process is profitable when high-value chemicals are produced (lignin polyols and platform chemicals vs. technical lignin, sugars and ethanol)	—	129
Economic	Alcell-like	114 t h ⁻¹ of sugarcane bagasse	Economic point of view is the limitation of the process	—	130
Economic and Environmental	not reported	500 t d ⁻¹ wood	Depending on the value of final products, CO ₂ production is comparable with that of other processes, but other pollutants were not studied.	—	131
Economic and environmental	Lignol-like	40.000 t per year of wood chips	Economic point of view is the limitation of the process. Necessary for the production of high-value chemicals	Lower global warming potential (excluding biogenic carbon)	132
Economic and environmental	Fabiola	300.000 t per year dry biomass	Economic point of view is the limitation of the process. Improvement with respect of ethanol process.	Improved environmental impact compared to the ethanol process	133

^a Review article.

sive process that does not resolve the energy requirements already present in the organosolv process without significant improvements in the quality of the products.¹²⁴

Gurgel da Silva *et al.* compared different pre-treatment processes for the production of ethanol, studying the economic and environmental impacts. Diluted acid, liquid hot water, steam explosion, ammonia fibre explosion, and organosolv (Lignol-like) pre-treatments were considered. The target product is bioethanol. The process simulation was performed with the software Aspen Plus® v8.6, considering corn stover as

feedstock (97.000 kg h⁻¹ for 7920 h). The organosolv process showed the highest utility costs due to the recycling process and, consequently, the highest carbon dioxide emissions. Also, it is the only process where heat integration is not feasible. However, the organosolv process is the one able to extract pure lignin.¹²⁵

In 2020, a thesis described the simulation of a large-scale organosolv process (Alcell-like, 10.000 t per year of walnut shells) using Aspen Plus® software. The author reports the lack of data due to the novelty of the process at this scale,



causing difficulty in having accurate assumptions and simulations. The target product is organosolv lignin. The process is, at the moment, not economically feasible. The operating costs are currently too high due to the extraction limitations and energy required to recover the solvent. The options are to optimise the process (e.g. selecting a different organic solvent to boost the extraction and improve the solvent recovery system) and sell the lignin at higher prices.¹²⁶

Soltanian *et al.* studied the exergetic aspects of the pre-treatment process (diluted acid, organosolv and steam explosion) for converting lignocellulose to fuels. Different organosolv processes, Lignol-like and Alcell-like, were investigated. For exergy aspects, the organosolv process was found to be less efficient than steam exploded treatment due to the high consumption of chemicals and energy for the recovery of solvents. Moreover, organosolv efficiency is highly dependent on the effectiveness of recovery of lignin and hemicelluloses. Therefore, improving the fractionation stage and the method to recover the solvents¹²⁷ is necessary.

In 2021, Ryan and Yaseneva reported and compared in a review the LCA on different woody biomass treatments (e.g. organosolv, kraft pulping, and diluted acid) for its conversion to sugars. The results suggested that the organosolv process considered in the publication (Lignol-like) is the most environmentally friendly, particularly regarding climate change.¹²⁸

Dornelles *et al.* studied the economic aspects to valorise the eucalyptus. The author found that focusing on lignin, especially polyols, and commercialised sugar is more profitable than preparing cellulosic chemicals. Also, this organosolv approach (Alcell-like) is more profitable than producing ethanol, sugar and technical lignin. In this case, a plant with a capacity of 2000 dry tons of eucalyptus logs per day was considered.¹²⁹

Ospina-Varón *et al.* studied different pre-treatment processes: steam explosion, organosolv (Alcell-like) and hot water to obtain nanocellulose. Aspen Plus v10 was used as the simulation software. This work considered a feedstock flow of sugarcane bagasse of 114 t h⁻¹. The results show that the organosolv process has the best technical performance, but its economic behaviour is its biggest disadvantage.¹³⁰

Ouhimmou *et al.* used as a study case the forest industry in the Mauricie region (Canada). Different pre-treatments were considered: hot water extraction, fast pyrolysis, organosolv fractionation, and kraft pulping. The organosolv considered is not specified, but it was studied on a scale of 500 t d⁻¹ of wood. In summary, the profitability of the organosolv process is strongly influenced by the type of products generated during the process. In addition, this study evaluated greenhouse gas (CO₂) generation, showing that organosolv has a GHG generation comparable to other pre-treatments. However, replacing other common pollutants (such as sulphur) was not considered.¹³¹

In 2022, Zeilerbauer *et al.* simulated an organosolv biorefinery (Lignol-like, input 40.000 t per year of wood chips) to evaluate the techno-economic and LCA aspects. The biorefinery was compared with the process based on fossil resources to obtain

the target products, lignin monomers, lignin oligomers and C6 sugars. The organosolv biorefinery provided a lower global warming potential (excluding biogenic carbon) than its fossil counterparts. However, the process is not profitable with prices based on fossil references. Therefore, it is necessary to obtain products having higher market demand/price.¹³²

Keller *et al.* reported a technoeconomic and environmental assessment regarding the Fabiola process as part of the project UnRavel (no. 792004) considering different feedstocks (e.g. beech, birch and wheat straw) and the use of “ethanol organosolv” process as a reference. This report also studied the social impact of the organosolv processes considering aspects such as labour rights and safety. In this work, a plant with a capacity of 300.000 t per year of dry matter biomass was considered. The extracted products were valorised considering C5 fraction to produce xylonate, C6 fraction for acetone synthesis and lignin for the generation of polyols, fillers or combustion for energy reasons. The results of this work showed an enhancement of the Fabiola process with respect to the ethanol organosolv treatment in terms of environmental, economic and social impacts. In particular, the Fabiola process requires lower energy and solvent demand than the ethanol organosolv treatment. It is an improvement, but at the same time, the authors state that further steps are necessary to reach a satisfactory overall sustainability. The authors advise different actions such as the improvement of the ratio solvent/biomass, the optimisation of reactor design and the valorisation of the extracts for pharmaceutical and cosmetic applications.¹³³

From the chemical point of view, the limitation in the use and recovery of organic solvents depends on the nature of the solvent. Methanol is not produced from a renewable resource and presents toxicity problems, ethanol presents limitations in its recovery due to the formation of azeotropes with water, acetone requires elevated operating pressures when high acetone volume fractions are present, and other organic solvents show boiling points higher than 100 °C (e.g. glycerol, acetic acid, formic acid and 1-butanol).^{134–136}

Another limitation of the organosolv process is to find the conditions to extract at the same time all four main components, extractives, hemicelluloses, cellulose and lignin. If extractives, cellulose and lignin are quite chemically and thermally stable, they are not the same as hemicellulose, which can be depolymerised by temperature and chemicals used during organosolv fractionation, causing the formation of monosaccharides and by-products that require specific techniques to be isolated.²⁸

6. Future opportunities

As described in the previous section, the scaling up of the organosolv process presents different limitations, notably the purchase of the solvent and the energy consumption for the disruption of the lignocellulosic structure and solvent recovery (Table 4). At the same time, this process shows several advan-



tages concerning other pre-treatments, such as environmental impact, the highest purity of the resulting lignin and flexibility from the point of view of the types of biomasses used as feedstock and the operative parameters (e.g. 120–200 °C, 1–40 bars and type of solvent) that can be optimised (Tables 1 and 4). Consequently, the field for the organosolv process scaling up requires further research offering a wide range of opportunities for researchers such as organic chemists, inorganic chemists, and chemical engineers.

An opportunity is the study of new green solvents. Several authors are working to find alternatives to the current organosolv processes, for example, the use of other organic solvents such as dimethyl carbonate mixed with ethylene glycol,¹³⁷ ethyl lactate mixed with ethanol¹³⁸ and MeTHF-3-one mixed with water.¹³⁹ Already the use of acetone was an improvement with respect to ethanol,¹³³ and the use of formic acid allows the scaling up of the Formico process at the industrial scale, which is expected in 2027. Moreover, the optimisation of the organosolv process is a crucial aspect, studying how to reduce the energy necessary for solvent recovery and lignin depolymerisation and isolation. For example, new catalysts can be used to improve fractionation,¹⁴⁰ the process can be optimised by studying a reactor that improves the contact fibres-solvent, and different optimisation studies can be performed by the design of experiments and simulation models.^{141–143} The energy optimisation can also be achieved using alternative heating methods such as ultrasound, microwaves and electrical energy.¹³⁵ Moreover, the use of the spent liquor before the stage of solvent recovery, or the use of biphasic systems to extract the chemicals from the organic solvent used for the fractionation can be considered.¹³⁴ The use of the organosolv process in combination with other pre-treatments also has to be considered, such as ionsolv²⁰ and liquid hot water processes.¹⁴⁴ Also, the scaling up of the organosolv process using alternative feedstocks, such as waste paper,²¹ can be evaluated.

Of course, a constant study of LCA and techno-economic analysis are crucial to define the energy consumption and, in the suitable case, select the best location for the organosolv plant. In particular, more studies on organosolv processes based on organic acids are important because the main analyses are made on ethanol-based organosolv pre-treatments. In fact, the Lignol process is the most studied.

Another area of interest is the synthesis of new high-added-value products (chemical and biomaterials), having a high price, to make the organosolv process profitable.^{145,146} In this field, there will be interest in isolated lignin, polysaccharides and extractives. For example, lignins having a high content of carboxylic acids can be used for the preparation of polymers such as polyesters, and lignin with a high content of hydroxyl groups can be used for the preparation of polymers having covalent adaptable networks to improve the recycling of thermoset materials such as resins.^{147,148} It is important to underline that the preparation of such materials is possible thanks to the purity and limited dispersity of the organosolv lignin. Otherwise, the lignin must be purified and fractionated. Moreover, the depolymerised hemicelluloses streams

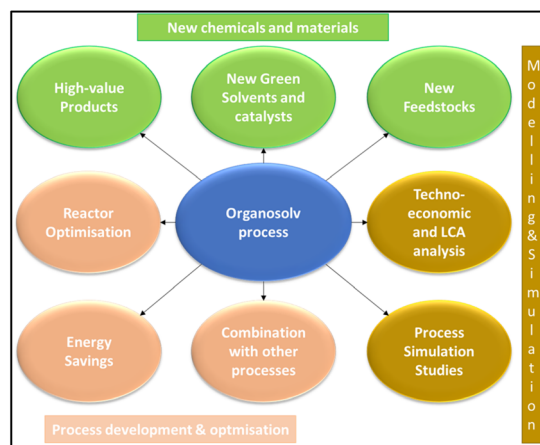


Fig. 13 Research topics for the optimisation of the organosolv process.

can be valorised by separation using nano- and ultra-filtration¹⁴⁹ or by modification *in situ* without purification stages for the production of valuable chemicals such as 5-hydroxymethylfurfural.¹⁵⁰

A question that has also been answered is if the organosolv process allows the industries to produce specialties and high added value products and not commodities, do we need plants operating at high scales such as 400 000 t per year?

A summary of the most interesting research field regarding the improvement and development of the organosolv process is reported in Fig. 13.

7. Conclusions

In conclusion, the organosolv process presents several interesting aspects for the development of biorefineries. The main elements are flexibility because the process can be applied to different biomasses, the possibility of extraction and isolation of all the lignocellulosic components, such as highly pure lignin, cellulose, hemicelluloses and extractives, and the reduction of the environmental impact in comparison with traditional pulping processes. Several organosolv fractionation methods have been studied (*i.e.* Alcell and Acetosolv) over the years, and new processes are under study (*i.e.* Bloom and Fraction project). Currently, five pilot plants (500–1000 tons per year of lignin generated) are operational in Europe, North America and Oceania. The main solvents are ethanol, formic acid, and acetic acid in the presence or not of sulfuric acid. The commercialisation scale has still to be reached, but Fortum Oyj and Chempolis Oy are collaborating to achieve that goal. The limitations of the organosolv scale-up are mainly correlated with the energy consumption and the costs of the solvents. However, several aspects can be improved and optimised. The main fields are the study of new raw materials, the development of high value products in order to make the process more profitable, the optimisation of the entire process from the point of view of the reactor and energy optimisation



and the simulation and modelling studies, in particular for techno-economic analysis and LCA. Therefore, the scaling up of organosolv fractionation offers several research opportunities for scientists from different areas, such as organic chemistry, inorganic chemistry, and chemical engineering.

Author contributions

G.T and B.L. worked on the conceptualization. G.T. and E.J.G. prepared the draft of the manuscript, and B.L. and M.G. performed the final editing. The manuscript was written through the contributions of all authors.

Conflicts of interest

There are no conflicts to declare.

Acknowledgements

The authors acknowledge the financial support provided by the Slovenian Research Agency (P2-0152 and J2-2492) and the European projects ESTELLA (GA ID: 101058371), HyPELignum (GA ID: 101070302) and GREEN-LOOP (GA ID: 101057765).

References

- M. Boro, A. K. Verma, D. Chettri, V. K. Yata and A. K. Verma, *Environ. Technol. Innovation*, 2022, **28**, 102679.
- S. Sadula, N. Rodriguez Quiroz, A. Athaley, E. O. Ebikade, M. Ierapetritou, D. G. Vlachos and B. Saha, *Green Chem.*, 2021, **23**, 1200–1211.
- G. Tofani, I. Cornet and S. Tavernier, *Chem. Pap.*, 2022, **76**, 4351–4365.
- G. Tofani, I. Cornet and S. Tavernier, *Chem. Pap.*, 2021, **75**, 5749–5758.
- S. Balda, A. Sharma, N. Gupta, N. Capalash and P. Sharma, *Biomass Convers. Biorefin.*, 2022, DOI: [10.1007/s13399-022-02509-x](https://doi.org/10.1007/s13399-022-02509-x).
- J. Leon, C. Aliaga, G. Boulougouris, M. Hortal and J. L. Marti, *J. Cleaner Prod.*, 2015, **103**, 301–308.
- X. Shen and R. Sun, *Carbohydr. Polym.*, 2021, **261**, 117884.
- I. Vera, R. Hoefnagels, A. Kooij, C. Moretti and M. Junginger, *Biofuels, Bioprod. Biorefin.*, 2020, **14**, 198–224.
- G. Velvizhi, C. Goswami, N. P. Shetti, E. Ahmad, K. Kishore Pant and T. M. Aminabhavi, *Fuel*, 2022, **313**, 122678.
- Y. Luo, M. Wei, B. Jiang, M. Zhang, Q. Miao, H. Fu, J. H. Clark and J. Fan, *Green Chem.*, 2022, **24**, 7429–7441.
- S. Rahmati, L. Atanda, M. Horn, K. D. Athukoralalage Don, J. Jimenez Forero, L. Moghaddam, D. Dubal, K. Ostrikov and W. O. S. Doherty, *Green Chem.*, 2022, **24**, 7410–7428.
- D. Tarasov, P. Schlee, A. Pranovich, A. Moreno, L. Wang, D. Rigo, M. H. Sipponen, C. Xu and M. Balakshin, *Green Chem.*, 2022, **24**, 6639–6656.
- Q. Chu, W. Tong, S. Wu, Y. Jin, J. Hu and K. Song, *Green Chem.*, 2021, **23**, 4074–4086.
- G. Tofani, J. de Nys, I. Cornet and S. Tavernier, *Waste Biomass Valorization*, 2021, **12**, 503–514.
- G. Tofani, I. Cornet and S. Tavernier, *Biomass Convers. Biorefin.*, 2022, **12**, 3409–3424.
- D. Mboowa, *Biomass Convers. Biorefin.*, 2021, DOI: [10.1007/s13399-020-01243-6](https://doi.org/10.1007/s13399-020-01243-6).
- A. A. Vaidya, K. D. Murton, D. A. Smith and G. Dedual, *Biomass Convers. Biorefin.*, 2022, **12**, 5427–5442.
- A. E. Kazzaz and P. Fatehi, *Ind. Crops Prod.*, 2020, **154**, 112732.
- M. Galbe and O. Wallberg, *Biotechnol. Biofuels*, 2019, **12**, 294.
- M. Chen, F. Malaret, A. E. J. Firth, P. Verdía, A. R. Abouelela, Y. Chen and J. P. Hallett, *Green Chem.*, 2020, **22**, 5161–5178.
- M. S. Jahan, M. M. Rahman and A. M. Sarkar, *Cellulose*, 2016, **23**, 2039–2047.
- B. Rietzler, M. Karlsson, I. Kwan, M. Lawoko and M. Ek, *Biomacromolecules*, 2022, **23**, 3349–3358.
- M. Lee, M. Yang, S. Choi, J. Shin, C. Park, S.-K. Cho and Y. M. Kim, *Energies*, 2019, **12**, 2360.
- A. Paz, A. Karnaouri, C. C. Templis, N. Papayannakos and E. Topakas, *Waste Manage.*, 2020, **118**, 435–444.
- J. Lange, F. Müller, R. Takors and B. Blombach, *J. Microb. Biotechnol.*, 2018, **11**, 257–263.
- L. R. Mugwagwa and A. F. A. Chimphango, *Int. J. Biol. Macromol.*, 2020, **143**, 862–872.
- F. P. Bouxin, S. D. Jackson and M. C. Jarvis, *Bioresour. Technol.*, 2014, **151**, 441–444.
- J. Köchermann, J. Mühlenberg and M. Klemm, *Ind. Eng. Chem. Res.*, 2018, **57**, 14417–14427.
- A. A. Schmatz, F. Masarin and M. Brienzo, *Bioenergy Res.*, 2022, **15**, 1107–1115.
- R. Terán Hilaes, M. P. Swerts, M. A. Ahmed, L. Ramos, S. S. da Silva and J. C. Santos, *Ind. Eng. Chem. Res.*, 2017, **56**, 3833–3838.
- X. Zhao, F. Cheng, Y. Hu and R. Cheng, *J. Nat. Fibers*, 2021, 1–12.
- V. A. Barbash, O. V. Yashchenko and V. O. Opolsky, *Theor. Exp. Chem.*, 2018, **54**, 193–198.
- M. N. Muraleedharan, A. Karnaouri, M. Piatkova, M.-X. Ruiz-Caldas, L. Matsakas, B. Liu, U. Rova, P. Christakopoulos and A. P. Mathew, *Int. J. Biol. Macromol.*, 2021, **183**, 101–109.
- R. Zhang and Y. Liu, *Sci. Rep.*, 2018, **8**, 16505.
- N. Aggarwal, P. Pal, N. Sharma and S. Saravanamurugan, *ACS Omega*, 2021, **6**, 27247–27258.
- M. Yáñez-S, B. Matsuhira, S. Maldonado, R. González, J. Luengo, O. Uyarte, D. Serafine, S. Moya, J. Romero, R. Torres and M. J. Kogan, *Cellulose*, 2018, **25**, 2901–2914.



- 37 D. C. Martino, J. L. Colodette, R. Chandra and J. Saddler, *Wood Sci. Technol.*, 2017, **51**, 557–569.
- 38 P. Jöul, T. T. Ho, U. Kallavus, A. Konist, K. Leiman, O.-S. Salm, M. Kulp, M. Koel and T. Lukk, *Materials*, 2022, **15**, 2861.
- 39 S. Bergamasco, S. Tamantini, F. Zikeli, V. Vinciguerra, G. Scarascia Mugnozza and M. Romagnoli, *Polymers*, 2022, **14**, 416.
- 40 G. Lavrič, A. Zamljen, J. Juhant Grkman, E. Jasiukaitytė-Grojzdek, M. Grilc, B. Likozar, D. Gregor-Svetec and U. Vrabčič-Brodnjak, *Polymers*, 2021, **13**, 4443.
- 41 J. A. Menima-Medzogo, K. Walz, J. C. Lauer, G. Sivasankarapillai, F. R. Gleuwitz, B. Rolauuffs, M.-P. Laborie and M. L. Hart, *Biology*, 2022, **11**, 696.
- 42 Z.-H. Liu, N. Hao, S. Shinde, Y. Pu, X. Kang, A. J. Ragauskas and J. S. Yuan, *Green Chem.*, 2019, **21**, 245–260.
- 43 K. Hružová, L. Matsakas, A. Sand, U. Rova and P. Christakopoulos, *Bioresour. Technol.*, 2020, **306**, 123235.
- 44 J. Adamczyk, S. Beisl, S. Amini, T. Jung, F. Zikeli, J. Labidi and A. Friedl, *Polymers*, 2021, **13**, 384.
- 45 G. Sivasankarapillai, E. Eslami and M.-P. Laborie, *ACS Sustainable Chem. Eng.*, 2019, **7**, 12817–12824.
- 46 S. Feng, T. Shui, H. Wang, X. Ai, T. Kuboki and C. C. Xu, *Ind. Crops Prod.*, 2021, **161**, 113225.
- 47 J. Saražin, A. Pizzi, S. Amirou, D. Schmiedl and M. Šernek, *J. Renewable Mater.*, 2021, **9**, 881–907.
- 48 V. Mimini, E. Sykacek, S. N. A. Syed Hashim, J. Holzweber, H. Hettegger, K. Fackler, A. Potthast, N. Mundigler and T. Rosenau, *J. Wood Chem. Technol.*, 2019, **39**, 14–30.
- 49 F. Ibrahim, D. Mohan, M. S. Sajab, S. B. Bakarudin and H. Kaco, *Polymers*, 2019, **11**, 1544.
- 50 J. T. Sutton, K. Rajan, D. P. Harper and S. C. Chmely, *Polymers*, 2021, **13**, 3473.
- 51 A. Ghosh, K. Kim, K. Rajan, C. C. Bowland, R. N. Gurram, R. W. Montgomery, A. Manesh, N. Labbé and A. K. Naskar, *Ind. Eng. Chem. Res.*, 2019, **58**, 20300–20308.
- 52 W. Huang, M. Wu, K. Rajan, Z. Wang and L. Zhou, *Ind. Crops Prod.*, 2021, **159**, 113062.
- 53 S. E. Klein, J. Rumpf, A. Alzagameem, M. Rehahn and M. Schulze, *J. Coat. Technol. Res.*, 2019, **16**, 1543–1552.
- 54 Y. Zhang, X. Liu, P. Apostolidis, R. Jing, S. Erkens, N. Poeran and A. Skarpas, *Molecules*, 2020, **25**, 2455.
- 55 M. Michelin, A. M. Marques, L. M. Pastrana, J. A. Teixeira and M. A. Cerqueira, *J. Food Eng.*, 2020, **285**, 110107.
- 56 W. Huang, M. Wu, W. Liu, Z. Hua, Z. Wang and L. Zhou, *Appl. Surf. Sci.*, 2019, **475**, 302–311.
- 57 Z. Wang, W. Huang, P. Bin, X. Zhang and G. Yang, *Int. J. Biol. Macromol.*, 2019, **126**, 1014–1022.
- 58 Z. Chi, L. Hao, H. Dong, H. Yu, H. Liu, Z. Wang and H. Yu, *Chem. Eng. J.*, 2020, **382**, 122789.
- 59 M. Fodil Cherif, D. Trache, F. Benaliouche, A. F. Tarchoun, S. Chelouche and A. Mezroua, *Int. J. Biol. Macromol.*, 2020, **164**, 794–807.
- 60 S. J. Marciano, F. Avelino, L. R. R. da Silva, S. E. Mazzetto and D. Lomonaco, *Biomass Convers. Biorefin.*, 2022, **12**, 619–631.
- 61 A. Abid, N. Brosse, I. Ziegler-Devin and S. Gabsi, *J. Polym. Res.*, 2020, **27**, 266.
- 62 O. Gordobil, R. Herrera, M. Yahyaoui, S. İlk, M. Kaya and J. Labidi, *RSC Adv.*, 2018, **8**, 24525–24533.
- 63 L. de Sousa Nascimento, F. I. D. da Mata Vieira, V. Horácio, F. P. Marques, M. F. Rosa, S. A. Souza, R. M. de Freitas, D. E. A. Uchoa, S. E. Mazzetto, D. Lomonaco and F. Avelino, *Int. J. Biol. Macromol.*, 2021, **181**, 241–252.
- 64 Q. Gu, T. L. Eberhardt, J. Shao and H. Pan, *J. Appl. Polym. Sci.*, 2022, **139**, 52003.
- 65 E. K. Pye and J. H. Lora, *Tappi J.*, 1991, **74**, 113–117.
- 66 Alcell Technologies Inc., US005681427A, 1997.
- 67 M. C. Schroeter, *Tappi J.*, 1991, **74**, 197–200.
- 68 Organocell Gesellschaft fuer zellstoff und Umwelttechnik MBH, EP0498330A1, 1992.
- 69 S. Aziz and K. Sarkanen, *Tappi J.*, 1989, **72**, 162–175.
- 70 X. Pan, C. Arato, N. Gilkes, D. Gregg, W. Mabee, K. Pye, Z. Xiao, X. Zhang and J. Saddler, *Biotechnol. Bioeng.*, 2005, **90**, 473–481.
- 71 Lignol Innovations LTD, A. Berlin, M. Y. Balakshin, R. MA, V. Maximenko Gutman and D. Ortiz, WO2011097720A1, 2011.
- 72 N. P. Black, *Tappi J.*, 1991, **74**, 87–93.
- 73 Austrian Energy & Environment SGP/Waagner-Biro GMBH, EP0538576A1, 1992.
- 74 H. Kirçi, S. Bostançi and M. K. Yalinkiliç, *Wood Sci. Technol.*, 1994, **28**, 89–99.
- 75 B. Lesar, M. Humar, G. Hora, P. Hachmeister, D. Schmiedl, E. Pindel, M. Siika-aho and T. Liitiä, *Eur. J. Wood Wood Prod.*, 2016, **74**, 711–723.
- 76 P. Schulze, A. Seidel-Morgenstern, H. Lorenz, M. Leschinsky and G. Unkelbach, *Bioresour. Technol.*, 2016, **199**, 128–134.
- 77 I. Van Nieuwenhove, T. Renders, J. Lauwaert, T. De Roo, J. De Clercq and A. Verberckmoes, *ACS Sustainable Chem. Eng.*, 2020, **8**, 18789–18809.
- 78 Leaf Sciences Pty Ltd, EP3167112B1, 2021.
- 79 A. T. Smit, M. Verges, P. Schulze, A. van Zomeren and H. Lorenz, *ACS Sustainable Chem. Eng.*, 2022, **10**, 10503–10513.
- 80 A. Smit and W. Huijgen, *Green Chem.*, 2017, **19**, 5505–5514.
- 81 Stichting Energieonderzoek Centrum Nederland, *Nederlandse Organisatie voor Toegepast-Natuurwetenschappelijk Onderzoek*, TNO, n.d. US10793927B2, 2020.
- 82 M. Iakovlev and A. van Heiningen, *J. Wood Chem. Technol.*, 2011, **31**, 233–249.
- 83 E. Sklavounos, Conditioning of SO₂-ethanol-water (SEW) spent liquor from lignocellulosics for ABE fermentation to biofuels and chemicals, Aalto University, 2014.
- 84 A. Van Heiningen, E. Sklavounos, Api Intellectual Property Holdings, LLC, US2014004582A1, 2014.
- 85 P. D. Kouris, X. Huang, X. Ouyang, D. J. G. P. van Osch, G. J. W. Cremers, M. D. Boot and E. J. M. Hensen, *Catalysts*, 2021, **11**, 750.



- 86 B. V. Vertoro, EP3798286A1, 2021.
- 87 Vertoro, <https://vertoro.com/technology/>, (accessed October 11, 2022).
- 88 American Science and Technology Corporation, US9365525B2, 2016.
- 89 E. Ramírez, R. Bringué, C. Fité, M. Iborra, J. Tejero and F. Cunill, *Appl. Catal., A*, 2021, **612**, 117988.
- 90 P. Ligeró, A. Vega and M. Bao, *Ind. Crops Prod.*, 2005, **21**, 235–240.
- 91 Acetocell, GMBH and CO. KG, EP0503304A1, 1992.
- 92 Nimz, H. Horst, DE3445132A1, 1986.
- 93 J. J. Villaverde, P. Ligeró and A. Vega, *Ind. Crops Prod.*, 2015, **77**, 275–281.
- 94 Gebrüder Kammerer Projekt Agentus GMBH, US6139683A, 2000.
- 95 A. Ferrer, A. Vega, A. Rodríguez, P. Ligeró and L. Jiménez, *Bioresour. Technol.*, 2011, **102**, 9755–9762.
- 96 Chempolis OY, US6156156A, 2000.
- 97 L. Kupiainen, J. Ahola and J. Tanskanen, *Bioresour. Technol.*, 2012, **116**, 29–35.
- 98 J. Anttila, J. Tanskanen, P. Rousu, P. Rousu and K. Hytoenen, US2010240112A1, 2010.
- 99 F. Abdelkafi, H. Ammar, B. Rousseau, M. Tessier, R. El Gharbi and A. Fradet, *Biomacromolecules*, 2011, **12**, 3895–3902.
- 100 A. D. Mountraki, B. Benjelloun-Mlayah and A. C. Kokossis, *Front. Chem. Eng.*, 2020, **2**, 568196.
- 101 Compagnie Industrielle de la Matière Végétale CIMV, US2010285553A1, 2010.
- 102 Valtion teknillinen tutkimuslaitos, H. Mikkonen, S. Peltonen, A. Kallioinen, A. Suurnaekki, V. Kunnari and T. Malm, WO2009066007A2, 2009.
- 103 H. Kangas, T. Tamminen, T. Liitia, T. K. Hakala, W. Vorwerg and K. Poppus-Levlin, *Cellul. Chem. Technol.*, 2014, **48**, 765–771.
- 104 Ecole Polytechnique Federale de Lausanne, WO2017178513A1, 2017.
- 105 S. Bertella and J. S. Luterbacher, *Green Chem.*, 2021, **23**, 3459–3467.
- 106 L. Shuai, M. T. Amiri, Y. M. Questell-Santiago, F. Héroguel, Y. Li, H. Kim, R. Meilan, C. Chapple, J. Ralph and J. S. Luterbacher, *Science*, 2016, **354**, 329–333.
- 107 J. Bergrath, J. Rumpf, R. Burger, X. T. Do, M. Wirtz and M. Schulze, *Macromol. Mater. Eng.*, 2023, **308**, 2300093.
- 108 S. Mastrolitti, E. Borsella, A. Giuliano, M. T. Petrone, I. De Bari, R. Gosselink, G. van Erven, E. Annevelink, K. S. Triantafyllidis and H. Stichnothe, Sustainable lignin valorization, <https://www.icabioenergy.com/blog/publications/sustainable-lignin-valorization/>, (accessed October 11, 2022).
- 109 Glycell, <https://leafresources.com.au/uncategorized/manufacturing/rebuilding-and-upgrading/>, (accessed October 11, 2022).
- 110 American Science and Technology corporation, RFI Category 2 - LIGNIN, [extension://elhekieabhbkmcefc-coobjddjgcaadp/https://www.energy.gov/sites/prod/files/2016/10/f33/american_science_and_technology_de_foa_0001615_lignin_0.pdf](https://www.energy.gov/sites/prod/files/2016/10/f33/american_science_and_technology_de_foa_0001615_lignin_0.pdf), (accessed October 11, 2022).
- 111 Fraction project, <https://fraction-project.eu/>, (accessed October 11, 2022).
- 112 Bloom Biorenewables, <https://www.bloombiorenewables.com/>, (accessed October 11, 2022).
- 113 Sekab website, Sekab and Vertoro to build large-scale demonstration plant to produce a new platform for sustainable fuels, chemicals, and materials, <https://www.sekab.com/en/press-releases/sekab-and-vertoro-to-build-large-scale-demonstration-plant-to-produce-a-new-platform-for-sustainable-fuels-chemicals-and-materials/>, (accessed October 11, 2022).
- 114 H. Wikberg, in *Development steps in commercialization of organosolv lignin, The FinnCERES Scientific Seminar 2022 Back to Fundamentals - Fibre, Water & Interactions*, Espoo, Finland, 2022.
- 115 R. Nitzsche, M. Budzinski and A. Gröngröft, *Bioresour. Technol.*, 2016, **200**, 928–939.
- 116 M. Budzinski and R. Nitzsche, *Bioresour. Technol.*, 2016, **216**, 613–621.
- 117 X. Zhao, S. Li, R. Wu and D. Liu, *Biofuels, Bioprod. Biorefin.*, 2017, **11**, 567–590.
- 118 J. Moncada, I. Vural Gursel, W. J. J. Huijgen, J. W. Dijkstra and A. Ramírez, *J. Cleaner Prod.*, 2018, **170**, 610–624.
- 119 A. Rodrigues Gurgel da Silva, M. Errico and B.-G. Rong, *Clean Technol. Environ. Policy*, 2018, **20**, 1401–1412.
- 120 C. I. Santos, C. C. Silva, S. I. Mussatto, P. Osseweijer, L. A. M. van der Wielen and J. A. Posada, *Renewable Energy*, 2018, **129**, 733–747.
- 121 S. Bello, C. Ríos, G. Feijoo and M. T. Moreira, *Biofuels, Bioprod. Biorefin.*, 2018, **12**, 1047–1064.
- 122 M. K. Patel, A. Bechu, J. D. Villegas, M. Bergez-Lacoste, K. Yeung, R. Murphy, J. Woods, O. N. Mwabonje, Y. Ni, A. D. Patel, J. Gallagher and D. Bryant, *Biofuels, Bioprod. Biorefin.*, 2018, **12**, 426–441.
- 123 M. Nieder-Heitmann, K. Haigh, J. Louw and J. F. Görgens, *Biofuels, Bioprod. Biorefin.*, 2020, **14**, 55–77.
- 124 S. Mesfun, L. Matsakas, U. Rova and P. Christakopoulos, *Energies*, 2019, **12**, 4206.
- 125 A. Rodrigues Gurgel da Silva, A. Giuliano, M. Errico, B.-G. Rong and D. Barletta, *Clean Technol. Environ. Policy*, 2019, **21**, 637–654.
- 126 A. Herry, *Large Scale Lignin Organosolv Extraction*, University of Groningen, 2020.
- 127 S. Soltanian, M. Aghbashlo, F. Almasi, H. Hosseinzadeh-Bandbafha, A.-S. Nizami, Y. S. Ok, S. S. Lam and M. Tabatabaei, *Energy Convers. Manage.*, 2020, **212**, 112792.
- 128 N. Ryan and P. Yaseneva, *Philos. Trans. R. Soc., A*, 2021, **379**, 20200335.
- 129 L. B. Dornelles, R. M. Filho and A. P. Mariano, *Ind. Crops Prod.*, 2021, **173**, 114097.
- 130 R. A. Ospina-Varón, F. E. López-Suárez and V. Aristizábal-Marulanda, *Biomass Convers. Biorefin.*, 2022, **12**, 4245–4256.



- 131 M. Ouhimmou, M. Rönqvist and L.-A. Lapointe, *Omega*, 2021, **99**, 102173.
- 132 L. Zeilerbauer, J. Lindorfer, R. Süß and B. Kamm, *Biofuels, Bioprod. Biorefin.*, 2022, **16**, 370–388.
- 133 K. Heiko, S. Julian, R. Guido, G. Sven and R. Nils, Integrated sustainability assessment of an innovative lignocellulose biorefinery concept based on the acetone organosolv process, UNRAVEL project GA No. 792004, EU Horizon 2020, <https://www.ifeu.de/en/project/unravel/>.
- 134 D. W. K. Chin, S. Lim, Y. L. Pang and M. K. Lam, *Biofuels, Bioprod. Biorefin.*, 2020, **14**, 808–829.
- 135 L. G. Nair, K. Agrawal and P. Verma, *Bioresour. Bioprocess.*, 2023, **10**, 50.
- 136 P. P. Thoresen, L. Matsakas, U. Rova and P. Christakopoulos, *Bioresour. Technol.*, 2020, **306**, 123189.
- 137 A. De Santi, M. V. Galkin, C. W. Lahive, P. J. Deuss and K. Barta, *ChemSusChem*, 2020, **13**, 4468–4477.
- 138 Á. Valdespino-Rodríguez, D. J. Pérez-Martín, M. F. González-Barajas, H. Villicaña-Ambriz, D. Campos-Castellanos, F. M. Escalante, A. Sánchez and E. Aguilar-Garnica, *J. Chem. Technol. Biotechnol.*, 2020, **95**, 594–603.
- 139 M. E. Vuillemin, M. C. Quesada-Salas, C. Hadad, J. Jasniewski, E. Husson and C. Sarazin, *RSC Sustainability*, 2023, **1**, 853–865.
- 140 G. T. Wurzler, V. T. da Silva, D. de Almeida Azevedo, A. S. Ana da Silva and F. B. Noronha, *Fuel Process. Technol.*, 2022, **230**, 107208.
- 141 D. Pradhan, S. Jaiswal and A. K. Jaiswal, *Biofuels, Bioprod. Biorefin.*, 2022, **16**, 1849–1868.
- 142 D. Sidiras, D. Politi, G. Giakoumakis and I. Salapa, *Bioresour. Technol.*, 2022, **343**, 126158.
- 143 M. Karlsson, V. L. Vegunta, R. Deshpande and M. Lawoko, *Green Chem.*, 2022, **24**, 1211–1223.
- 144 S. Serna-Loaiza, J. Adamcyk, S. Beisl, M. Miltner and A. Friedl, *Waste Biomass Valorization*, 2022, **13**, 4771–4784.
- 145 N. Asadi, M. Karimi Alavijeh and H. Zilouei, *Int. J. Hydrogen Energy*, 2018, **43**, 8718–8728.
- 146 O. Gordobil, R. Herrera, M. Yahyaoui, S. İlk, M. Kaya and J. Labidi, *RSC Adv.*, 2018, **8**, 24525–24533.
- 147 C. Scarica, R. Suriano, M. Levi, S. Turri and G. Griffini, *ACS Sustainable Chem. Eng.*, 2018, **6**, 3392–3401.
- 148 D. B. Tiz, F. A. Vicente, A. Kroflič and B. Likozar, *ACS Sustainable Chem. Eng.*, 2023, **11**, 13836–13867.
- 149 R. Nitzsche, H. Etzold, M. Verges, A. Gröngröft and M. Kraume, *Membranes*, 2022, **12**, 82.
- 150 R. M. Abdilla-Santes, W. Guo, P. C. A. Bruijninx, J. Yue, P. J. Deuss and H. J. Heeres, *ChemSusChem*, 2019, **12**, 4304–4312.

