

Analytical Methods

Accepted Manuscript



This is an *Accepted Manuscript*, which has been through the Royal Society of Chemistry peer review process and has been accepted for publication.

Accepted Manuscripts are published online shortly after acceptance, before technical editing, formatting and proof reading. Using this free service, authors can make their results available to the community, in citable form, before we publish the edited article. We will replace this *Accepted Manuscript* with the edited and formatted *Advance Article* as soon as it is available.

You can find more information about *Accepted Manuscripts* in the [Information for Authors](#).

Please note that technical editing may introduce minor changes to the text and/or graphics, which may alter content. The journal's standard [Terms & Conditions](#) and the [Ethical guidelines](#) still apply. In no event shall the Royal Society of Chemistry be held responsible for any errors or omissions in this *Accepted Manuscript* or any consequences arising from the use of any information it contains.

ARTICLE

sCite this: DOI:
10.1039/x0xx00000x
www.rsc.org/

The development of paper microfluidic devices for presumptive drug detection.

Giacomo Musile,^{1,2} Ling Wang¹, Jashaun Bottoms¹, Franco Tagliaro² and Bruce McCord¹

A paper microfluidic device has been developed for the presumptive testing of seized drugs in forensic casework. The procedure involves creating hydrophilic channels on chromatographic paper using wax printing and thermal lamination. The channels are connected to a single stem that draws an unknown analyte solution up into 6 different lanes. A different colorimetric reaction occurs within each lane, permitting the multiplexed detection of a variety of different compounds, including cocaine, opiates, ketamine, and various phenethyl amines. Furthermore, the linear orientation of the lanes permits series of reactants to be placed in each channel, enhancing stability and permitting sequential interaction with the analyte as the solvent front passes through each individual reagent. The resultant device was characterized for sensitivity and tested with a variety of common interferences and drug diluents. It should prove a useful device for screening seized drugs.

Introduction

In spite of an increasing awareness of the need to reduce the worldwide spread of illicit drugs, the abuse of psychotropic substances continues to be a rising phenomenon. Seizures of cocaine, heroin and illicit morphine and cannabis have all increased from 2003 to 2012. Up until 2010 the rate of seizures of amphetamine type stimulants rose at a similar rate; however, recently the rate has tripled. Although half of all amphetamine-type stimulants were seized in North America, the number of seizures of these compounds continues to increase in the Middle East, while Africa and Asia are emerging as new markets for these drugs.¹

In most forensic laboratories the detection of seized drugs involves a two-step process in which a rapid presumptive test is used for screening followed by a more accurate, identifying step using spectrometric instrumentation.² Typically, presumptive tests are much less inexpensive, and permit on-site measurements by unskilled handlers. The response from these tests must be rapid and the devices performing these tests need to merge chemistry, signal recognition and processing into

a single integrated process.³ A variety of presumptive methods have been developed, including spot tests, chemical microscopy, TLC, GC and IR but many of these tests require skilled handlers, or like spot tests⁴ are incapable of simultaneously determining a wide variety of compounds in a single tube analysis step. A cheaper, simpler on-site test capable of performing multiplex sample analysis is needed.

Microfluidic paper-based analytical devices (μ PADs) with colorimetric detection are a potential solution to this problem. These devices involve chemical or enzymatic tests, which can be segregated and multiplexed by placing them within wax channels printed on chromatographic paper. The sample solution moves in an area delineated by hydrophobic barriers, toward the immobilized reagent via capillary action. These systems rely on simple chemical reactions, and produce visible results that can be interpreted with the naked-eye. Analytical response is obtained in a few minutes, and the measurement can be performed on-site.

μ PADs were originally developed for applications involving medical testing in third-world countries⁵ and have been used for a variety of applications including

the estimation of glucose and protein⁵, uric acid⁶, ketones⁷, lactate⁸, total iron⁹ and pathogenic bacteria¹⁰. Several fabrication methods have been used to obtain microfluidic devices.⁵ The fabrication procedure involves the use of a commercial wax printer and chromatographic paper to create channels in which different reagents are placed.¹¹ Semi-quantitative analysis can be performed through the use of digital image scanners or cameras.¹² The resulting devices permit a quick, inexpensive, determination of a wide variety of analytes.

In this project we have developed a set of paper microfluidic colorimetric tests for the analysis of seized drugs. To the best of our knowledge this work presents a unique process for running multiple assays simultaneously. The test can detect a wide variety of analytes using only a few micrograms of sample solution. Semi-quantitative analysis is also possible using a smartphone and simple software. The proposed method doesn't require highly qualified persons or expensive instrumentation, and it can be performed on-site enabling a prompt analytical response during police actions, border services, and airport security.

Experimental

Chemicals

All chemicals were analytical grade. Cobalt thiocyanate was purchased from Aldrich; iron (III) chloride and glycerol were purchased from Acros Organics (Waltham, MA, United States); fast blue B, molybdc acid, ninhydrin were purchased from Sigma-Aldrich (St. Louis, MO, Unites States); potassium permanganate, sodium hydroxide, hydrochloric acid and acetone were purchased from Fisher (Pittsburgh, PA, United States). Amphetamine (Amp), methamphetamine (MA), cocaine (Coc), ketamine (Ket), ephderine (Eph) were purchased from Sigma (StLouis, MO, United States), morphine (Morp), codeine (Cod) and thebaine (The) were purchased from RBI (Natick, MA, United States). For each drug, a solution 100 mg/mL in 50% acetone/50% deionized water was prepared before each analysis.

Interference testing

Lidocaine and procaine were purchased from Acros Organics (Waltham, MA, United States), quinine was purchased from J. T. Baker Inc. (Philipsburg, NJ, United States) and caffeine was purchased from Sigma-Aldrich (St. Louis, MO, United States).

Dimethylsulfone, lactose, mannitol, inositol were obtained from Fisher (Pittsburgh, PA, United States). King Arthur gluten free flour, Arm & Hammer baking soda, Publix granulated sugar, Rumford aluminium free baking powder, Shower Bath Salt absorbent body powder, iodized salt, Publix antacid tablets, and Argo 100% pure corn starch were purchased from supermarkets in Miami, FL, United States. Prior to analysis a solution or slurry of each interferent was prepared at a concentration of 100 mg/mL in 50% acetone/50% deionized water.

μ PAD

A six-lane μ PAD was designed as a test bed to detect the following psychotropic compounds: cocaine, codeine, thebaine, amphetamine, ephedrine, morphine, ketamine, MDMA and methamphetamine (Figure 1). The device was prepared using a commercial wax printer (Xerox Color Cube 8750, Xerox, US), which was used to print the six-lane pattern on chromatographic paper Whatmann no.1 (GE Healthcare, UK). Next the paper was placed into an aluminum foil pouch and passed twice through a laminator at 160 °C, at a speed of 1.6 cm/sec (Tamerica Tashin Industrial Corp, TCC-6000) to melt the wax completely through the paper and create hydrophobic barriers.

Each lane was designed to detect a different set of compounds, with certain channels producing a variety of colored responses depending on the analyte present. Figure 1 illustrates the design of the device with numbers identifying each channel and letters showing the potential locations for the placement of each reagent. Samples and reagents were placed in different zones to optimize system stability and color generation. Lane 1 (L1 in Figure 1) was designed to detect ephedrine, MDMA and methamphetamine in unknown samples. In this lane, 0.5 μ L of an aqueous solution containing 100 mg/mL sodium sulphate and 10 mg/mL fast blue B were added to zone A. Lane 2 (L2 in Figure 1) was designed to detect four compounds: cocaine, codeine, thebaine and ketamine. Colorimetric detection was performed using a mixture of 300 μ L of 100 mg/mL cobalt thiocyanate and 200 μ L of glycerol. This reagent was added to L2 zone A (Figure 1). Lane 3 (L3 in Figure 1) was designed to detect codeine, MDMA, morphine and methamphetamine. By using the tip of a spatula, 1 mg of potassium permanganate was pressed onto lane 2 zone A, (Figure 1), and 2 μ L of 1 mg/ μ L molybdc acid were placed at L3 zone B (Figure 1). Lane 4 (L4 in Figure 1) was designed to detect

Ketamine by using 0.5 μL of a solution of 0.02 mg/mL sodium hydroxide in zone B of lane 5 and 0.5

$$A_X = -\log \frac{I_X - I_{X,b}}{I_{X,w} - I_{X,b}} = -\log \frac{(I_X)_c}{(I_{X,w})_c} = -\log R_X \quad (1)$$

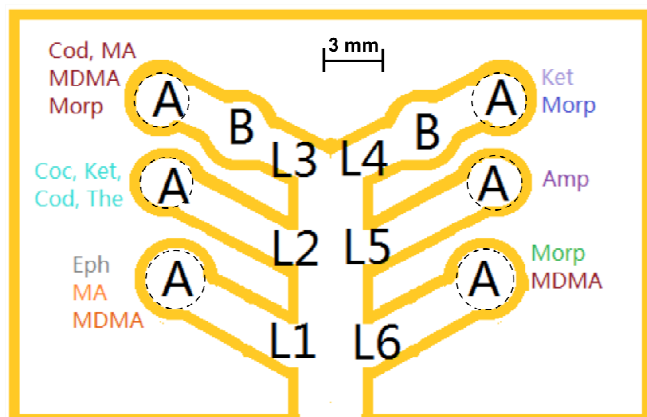

Figure 1: Six lane device developed for sample analysis. The device consists of 6 channels with one or two zones for placing reagents. The sample is dissolved in solvent and introduced at the bottom of the device using a paper tab placed in a vial. Capillary action mobilizes the drug and solvent mixture up into the reaction zones. Dashed areas indicate the image region used for colorimetric detection by eye or cell phone camera.

μL of 12.5 mg/mL cobalt thiocyanate in zone A. Lane 5 (L5 in Figure 1) was designed to detect amphetamine by depositing 0.5 μL of 50 mg/mL ninhydrin in 50% acetone/50% deionized water and a solution of NaOH 1 M in the same location (L5, zone A). Lane 6 (L6 in Figure 1) was designed to detect morphine and MDMA. In this lane 0.5 μL of 100 mg/ml FeCl_3 was added to L6 zone A. Finally, to operate the device the bottom tip is placed in a carrier solution of 300 μL of 50% acetone in water. Figure 2 provides an example of the operation of the device by demonstrating a positive result for a sample of morphine.

Estimation of MDQ

The calculation of MDQ was carried out using single and multi-lane devices. An 8 megapixel camera attached to a Nexus 5 (LGE) smartphone was used to record the images. In order to avoid external light contamination, the microfluidic devices were photographed on a white background, using the flash of the built-in smartphone camera as the light source, while maintaining a distance of 6 cm between the camera and the microfluidic device.

Data analysis was performed using ImageJ software version 1.48.¹⁷ The intensity of the Red, Green, Blue and RGB components was plotted as a function of quantity. In order to attain a direct proportionality, equation (1) was employed

in which A_X is the absorbance of X , I_X is the intensity of X , $I_{X,b} = 0$, $I_{X,w}$ was the intensity of the blank spot, and R_X is the reflectance of light X and C is the concentration of X .¹⁸

Estimation of MDQs were performed by using a slightly modified device which permitted the addition of each drug closer to the reagent area, Figure 3.

Testing was performed by depositing 0.5 μL of a variety of standard solutions containing 1 to 100 mg/mL of each drug to the sample area of each lane (A zones – Figure 3).

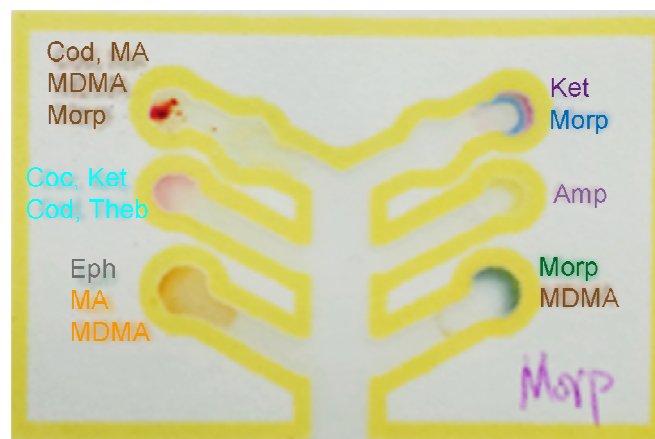
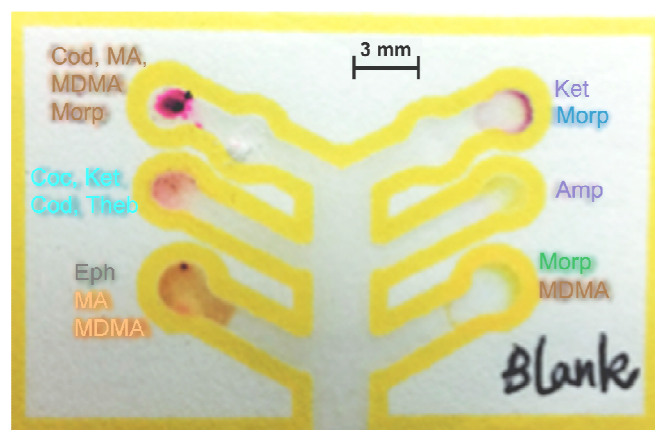

Figure 2: A demonstration of the μPAD developed to detect seized drugs: Top - Blank Sample; Bottom- a positive result for morphine. Each lane of the device is labeled with the name and color at which each analyte should appear. Lane 1 ephedrine (Eph), metamphetamine (MA) and MDMA; Lane 2 cocaine (Coc), codeine (Cod), ketamine (Ket) and thebaine (Theb); Lane 3 codeine (Cod), metamphetamine (MA), MDMA and morphine (Morp); Lane 4 ketamine (Ket) and morphine (Morp); Lane 5 amphetamine (Amp); Lane 6 morphine (Morp) and MDMA.

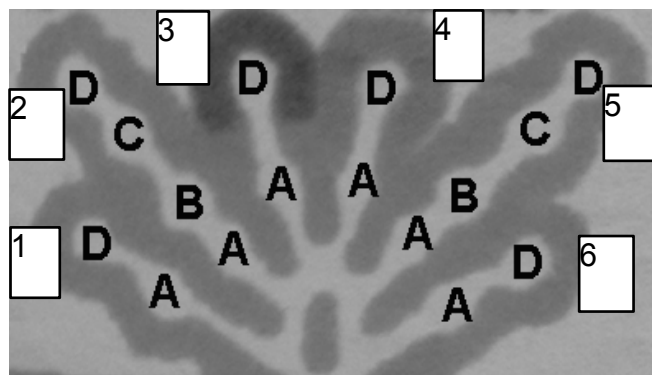

Figure 3: Multi assay presumptive test six lane device. Zone A: sample area; Zone B: middle part; Zone C: top part; Zone D: end part.

Each test was repeated three times. Quantitative measurements were performed at the end of each channel (zone A - Figure 1). To do this, the absorbance of each compound was measured as function of the quantity of the drug, and the minimum detectable quantity was estimated as three times the standard deviation of the intercept divided by the slope of the calibration line.

Results and discussion

The goal of this study was to prepare a multi-analyte μ PAD method for the presumptive determination of seized drugs. The procedure permits 6 simultaneous colorimetric tests to be performed, making the method highly specific, as interferences can be discriminated by their relative response in each colorimetric channel. Total analysis time was 5 minutes or less and only a few micrograms of sample were necessary to complete each test, Figure 2 illustrates the application of the test using morphine. Each separate channel is labeled with the drug target and the color expected for a positive result.

The various colorimetric tests used in each channel of the device were prepared by modifying previously known colorimetric tests for use with the paper microfluidic device. Critical design considerations in the optimization of the procedures were the replacement of any strong acids which might damage the paper and the separation of certain reagents into different areas of each channel to minimize reactivity when the device was not used. This procedure also enhances long term stability. Tests were selected for their specificity for a variety of commonly encountered illicit drugs including ketamine, cocaine, opiates such as codeine and various phenethyl amines (Table 1).

A common spot test for ketamine hydrochloride (Morris Reagent), involves basifying one drop of a solution of the unknown drug using one drop of 0.004 mg/mL NaOH. Next one drop of 0.02 mg/mL $\text{Co}(\text{SCN})_2$ is added producing a purple complex.¹⁶ In order to carry out the test on paper, 0.5 μL of 0.02 mg/mL NaOH was placed in zone B of lane 4 and 0.5 μL of 12.5 mg/mL $\text{Co}(\text{SCN})_2$ was placed in zone A, lane 4 (Figure 1). A sample of ketamine first reacts in the basic area and then the solution is carried over to the $\text{Co}(\text{SCN})_2$ reagent. Using this method, 11 μg of ketamine was sufficient to observe a color change (Table 1). The purple color produced was specific for ketamine, while the color change produced by other drugs was blue-green with exception of morphine (Table 1).

Table 1: Specificity of the reagents. The reagents were tested for: morphine, amphetamine, ketamine, ephedrine, thebaine, methamphetamine, codeine, MDMA and cocaine. R#1: Fast Blue B Reagent; R#2: FeCl_3 Reagent; R#3: Ninhydrin Reagent; R#4: Modified Scott's Reagent; R#5: Modified Morris Reagent; R#6: Modified Froehde's Reagent. NCC: no color change.

	R#1	R#2	R#3	R#4	R#5	R#6
Blank solution						
Amphetamine	NCC	NCC		NCC		NCC
MDMA			NCC	NCC		
Methamphetamine		NCC	NCC	NCC		
Cocaine	NCC	NCC	NCC			NCC
Codeine	NCC	NCC	NCC			
Ketamine		NCC	NCC			NCC
Ephedrine			NCC	NCC		NCC
Morphine	NCC		NCC	NCC		
Thebaine	NCC	NCC	NCC			NCC

Analytical Methods

ARTICLE

Table 2: Regression analysis and estimation of MDQs.

Drugs	Relationship	Linear Range, $\mu\text{g}/\mu\text{L}$	Regression equation	R^2	Instr. MDQ, μg	Visually MDQ, μg
<i>Morphine</i>	A _R and C	12.5 - 100	$y = (0.0053 \pm 0.0004) x + (0.0074 \pm 0.0057)$	0.9807	3.2	4.7
<i>MDMA</i>	A _B and C	25 - 100	$y = (0.0082 \pm 0.0009) x - (0.0219 \pm 0.0239)$	0.9630	8.7	11
<i>Amphetamine</i>	A _G and C	12.5 - 75	$y = (0.0069 \pm 0.0002) x + (0.0014 \pm 0.0029)$	0.9980	1.2	4.6
<i>MA</i>	A _B and C	12.5 - 50	$y = (0.0110 \pm 0.0013) x + (0.0280 \pm 0.0205)$	0.9576	5.6	6.2
<i>Ketamine</i>	A _{RGB} and C	25 - 75	$y = (0.0016 \pm 0.0001) x - (0.0053 \pm 0.0022)$	0.9766	4.1	11
<i>Ephedrine</i>	A _B and C	6.25 - 25	$y = (0.0144 \pm 0.0015) x - (0.0060 \pm 0.0116)$	0.9680	2.4	3.1
<i>Cocaine*</i>	A _R and C	6.25 - 25	$y = (0.0048 \pm 0.0005) x - (0.0040 \pm 0.0028)$	0.9730	1.4	2.5
<i>Codeine*</i>	A _B and C	6.25 - 25	$y = (0.0056 \pm 0.0006) x - (0.0040 \pm 0.0037)$	0.9698	2.0	2.7

*Non-specific identification. The modified Scott's Reagent was used for cocaine while the modified Froehde's Reagent was used for codeine.

ARTICLE

For the determination of amphetamine, methamphetamine and MDMA we initially examined a set of common color test reagents including the Mandelin, Marquis and Simon's reagents.⁴ Unfortunately, the Mandelin and Marquis reagents utilized a concentrated sulfuric acid of sufficient strength to digest paper. If the concentration of this acid is reduced, the tests are not effective. The Simon's Reagent was also not utilized as the high volatility of the acetaldehyde limited storage time¹⁹.

As an alternative to these reagents, we prepared a reagent based on fast blue B.¹⁵ The initial composition of the reagent involved a solution containing 10 mg/mL sodium sulfate and 0.1 mg/mL fast blue B. For the test, 0.5 μ L of the reagent was placed in lane 1 zone A (Figure 1) However, in order to obtain a visible color change on the paper device, the concentration of the two reagents had to be increased to 100 mg/mL for sodium sulphate and 10 mg/mL for fast blue B. Using this test, MDMA and methamphetamine produced an orange-red color, ketamine gave a yellow-orange color, and ephedrine produced a dark grey color. In addition, amphetamine and morphine were distinguishable from the blank, producing a weak brown color (Table 1).

In order to determine ephedrine (one of the main chemical precursors of methamphetamine¹), 6.2 μ g of the drug was necessary. A quantity of 5.1 μ g of MDMA and 6.2 μ g of methamphetamine, were sufficient to produce a color for these drugs (Table 2). The colors for ketamine, MDMA and methamphetamine were only slightly different. However, by combining the response of the fast blue B-based reagent, and the modified Morris reagent, the user can distinguish ketamine from MDMA and methamphetamine (Table 1).

A solution of FeCl_3 was also examined for its ability to distinguish target compounds by color. In order to obtain the best analytical conditions, a concentration range between 10 and 1000 mg/mL of FeCl_3 was investigated, by adding 0.5 μ L of the reagent to zone A of lane 6 (Figure 1). The optimum condition in terms of contrast between a blank sample and a morphine sample was observed at a concentration of 100 mg/mL of FeCl_3 . Using this test, a bluish-green color was observed for morphine, a brown color for MDMA and an orange color for ketamine (Table 1). Consequently the combination of the FeCl_3 result with that from fast blue B, permits the user to distinguish between MDMA and methamphetamine, further increasing the specificity of the μ PAD. The reagent FeCl_3 (0.5 μ L at 100 mg/mL)

was able to detect analyte quantities as low as 4.7 μ g of morphine and 11 μ g of MDMA (Table 2).

Ninhydrin hydrate was employed to detect primary amino groups.¹³ Initially a solution containing 50 mg/mL of ninhydrin in 50% acetone/50% deionized water was used, but the reaction was too slow with a color change observed only after 30 minutes. In order to develop a paper-based device capable of detecting amphetamine in under 5 minutes, the effect of pH on the reaction was investigated. The main reagent was a solution of 50 mg/mL ninhydrin in 50% acetone/50% deionized water. To test the effects of pH on this reagent, a three lane device was designed (Figure 4A). The test was performed by placing a 0.5 μ L of the ninhydrin reagent onto zones A, B and C of lanes 1, 2 and 3 (Figure 4A). Next 0.5 μ L of 0.5 M NaOH was placed in zone A and 0.5 μ L 3.7% HCl was placed in zone C (Figure 4A). When 0.5 μ L of a solution of amphetamine at 100 mg/mL was dropped on the A, B and C zones of this device, a color change was only observed in zone A (Figure 4C).

Next an examination of the effect of NaOH concentration was performed. A five lane device was designed to test the response to base concentration (Figure 4B). In this device 0.5 μ L of the ninhydrin reagent was placed in zone A, and 5 μ L of NaOH at concentrations of 1M, 2M, 3M, 4M and 5M, were also placed in zone A in lanes 1, 2, 3, 4 and 5 respectively. In the B zones of this device, 0.5 μ L of a solution of 100 mg/mL amphetamine was placed. The best result was observed using 0.5 μ L of 1 M NaOH (Figure 4D). Using this procedure a ninhydrin reagent specific for amphetamine was obtained. A minimum detectable quantity of 4.6 μ g of amphetamine was sufficient to produce a color change (Table 2), while no color change was observed for other drugs of abuse.

Lane 2 was prepared using a modified Scott Reagent.⁴ To obtain an observable color change on the paper, the best composition was 300 μ L of 100 mg/mL cobalt thiocyanate mixed with 200 μ L of glycerol; 0.5 μ L of the reagent were placed at the end of the lane (A zone of the lane 2 - Figure 1). With this reagent cocaine, codeine, ketamine and thebaine gave the same color change (blue-green), but this reagent was included on the μ PAD, because, it permits the user to distinguish between common powders and diluents used with psychotropic compounds (see next session). The resultant procedure was capable of detecting a minimum quantity of 1.4 μ g of cocaine (Table 3).

Froehde's reagent interacts with codeine and morphine, according an unknown reaction based on sequential mechanism, in which the analyte interacts with molybdic acid and then with sulfuric acid.⁴ Unfortunately it involves the use of sulfuric acid at sufficient concentration to digest paper, and decreasing the concentration of the acid for the test was not effective. Consequently the oxidizer agent used in this test, was replaced by KMnO_4 . Using the tip of a spatula 1 mg of KMnO_4 was placed at zone A of lane 3 and 2 μL of 1 mg/ μL molybdic acid at was placed in zone B of lane 3 (Figure 1).

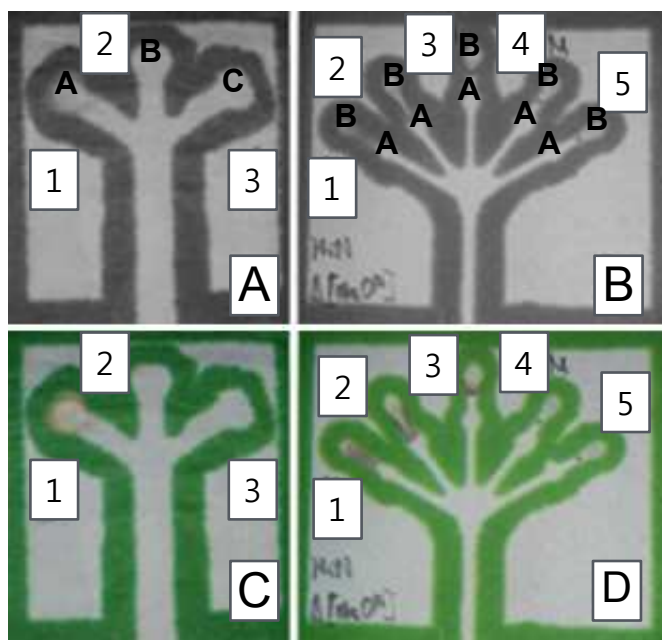

Figure 4: Development of the reagent utilized to detect amphetamine. A) and C) 0.5 μL of a solution of 50 mg/mL of ninhydrin was dropped in the A, B and C zones of the lanes 1, 2 and 3. In zone A of lane 1, 0.5 μL of NaOH 0.5 M was placed. In zone B of lane 2, 0.5 μL of HCl 3.7% was placed. Next 0.5 μL of 100mg/mL amphetamine was placed in the A, B and C zones of the lane 1, 2 and 3. B) and D) Next in zone A of each lane 0.5 μL of the ninhydrin reagent was placed. In addition in the 1, 2, 3, 4 and 5, 0.5 μL of NaOH 1 M, 2 M, 3 M, 4 M and 5 M were respectively placed. Finally 0.5 μL of amphetamine 100 mg/mL was placed in B zones of each lane.

Table 3: Comparison of MDQs calculated using the developed method and solution based presumptive tests reported in the literature⁴.

Drugs	Reagent	μPAD MDQ, μg	Reagent	Solution MDQ ⁴ , μg
Morphine	FeCl_3 R.	3.2	FeCl_3 R	200
MDMA	FeCl_3 R.	8.7	--	N/A
Amphetamine	Ninhydrin R.	1.2	Marquis R.	10
MA	Fast blue B R.	5.6	Marquis R.	5
Ketamine	Morris R.	4.1	Morris R.	1250
Ephedrine	Fast blue B R.	2.4	--	N/A
Cocaine*	Mod. Scott R.	1.4	Scott R.	60
Codeine*	Mod. Froehde R.	2.0	Froehde R.	50

*non-specific identification. The modified Scott's Reagent was used for cocaine, while the modified Froehde's Reagent was used for codeine

For this test, a blank solution gave a purple color, while codeine, morphine, MDMA and methamphetamine produced a color change from purple to brown (Table 1). As seen for the modified Scott reagent, the modified Froehde's reagent was not a specific reagent, however, it did not cause a color change following interaction with common powders and common diluents (see next section), *ergo* the modified Froehde's reagent constituted a valid procedure to distinguish drugs like MDMA, amphetamine, morphine and codeine from common powders and diluents. A quantity of 2 μg of codeine was sufficient to obtain a color change (Table 2).

The minimum quantity detectable (MDQ) for each drug of interest was calculated as the amount of drug necessary to produce a color change. The MDQ values were established by naked-eye (visually MDQ) and by processing the digital images (instrumental MDQ).

ARTICLE

Figure 5: Application of Image J software for the detection of various drugs on the μ PAD device. Pixel colors are indicated on the Y axis. Linearity ranges. a) Amphetamine; b) Ephedrine; c) MDMA; d) Ketamine; e) Morphine; f) Metamphetamine.

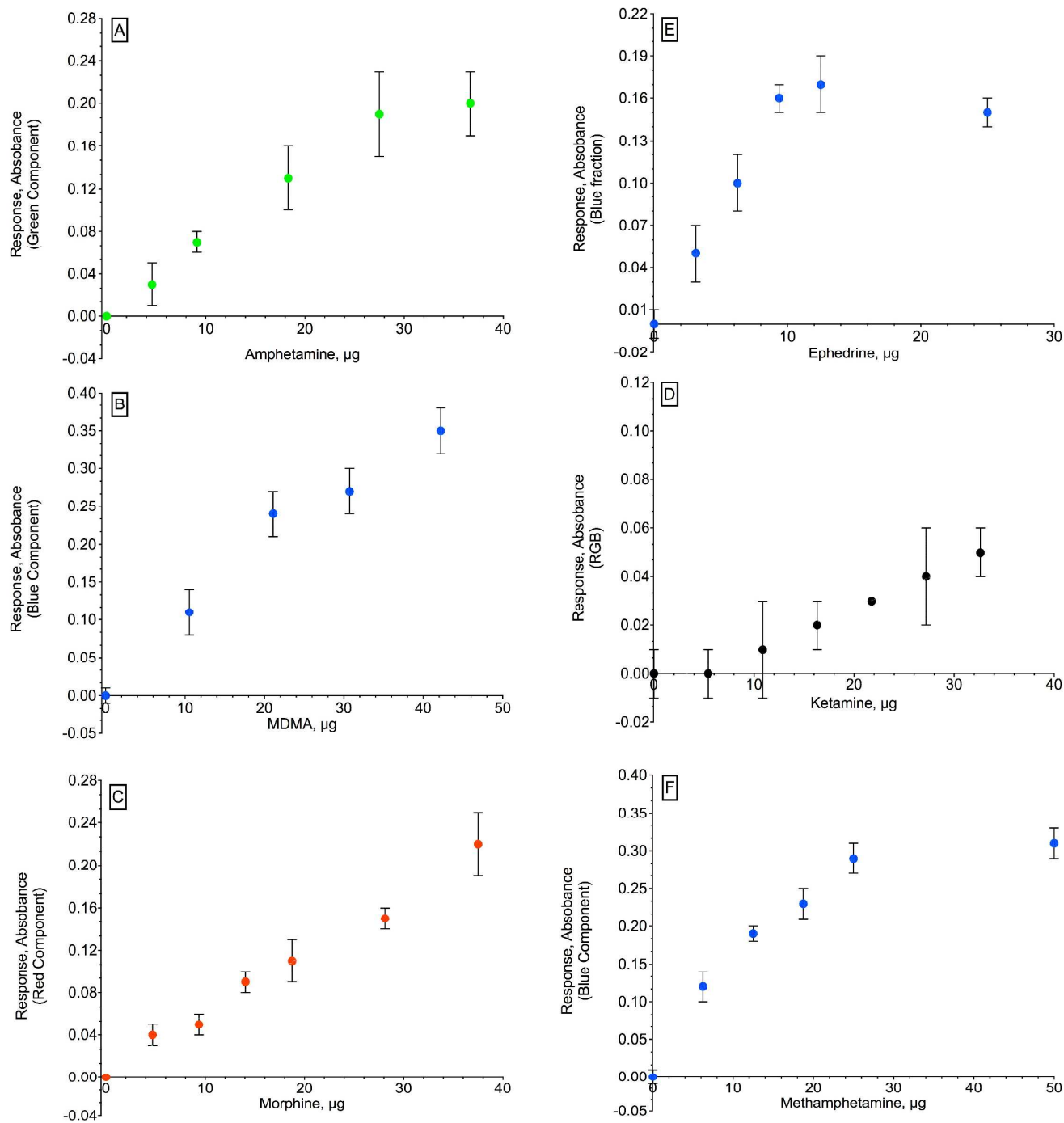

ARTICLE

For the compounds morphine, methamphetamine, MDMA, ephedrine, ketamine and amphetamine, the MDQs ranged from 1.2 to 8.7 μg depending on the drug analyzed, Table 2. Each test was repeated three times. The visual MDQs were estimated as the lowest amount of drug sufficient to produce a color change when compared to a blank sample. The instrumental MDQs were calculated using the free software ImageJ.¹⁷ The intensities of the components red, green, blue and RGB, of the area of reaction (end zone of the lanes – Figure 1), were extracted from each of the images obtained by smartphone. The results are plotted as a function of the quantity of drug, using equation (1), figure 5. Ephedrine, methamphetamine and MDMA showed the best linearity when using the absorbance of the blue component. The components green, RGB and red produced the best values for amphetamine, ketamine and morphine, respectively (Graph 1). The R squared values ranged from 0.9576 to 0.9980 (Table 2). The value of instrumental MDQs was estimated as three times the standard deviation of the intercept divided by the slope of the calibration curve. As a result of the regression analysis, the instrumental MDQs were slightly different from visual MDQs (Table 2). The resulting values were compared to the MDQs reported in literature.^{4,16} The MDQs of methamphetamine were similar, while for all other compounds, the sensitivity was enhanced; the MDQ was improved 10 times for amphetamine, over 60 times for morphine, 40 times for cocaine, 25 times for codeine and over 300 times for ketamine (Table 3).

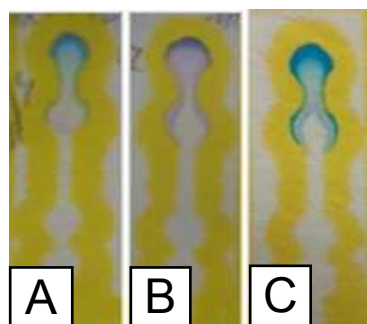

Figure 6: Detection of amphetamine, ketamine and a mixture of phenethyl amines. A) Amphetamine; B) ketamine; C) ketamine, amphetamine, methamphetamine and MDMA.

In order to evaluate the effects of interfering compounds on the color change, the target compounds were mixed with other drugs, common adulterants and common diluents. Typically, ketamine preparations are not adulterated²⁰, rather, ketamine is used as adulterant of amphetamine, methamphetamine and MDMA.²¹ The procedure was capable of detecting ketamine even when mixed with amphetamine, methamphetamine and MDMA. Since the colors were slightly different for the mixtures (Table 1), the final color of a mixture of ketamine, MDMA, amphetamine and methamphetamine didn't permit quantification (Figure 6).

The developed method was also able to detect MDMA and MA, when mixed with cutting agents. However it is important to note that samples of seized MDMA²² and seized MA¹, are most frequently encountered as powders at high purity. The μPAD test was capable of identifying amphetamine even when mixed with ketamine, methamphetamine and MDMA or mixed with common adulterant and diluent like lactose, sucrose, mannitol, caffeine and dimethylsulfone. The limit of detection was not affected by the presence of common interferences (Figure 7).

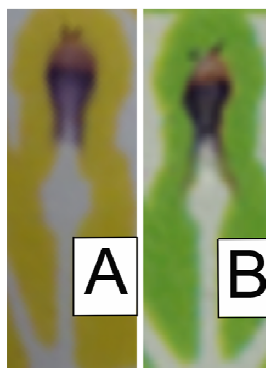

Figure 7. Detection of amphetamine mixed with various interferences A) 100 mg/mL amphetamine mixed with lactose, sucrose, mannitol, caffeine and dimethylsulfone at 100mg/mL; B) 100 mg/mL amphetamine.

False positives: common powder, diluents and adulterants

In order to test for interferences, nine commercial products including flour, baking soda, sugar, baking powder, bath salt, body powder, table salt, antacid and corn starch were tested to determine if false positive responses occur. Among the tested products, the baking

soda reacted with fast blue b reagent, showing a brown color. Most of the common diluents used to cut illicit compounds (quinine, lidocaine, procaine, caffeine, dimethylsulfone, lactose, sucrose, mannitol, and inositol didn't react with test reagents. However, procaine did produce a combination of colors close to that of methamphetamine (Table 4).

Table 4: False positives.

	R#1	R#2	R#3	R#4	R#5	R#6
Blank solution						
Positive solution						
<i>Common powder</i>						
King Arthur flour gluten free multipurpose	NCC	NCC	NCC	NCC	NCC	NCC
Arm&Hammer pure baking soda		NCC	NCC	NCC	NCC	NCC
Publix pure granulated sugar extra fine	NCC	NCC	NCC	NCC	NCC	NCC
Publix confectioner's sugar	NCC	NCC	NCC	NCC	NCC	NCC
Rumford aluminum free baking powder	NCC	NCC	NCC	NCC	NCC	NCC
Shower bath salt absorbent body powder	NCC	NCC	NCC	NCC	NCC	NCC
Winn Dixie iodized salt	NCC	NCC	NCC	NCC	NCC	NCC
Antacid tablet	NCC	NCC	NCC	NCC	NCC	NCC
<i>Adulterants</i>						
Quinine	NCC	NCC	NCC		NCC	NCC
Lidocaine	NCC	NCC	NCC	NCC	NCC	
Procaine		NCC	NCC			
Caffeine	NCC	NCC	NCC	NCC		NCC
<i>Diluents</i>						
Dimethyl sulfone	NCC	NCC	NCC	NCC	NCC	NCC
Lactose	NCC	NCC	NCC	NCC	NCC	NCC
Sucrose	NCC	NCC	NCC	NCC	NCC	NCC
Mannitol	NCC	NCC	NCC	NCC	NCC	NCC
Inositol	NCC	NCC	NCC	NCC	NCC	NCC
Starch	NCC	NCC	NCC	NCC	NCC	NCC

R#1: Fast Blue B Reagent; R#2: FeCl₃ Reagent; R#3: Ninhydrin Reagent; R#4: Modified Scott's Reagent; R#5: Modified Morris Reagent; R#6: Modified Froehde's Reagent.
NCC: no color change.

Stability

The stability of reagents absorbed on the paper was tested. All reagents maintained reactivity toward selected drugs for ten days, if stored at room temperature and without any kind of protection. In order to increase the stability of reagents on the paper, the laminator was utilized to plasticize the device. Sides of the device were covered utilizing plastic office sheets, edges of the paper were heated and the device was sealed. As a result of the sealant process, decomposition of reagents by means the oxidative action of atmospheric components was considerably decreased. This process increased the stability of reagents by at least a factor of three. Furthermore, non-coated devices were also usable for at least 30 days by keeping them away from light sources or storing them at 4° C.

Conclusions

A rapid and sensitive method using a paper microfluidic device has been developed for the presumptive determination of a variety of illicit seized drugs. The device, not much larger than a postage stamp, produces observable color changes that are detectable by the naked-eye that are sufficient to detect a few micrograms of compound, in under 5 minutes. The procedure uses low quantities of reagents in an easily stored format and demonstrates improved sensitivity when compared to solution based colorimetric testing. In addition, since the reagents are absorbed onto the paper the procedure is much easier to perform and less hazardous to use. The multichannel system permits the simultaneous detection of compounds using a variety different reagents. This process greatly increases the specificity of the method. The system also permits the user to distinguish between illicit drugs, drug diluents and common powders. Overall we expect this procedure to greatly benefit forensic testing, customs and other applications where quick portable testing of unknown powders is necessary.

Acknowledgements

Giacomo Musile is supported by a research grant awarded by the Italian Ministry of University and Scientific Research (FIRB2012 # RBFR12LD0W_003). The authors also gratefully acknowledge funding through NIJ grant 2013-DN-BX-K032. Points of view

1 in the document are those of the authors and do not
2 necessarily represent the official view of the U.S.
3 Department of Justice. G. Musile and L. Wang
4 contributed equally to the scholarship of this paper.
5
6
7
8
9
10

13 Notes and references

14 Corresponding Author
15 Bruce McCord

17 Author Locations:

19 ¹Department of Chemistry and Biochemistry
20 11200 SW 8th ST CP304
21 Florida International University
22 Miami, FL 33199
23 305-348-7543
24 mccordb@fiu.edu

26 ²Department Medicine/Public Health,
27 University of Verona
28 Policlinico G.B. Rossi, I-37134
29 Verona, Italy
30 045 8124618-045 8124246
31 franco.tagliaro@univr.it

- 33 1. UNODC, *World Drug Report*, 2014.
- 34 2. SWGDRUG, Recommendations Edition 7.0,
35 Accessed 2014-08-14.
- 36 3. C. D. Chin, V. Linder and S. K. Sia, *Lab on a chip*,
37 2007, **7**, 41-57.
- 38 4. C. L. O'Neal, D. J. Crouch and A. A. Fatah, *Forensic*
39 *Sci Int*, 2000, **109**, 189-201.
- 40 5. A. W. Martinez, S. T. Phillips, M. J. Butte and G. M.
41 Whitesides, *Angew Chem Int Ed Engl*, 2007, **46**,
42 1318-1320.
- 43 6. X. Li, J. Tian and W. Shen, *Anal Bioanal Chem*,
44 2010, **396**, 495-501.
- 45 7. A. W. Martinez, S. T. Phillips, Z. Nie, C. M. Cheng,
46 E. Carrilho, B. J. Wiley and G. M. Whitesides, *Lab*
47 *on a chip*, 2010, **10**, 2499-2504.
- 48 8. W. Dungchai, O. Chailapakul and C. S. Henry, *Anal*
49 *Chim Acta*, 2010, **674**, 227-233.
- 50 9. W. Dungchai, O. Chailapakul and C. S. Henry,
51 *Analyst*, 2011, **136**, 77-82.
- 52 10. C. Z. Li, K. Vandenberg, S. Prabhulkar, X. Zhu, L.
53 Schneper, K. Methee, C. J. Rosser and E. Almeida,
54 *Biosens Bioelectron*, 2011, **26**, 4342-4348.
- 55 11. K. L. Peters, I. Corbin, L. M. Kaufman, K. Zreibe, L.
56 Blanes and B. R. McCord, *Anal Methods-Uk*, 2015,
57 DOI: 10.1039/C4AY01677G.
- 58 12. A. W. Martinez, S. T. Phillips, E. Carrilho, S. W.
59 Thomas, 3rd, H. Sindi and G. M. Whitesides, *Anal*
60 *Chem*, 2008, **80**, 3699-3707.
13. M. Friedman, *J Agric Food Chem*, 2004, **52**, 385-
406.
14. R. S. o. Chemistry, S. o. P. Analysts, O. A.
Chemists, S. f. A. Chemistry, C. Society and S. o. P.
Analysts, *The Analyst*, Royal Society of Chemistry,
1888.
15. K.-A. Kovar and M. Laudszun, *Chemistry and*
Reaction Mechanisms of Rapid Tests for drugs of
abuse and precursors chemicals, UNODC, 1989.
16. J. A. Morris, *J Forensic Sci*, 2007, **52**, 84-87.
17. NIH, ImageJ, <http://imagej.nih.gov/ij/>.
18. M. Kompany-Zareh, M. Mansourian and F. Ravaee,
Analytica Chimica Acta, 2002, **471**, 97-104.
19. G. Nagy, I. Szöllősi and K. Szendrei, *Colour Tests*
for Precursor Chemicals of Amphetamine-Type
Substances The Use of Colour Tests for
Distinguishing between Ephedrine-Derivatives,
UNODC, 2005.
20. EMCDDA., *Lisbon: European Monitoring Centre on*
Drugs and Drug Addiction., 2000.
21. E. E. Tanner-Smith, *Drug Alcohol Depend*, 2006, **83**,
247-254.
22. EMCDDA, *European Drug Report: Trends and*
developments, 2014.