


 Cite this: *RSC Adv.*, 2023, **13**, 32940

# Recent advances in catalytic and non-catalytic epoxidation of terpenes: a pathway to bio-based polymers from waste biomass

 Mohamad Faiz Mukhtar Gunam Resul,<sup>ab</sup> Abdul Rehman,<sup>id</sup>\*<sup>ac</sup> Faisal Saleem,<sup>id</sup><sup>ac</sup> Muhammd Usman,<sup>id</sup><sup>c</sup> Ana María López Fernández,<sup>a</sup> Valentine C. Eze<sup>a</sup> and Adam P. Harvey<sup>a</sup>

Epoxides derived from waste biomass are a promising avenue for the production of bio-based polymers, including polyamides, polyesters, polyurethanes, and polycarbonates. This review article explores recent efforts to develop both catalytic and non-catalytic processes for the epoxidation of terpene, employing a variety of oxidizing agents and techniques for process intensification. Experimental investigations into the epoxidation of limonene have shown that these methods can be extended to other terpenes. To optimize the epoxidation of bio-based terpene, there is a need to develop continuous processes that address limitations in mass and heat transfer. This review discusses flow chemistry and innovative reactor designs as part of a multi-scale approach aimed at industrial transformation. These methods facilitate continuous processing, improve mixing, and either eliminate or reduce the need for solvents by enhancing heat transfer capabilities. Overall, the objective of this review is to contribute to the development of commercially viable processes for producing bio-based epoxides from waste biomass.

 Received 19th July 2023  
 Accepted 1st November 2023

DOI: 10.1039/d3ra04870e

[rsc.li/rsc-advances](https://rsc.li/rsc-advances)

## 1. Introduction

Terpenes are multifaceted compounds amenable to selective functionalization *via* epoxidation, thereby yielding a broad spectrum of molecules with diverse properties. Epoxides, characterized by their oxirane rings and high reactivity, hold a pivotal role in both the polymer industry and broader chemical synthesis. Traditionally, petrochemical-derived epoxides such as cyclohexene oxide, ethylene oxide, styrene oxide, and propylene oxide have been extensively employed in a range of industrial applications, including textiles, electronics, and packaging. However, there is an escalating demand for the development of alternative strategies that leverage waste biomass as a feedstock, aiming to mitigate environmental impact.<sup>1</sup>

Waste biomass serves as a renewable feedstock and presents a promising avenue for the production of bio-based polymers, including polyamides, polyesters, polyurethanes, and polycarbonates (Fig. 1). Lignocellulosic biomass, a major constituent of waste biomass, has garnered significant attention in this domain. Moreover, terpenes, a prevalent class of natural compounds, can be sourced from waste byproducts of forestry

and agricultural activities to produce unsaturated mono-terpenes. For instance, the pulp and paper industry generates  $\alpha$ - $\beta$ -pinene, while limonene is a byproduct of the citrus juice manufacturing sector.<sup>2</sup>

Among renewable monoterpenes, turpentine is particularly noteworthy as it is the most abundant byproduct of the Kraft paper pulping process, with the annual production of crude sulfate turpentine (CST) estimated at 230 000 tonnes. Additionally, the distillation of resin from forest plants yields approximately 100 000 tonnes of gum turpentine annually. These significant monoterpene feedstocks present an excellent opportunity for the development of efficient catalytic methods to convert them into versatile synthetic intermediates.<sup>3,4</sup> Enhancing the range of bio-renewable products generated by terpene biorefineries can improve the economic feasibility of these processes, while simultaneously reducing waste and overall carbon dioxide (CO<sub>2</sub>) emissions.<sup>3</sup>

Terpenes sourced from biomass, such as (*R*)-(+)-limonene and  $\alpha$ -pinene (as illustrated in Scheme 1), serve as valuable resources with wide applications in flavourings, fragrances, and pharmaceuticals.<sup>2,5-7</sup> Beyond these traditional uses, these terpenes can also be transformed through chemical synthesis into other beneficial compounds. The epoxidation of waste terpenes like limonene-1,2-epoxide and  $\alpha$ -pinene oxide offers an economically viable and environmentally sustainable approach for generating valuable intermediates for diverse industrial applications.<sup>8,9</sup> For example, limonene-1,2-epoxide has demonstrated its potential as a monomer in the synthesis of

<sup>a</sup>School of Engineering, Newcastle University, Newcastle upon Tyne NE1 7RU, UK

<sup>b</sup>Department of Chemical and Environmental Engineering, Faculty of Engineering, Universiti Putra Malaysia, 43400 UPM Serdang, Selangor, Malaysia

<sup>c</sup>Department of Chemical and Polymer Engineering, University of Engineering and Technology Lahore, Faisalabad Campus, Pakistan. E-mail: a.rehman2@uet.edu.pk

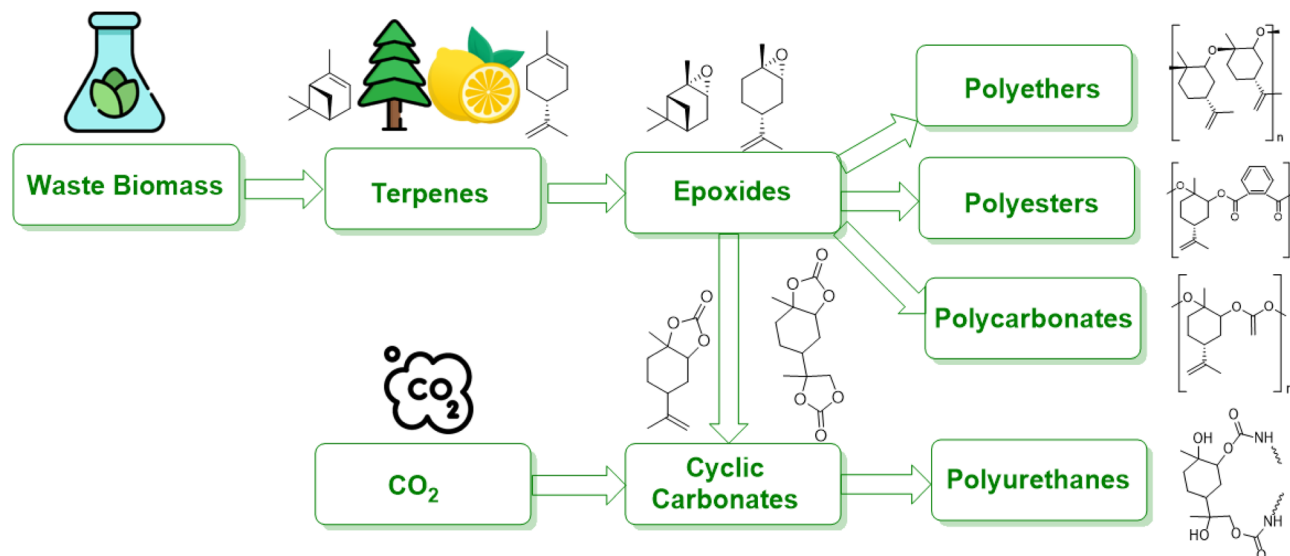
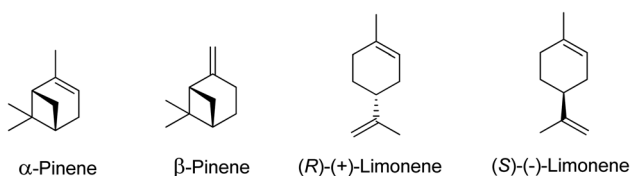



Fig. 1 Multiple routes to polymerize epoxides derived from biomass.



Scheme 1 Common monoterpenes found in turpentine oil.

limonene polycarbonate, while  $\alpha$ -pinene oxide can be isomerized to produce campholenic aldehyde, a key ingredient in the fragrance industry.<sup>4,10</sup>

Despite growing environmental concerns, current industrial methods for producing epoxides often rely on outdated techniques that use harmful chemicals, leading to issues of toxicity and stability. As a result, there has been an increasing focus on research into the epoxidation of (*R*)-(+)-limonene and  $\alpha$ -pinene using environmentally benign oxidants like hydrogen peroxide ( $\text{H}_2\text{O}_2$ ).<sup>11–21</sup> Recognized as the ‘greenest’ terminal oxidant, hydrogen peroxide generates only water ( $\text{H}_2\text{O}$ ) as a by-product,



Scheme 2 Epoxidation of terpenes with  $\text{H}_2\text{O}_2$ . (1) (*R*)-(+)-limonene, (2) *trans*-limonene-1,2-epoxide, (3)  $\alpha$ -pinene and (4) *trans*- $\alpha$ -pinene oxide.

as illustrated in Scheme 2. Consequently, the development of cleaner epoxidation methods, particularly those based on hydrogen peroxide, has become a significant area of research in recent years.

However, the use of  $\text{H}_2\text{O}_2$  for terpene epoxidation presents several challenges, including low selectivity due to the formation of multiple oxidative products, limited reaction rates arising from the biphasic nature of the reaction, and the immiscibility of hydrophobic terpenes with aqueous  $\text{H}_2\text{O}_2$ . Additionally, the highly exothermic nature of the reaction complicates heat removal.<sup>22–24</sup> To overcome these challenges, there is a pressing need to develop more efficient, environmentally friendly, and intensified processes that improve both mass and heat transfer. One promising avenue is the development of continuous processes, which can mitigate mass and heat transfer limitations. Flow chemistry and innovative reactor designs, such as the Oscillatory Baffled Reactor (OBR), offer a multi-scale approach for industrial applications. The OBR, a tubular reactor equipped with baffles, facilitates efficient multi-phase fluid mixing and heat removal by generating and dissipating vortices through the interaction between oscillating fluids and baffles. Employing catalysts like polyoxometalates can lead to the highly selective epoxidation of (*R*)-(+)-limonene and  $\alpha$ -pinene with  $\text{H}_2\text{O}_2$ .<sup>5</sup>

This review offers a comprehensive overview of recent developments in both catalytic and non-catalytic methods for terpene epoxidation, employing a variety of oxidizing agents and process intensification techniques. It also examines the generalizability of findings from limonene epoxidation studies to other terpenes. A key focus of this review is the need for continuous processes to overcome mass and heat transfer limitations inherent in bio-based terpene epoxidation. To this end, the review explores the utility of flow chemistry and innovative reactor designs, such as the Oscillatory Baffled Reactor, for achieving continuous processing, enhanced



mixing, and reduced solvent use. Ultimately, the review aims to contribute to the development of commercially viable processes for the production of bio-based epoxides from waste biomass. While there are existing reviews on the epoxidation of terpenes, such as the work published by Mahamat *et al.* (2021),<sup>6</sup> this review offers a unique perspective by focusing on the catalytic oxidative upgrades of renewable terpene olefins. This review provides a comprehensive analysis of the challenges in achieving high selectivity and yields, particularly in the context of complex reaction mixtures, the addition of organic solvents, and high concentrations of oxidants.

## 2. Waste biomass as a resource for bio-based polymers

Synthetic polymers are widely used in industries such as packaging, textiles, toys, and electronics, and in 2014, approximately 300 Mt of polymers produced globally were fossil fuel-derived.<sup>7</sup> However, the stocks of these feedstocks are declining despite an increase in demand, and environmental concerns have raised awareness of the raw materials used and the end-of-life options of these polymers.<sup>8</sup> While the literature does not provide a direct answer to the decrease in the production of fossil fuel-derived polymers, there are indications of a shift towards bio-based alternatives. For instance, Sheldon and Norton (2020) in “Green Chemistry and the Plastic Pollution Challenge: Towards a Circular Economy” discuss how substituting plastics derived from fossil resources with bio-based alternatives can reduce emissions of greenhouse gases.<sup>9</sup> Similarly, Vogli *et al.* (2020) in “Life Cycle Assessment and Energy Balance of a Novel Polyhydroxyalkanoates Production Process” compare the environmental impacts of bio-based polymers with fossil-based ones, suggesting a move towards more sustainable options.<sup>25</sup> To address these concerns and the diminishing supply of fossil fuels, alternative measures focusing on the development of renewable polymers are needed. The increasing interest in bio-based polymers has been fueled by recent developments in this field, and policy and legislation, such as the 2015 climate agreement by the United Nations, are supporting the growth of sustainable bio-based polymers.<sup>26</sup> Waste biomass is being used to develop sustainable bio-based polymers that can reduce waste and CO<sub>2</sub> emissions. Many chemicals can be produced from waste biomass, such as agricultural waste, forestry waste, waste CO<sub>2</sub>, and paper waste, which can be used as feedstocks for bio-based polymers. It should be noted that bio-based polymers can vary in their biodegradability; they can be categorized as either biodegradable (*e.g.*, starch, PHA) or non-biodegradable (*e.g.*, bio-based PP).<sup>14</sup>

Fig. 2 illustrates bio-based alternatives to petrochemicals for the manufacturing of polymers, such as poly (limonene carbonate) and vegetable oil-derived triglycerides.<sup>12</sup> Recent research has focused on using carbohydrates in various forms, such as starch, cellulose, glucose, and fructose, to synthesize molecules like lactide, furan dicarboxylic acid (FDCA), ethylene glycol, and ethylene, which can be converted to bio-based polymers like polylactide (PLA), poly(ethylene furanoate)

(PEF), bio-derived poly(ethylene terephthalate) (bio-PET), and bio-derived polyethylene (bio-PE). Terpenes, diacids, and levo-glucosone are some common platform chemicals used in this process, with terpenes being used as feedstock due to their abundance.<sup>13</sup>

### 2.1 Terpenes derived from waste biomass

Terpenes are hydrocarbons that occur naturally in plants, animals, and insects.<sup>14,15</sup> They can be used as bio-based feedstock to produce several valuable products. To reduce dependence on fossil-based feedstocks and minimize greenhouse gas emissions, scientists have sought viable plant-based routes. Terpenes derived from waste biomass have been gaining attention for their potential in the synthesis of fine chemicals and various applications.<sup>16</sup> The utilization of waste biomass for terpene extraction not only provides a sustainable method for chemical production but also adds value to underutilized plant-based wastes.<sup>17</sup> Modified terpenes that contain functional groups are known as terpenoids. Terpenes can be classified based on the number of isoprene units they contain, with the general formula (C<sub>5</sub>H<sub>8</sub>)<sub>*n*</sub>. Table 1 lists the classification of terpenes and provides examples for each class. The global pulping industry produces an estimated 3.5 × 10<sup>5</sup> tonnes of turpentine oil per year,<sup>18</sup> and this number is expected to rise with the current surge in the industry. Turpentine oil is produced per tonne of pulp in quantities ranging from 0.3–1.0 kg,<sup>19</sup> and the most commonly produced monoterpene is  $\alpha$ -pinene (~70%).<sup>20</sup> Limonene (~8.6%, 0.3 × 10<sup>5</sup> tonnes per annum) is obtained worldwide primarily from turpentine oil production.<sup>18</sup> The crude turpentine oil obtained from steam-distilling pine typically contains 75–85%  $\alpha$ -pinene, with the remaining percentages being 0–3%  $\beta$ -pinene and 5–15% limonene.<sup>21</sup> Lemon peels are one of the main sources of limonene, containing 90 wt% limonene.<sup>19</sup> Citrus fruit peels yield limonene in the steam extraction process, and orange peels and waste products from orange harvesting are the primary sources of limonene.<sup>22</sup> Bio-based polymer production can benefit from the abundance of  $\alpha$ -pinene and limonene available globally at low cost.<sup>23</sup> The agricultural and timber industries produce an estimated 330 000 tonnes of terpenes each year.

Low molecular weight terpenes, such as monoterpenes, are commonly used as fragrances due to their high volatility, while some of the heavier terpenes like rubbers find use in the latex industry. Natural rubbers, which are polyisoprenes, are the most abundant bio-based terpenes.<sup>14</sup> Despite having a common structural skeleton, plants produce structurally diverse monoterpenes<sup>24</sup> Scheme 3 illustrates the biosynthesis routes and skeletons of monoterpenes in plants.

Among the many uses of monoterpenes,  $\alpha$ -pinene and (*R*)-(+)-limonene find application in the pharmaceutical industry, as well as in flavours and fragrances.<sup>14,27</sup> Polyterpenes derived from these terpenes can also be used as polymers.<sup>2</sup> Turpentine oil, which mainly consists of  $\alpha$ -pinene (45–97%),  $\beta$ -pinene (0.5–28%), and other monoterpenes including (*R*)-(+)-limonene, is a major source of these monoterpenes.<sup>28</sup> Recently,  $\alpha$ -pinene has been extracted from waste biomass, specifically from wood pulp



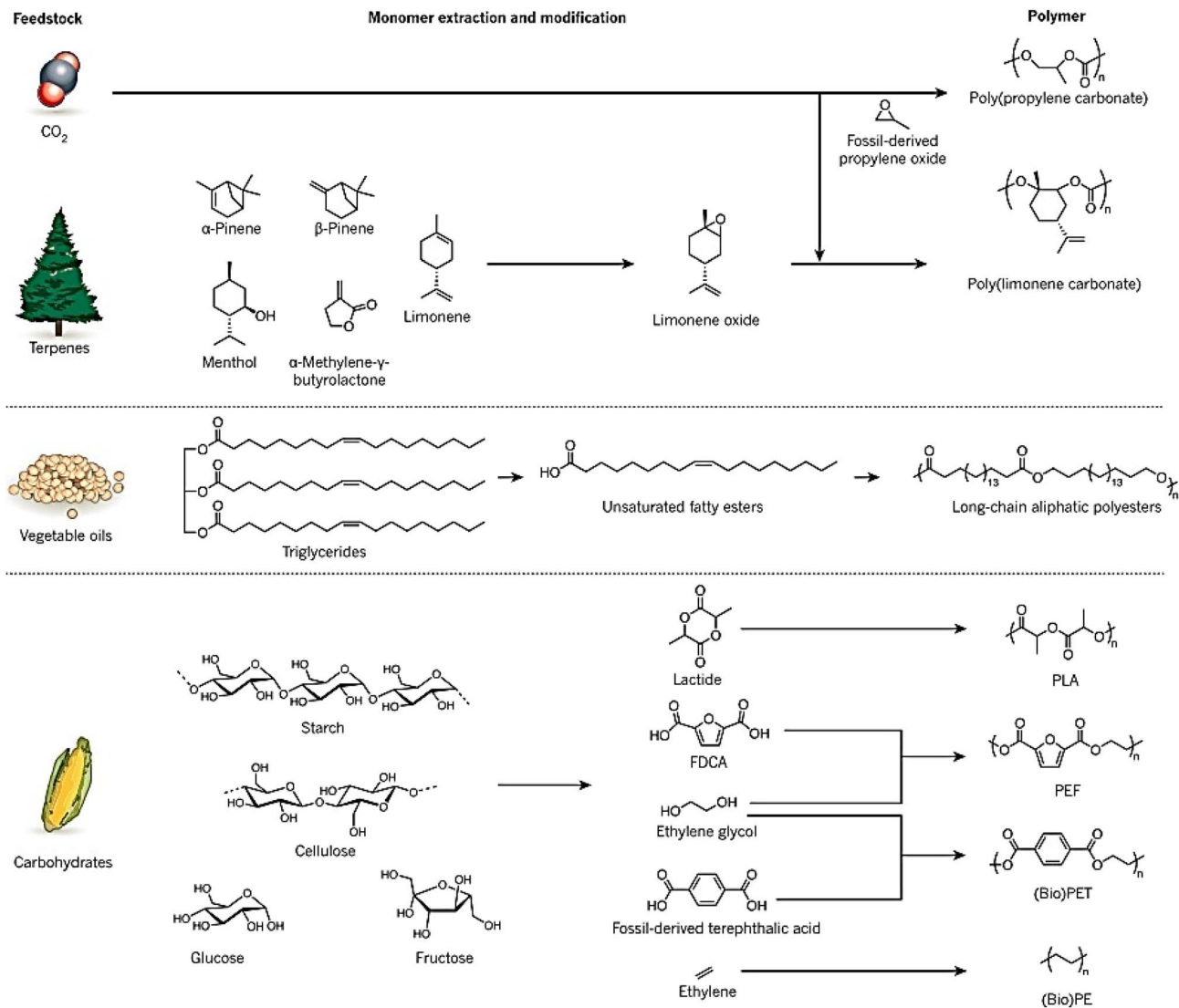


Fig. 2 Bio-based alternatives to petrochemicals for the manufacturing of polymers.<sup>1</sup>

processing, while (*R*)-(+)-limonene has been extracted from citrus peel waste.<sup>29</sup> Orange peel waste comprises 60% of the orange mass in the orange juice industry<sup>30</sup> and orange oil extracted from orange peel is up to 96 wt% (*R*)-(+)-limonene.<sup>31</sup> As a result, there is significant potential to convert this waste into valuable products such as bio-based polymers.<sup>32</sup> Furthermore, (*R*)-(+)-limonene can be converted into useful chemicals that find application as food, cosmetic, or pharmaceutical additives.

$\alpha$ -Pinene, another waste biomass-derived terpene, finds application in several flavours, fragrances, and pharmaceutical precursors.<sup>2,24,33–37</sup> Turpentine oil, a by-product of the wood and paper industries, is composed mainly of  $\alpha$ -pinene. Epoxidation of  $\alpha$ -pinene yields valuable products such as verbenol, verbenone, and  $\alpha$ -pinene oxide.<sup>38,39</sup>  $\alpha$ -Pinene oxide is an invaluable intermediate due to its many uses in various processes. It can be isomerized into products like campholenic aldehyde, which is useful in the production of sandalwood fragrances.<sup>5</sup>

## 3. Epoxidation of terpenes

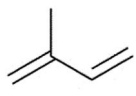
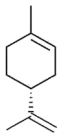
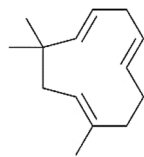
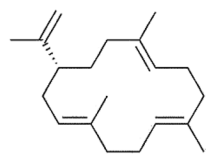
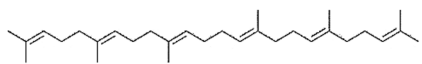
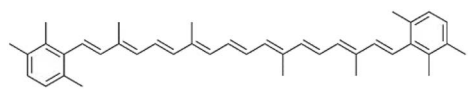
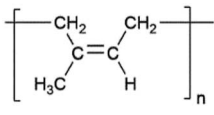
### 3.1 Introduction to epoxidation of terpenes

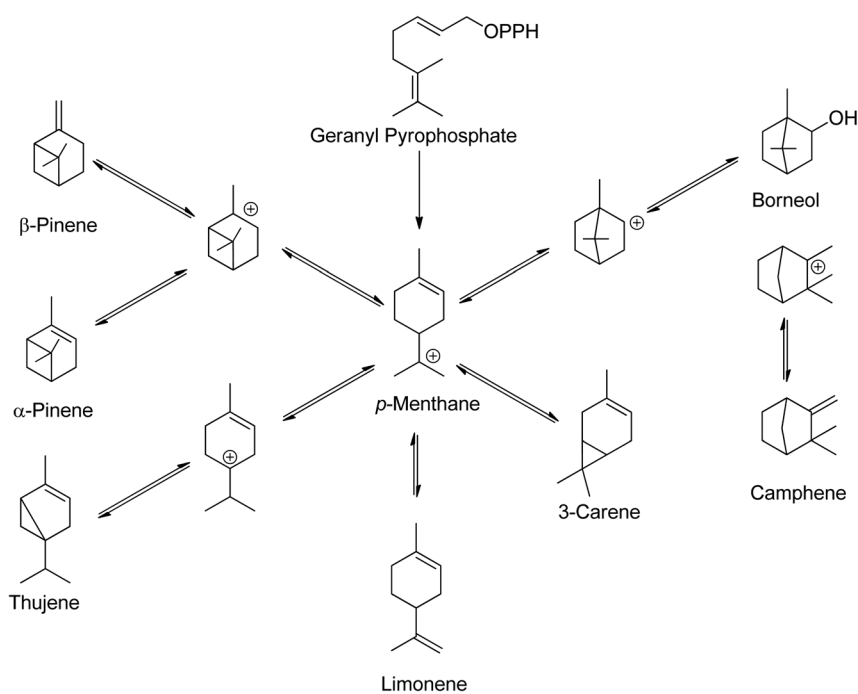
Epoxide is a highly reactive and versatile cyclic ether consisting of a three-membered ring. Due to their versatility, epoxides are suitable as intermediates in many chemical reactions,<sup>40</sup> and the polymer industry heavily relies on petrochemical-derived epoxides such as ethylene oxide, styrene oxide, and propylene oxide (Scheme 4), which as of 2014 had a combined estimated world production of 33 million tonnes/year.<sup>41</sup> However, concerns for environmental and sustainability issues have led to the emergence of possible alternatives to conventional epoxides using waste biomass and other non-petrochemical-based sources.<sup>1</sup>

Epoxides are used in various chemical processes such as the production of polyester, polyurethane, epoxy resins, glycols, alcohols, and carbonyl compounds. Long-chain alkenes like soybean oil are commercially epoxidised to produce plasticisers and stabilisers for PVC manufacturing.<sup>12</sup> There are several

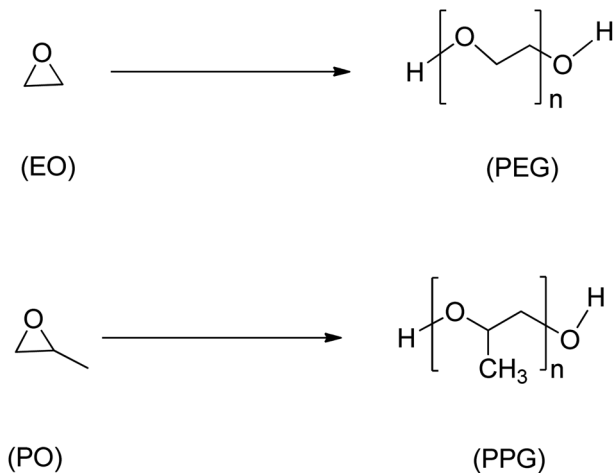


Table 1 Classification of terpenes and examples.<sup>14</sup>

Classification	General formula	Examples	Molecular structure
Hemiterpenes	C <sub>5</sub> H <sub>8</sub>	Isoprene	
Monoterpenes	C <sub>10</sub> H <sub>16</sub>	( <i>R</i> )-(+)-limonene	
Sesquiterpenes	C <sub>15</sub> H <sub>24</sub>	Humulene	
Diterpenes	C <sub>20</sub> H <sub>32</sub>	Cembrene	
Triterpenes	C <sub>30</sub> H <sub>48</sub>	Squalene	
Tetraterpenes	C <sub>40</sub> H <sub>64</sub>	Carotenoids	
Polyterpenes	>8 isoprene units	Rubber	

Scheme 3 In plants, monoterpenes have a common skeleton and biosynthetic route.<sup>24</sup>



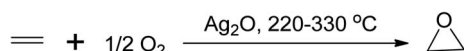


Scheme 4 Ethylene oxide (EO), propylene oxide (PO) and their respective polyethers, polyethylene glycol (PEG) and polypropylene glycol (PPG).

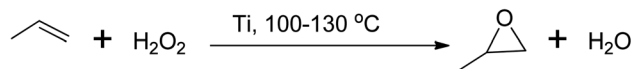
processes to produce epoxides, including the Prilezhaev route (using peracids as oxidants), Sharpless epoxidation (using organic hydroperoxides), Jacobsen-Katsuki epoxidation (using hypochlorites), Shi epoxidation (using dioxiranes), and the use of aqueous hydrogen peroxides ( $\text{H}_2\text{O}_2$ ),<sup>12</sup> with various starting materials commonly used such as alkenes, chlorocarbons, carbonyl compounds, epichlorohydrin, and substituted hydroxyls.<sup>42,43</sup> One of the conventional epoxidation processes involves the oxidation of ethylene to ethylene oxide, which occurs in the gaseous phase using a silver-based catalyst at temperatures between 220 and 330 °C,<sup>1</sup> as shown in Scheme 5.

Similarly, propylene oxide can be produced *via* several routes, with the peroxide-based process being used commercially at a temperature between 100 and 130 °C using either a molybdenum (Mo) or titanium (Ti) based catalyst,<sup>40,44</sup> as shown in Scheme 6. However, these hydroperoxide processes have limitations in terms of the formation of side products, and stoichiometric processes using peracids and catalytic processes using oxidants such as  $\text{O}_2$ , organic peroxides, and  $\text{H}_2\text{O}_2$  are more favourable.<sup>45</sup>

Mahamat *et al.* (2021)<sup>6</sup> emphasize the critical role of terpene epoxides as primary intermediates in the synthesis of various green polymers, including epoxy resins and non-isocyanate polyurethanes. They outline the efforts in developing both catalytic and non-catalytic processes for terpene epoxidation, primarily focusing on limonene. They highlight that epoxidation is a key process that needs to be adapted for natural products like terpenes, as it has been traditionally used to valorize fossil-origin compounds. It can be deduced that it is important to consider technical feasibility and scalability



Scheme 5 Epoxidation of ethylene to ethylene oxide with molecular oxygen using a silver catalyst.



Scheme 6 Peroxide-based epoxidation of propylene to corresponding propylene oxide using titanium catalyst.

alongside scientific understanding, highlighting the necessity of epoxidation processes that are both efficient and adaptable to a changing industrial landscape.

### 3.2 Oxidants used in terpene epoxidation

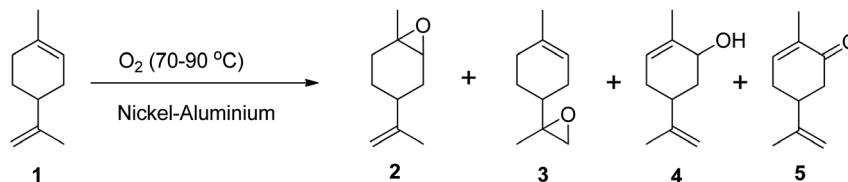
Epoxidation of alkenes can be achieved through three main routes: Prilezhaev, hydroperoxide, and catalytic routes. The Prilezhaev route typically uses peracids as oxidants, the hydroperoxide route uses organic peroxides such as *tert*-butyl hydrogen peroxide (TBHP), while the catalytic route usually employs molecular oxygen or  $\text{H}_2\text{O}_2$  as oxidants. The active oxygen from these oxidants is transferred to the double bonds, resulting in the formation of an epoxide.

**3.2.1 Oxygen ( $\text{O}_2$ ).** Catalytic epoxidation has become increasingly popular due to its advantages over peracids. Researchers have focused on developing a “green epoxidation process” using molecular oxygen, which is cheaper, easier to obtain, and produces fewer byproducts than other oxidants.<sup>46</sup> Commercial examples of this process include the epoxidation of ethylene and propylene to form their respective epoxides. However, the epoxidation of propylene and other alkenes using a heterogeneous silver catalyst is not possible due to the oxidation of allylic C–H bonds. The epoxidation of ethylene is the only example of an epoxidation process using a heterogeneous silver catalyst.

Molecular oxygen is a green oxidant that offers many advantages, but it also has some limitations. One of the limitations is that molecular oxygen is less reactive toward organic molecules at low temperatures and has less selectivity toward the main products due to the formation of radicals.<sup>47</sup> This can lead to the substrate being oxidized into many side products.<sup>47–49</sup> To address these limitations, Pena *et al.* (2012) used nickel-aluminium hydrotalcite as a catalyst to oxidize (*R*)-(+)-limonene in the liquid phase using molecular oxygen at temperatures between 70 and 90 °C under atmospheric pressure and in solvent-free conditions (Scheme 7).<sup>47</sup> They achieved a (*R*)-(+)-limonene conversion of up to 50%, producing many oxidative products including limonene-1,2-epoxide, limonene-8,9-epoxide, carveol, and carveone. However, they also found that the selectivity to epoxides was lower when using molecular oxygen due to the thermal decomposition of limonene hydroperoxides that initiate autooxidation.<sup>47</sup>

In a study on epoxidizing limonene with oxygen, Co/SBA-16 was created *via* post-grafting impregnation using a cobalt acetylacetonate solution. Isobutyraldehyde and ethyl acetate were used as green solvents, and the catalyst showed great activity under mild conditions.<sup>50</sup> The metal composition of the catalyst was found to affect epoxide selectivity, with  $\text{Co}^{2+}$  being more active than  $\text{Fe}^{2+}$ ,  $\text{Ni}^{2+}$ , and  $\text{Mn}^{2+}$ .  $\text{Co}^{2+}$  was found to catalyze chain initiation and branching of alkene epoxidation by  $\text{O}_2$  in



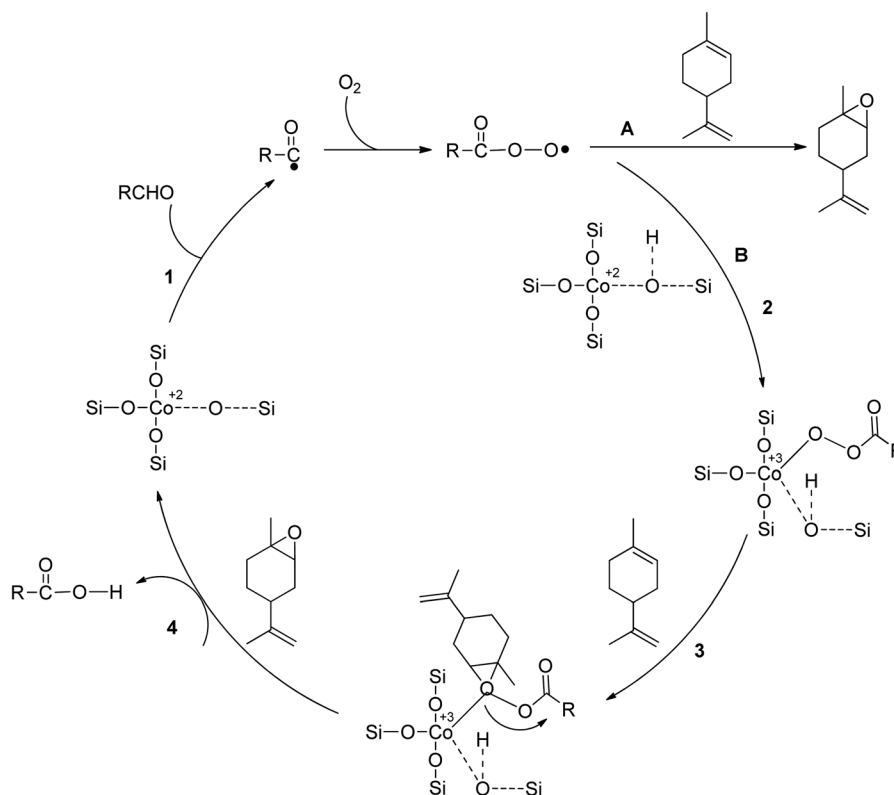


Scheme 7 Epoxidation of (1) (*R*)-(+)-limonene with molecular oxygen-producing (2) limonene-1,2-epoxide, (3) limonene-8,9-epoxide, (4) carveol and (5) carvone.

the presence of aldehydes, which activate dioxygen through coordination with the metal core. Scheme 8 shows a radical mechanism for epoxidizing limonene aerobically by an aldehyde catalyzed by SBA-16-supported  $\text{Co}^{2+}$ . The reaction between isobutyraldehyde ( $\text{RCHO}$ ) and molecular oxygen generates the acylperoxy radical, which acts as the primary epoxidizing agent. This species directly converts limonene to epoxide through pathway A or converts isolated  $\text{Co}^{2+}$  to Co-peroxy species through pathway B. Oxygen is transferred through the reaction between Co-peroxy and limonene in a concerted mechanism.

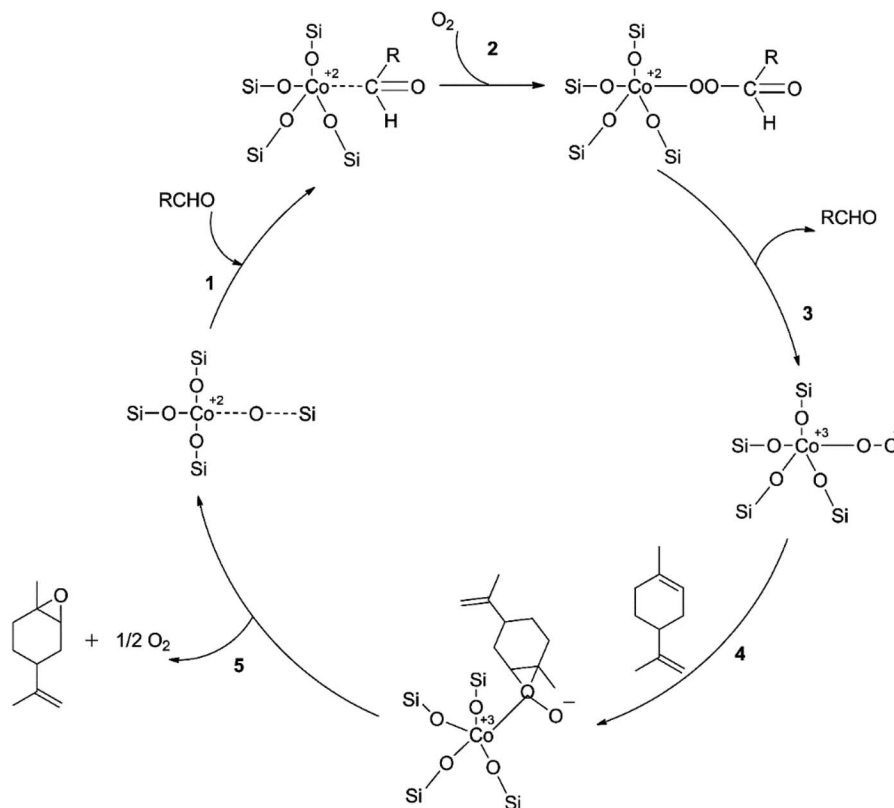
In a study using mesoporous silicon silica (SBA-16) grafted with cobalt, limonene was epoxidized aerobically using a new “pH-adjusting” technique.<sup>51</sup> The study examined various cobalt loadings to optimize Co/SBA-16’s catalytic performance. The results showed that Co/SBA-16 (1.1%) had the best-optimized epoxide yield (85%) and a lower cobalt loading than ideal Co/SBA-16 (4.5%) produced by post-grafting  $\text{Co}(\text{acac})_2$ .<sup>50</sup> This was because the cobalt precursor had not been introduced before

calcining the SBA-16 support, making  $\text{Co}^{2+}$  ions more accessible to silanol groups on the catalyst surface and increasing the density of tetrahedral  $\text{Co}^{2+}$  species. However, as cobalt loading increased, a decreasing trend in epoxide yield was observed, possibly due to equivalent oxidation facilitated by greater coordination of  $\text{Co}^{2+}$  ions at high cobalt loading.<sup>50</sup> Increasing the oxygen pressure from 15–44 psi resulted in the highest yield of limonene epoxides, followed by a decrease at a higher oxygen pressure of 58 psi, likely due to subsequent epoxide oxidation or ring-opening. The reaction mechanism was proposed based on a kinetic study under optimum reaction conditions, with the proposed pathway C employing the peroxy intermediate  $\text{Co}^{3+}\text{OO}^-$  in Scheme 9 being significant only at extremely low limonene concentrations due to the peculiar impact of a sharp decrease in the initial rate of limonene epoxidation rate at increasing limonene concentrations. Therefore, the method is not suitable for large-scale use.



Scheme 8 An aerobic limonene epoxidation method is proposed in the literature, reproduced from ref. 51.





Scheme 9 A proposed method for limonene aerobic epoxidation reproduced from ref. 50.

A study investigated the direct epoxidation of limonene using highly dispersed ruthenium (Ru) supported on activated carbon (AC) prepared by several immobilisation techniques, without the use of solvents.<sup>52</sup> The study found that in mild reaction conditions, Ru/AC showed excellent efficacy in the solvent-free epoxidation of limonene. Furthermore, the selectivity of the catalyst towards epoxidation was significantly impacted by the method of catalyst preparation. The cation exchange catalyst showed the greatest selectivity and yield of epoxidation products, despite having a lower conversion of limonene (40.4%) compared to the catalyst made using the sol-immobilization (SI) method. The oxidation of olefins with dioxygen can result in both epoxidation and allylic oxidation products. The ratio of allylic oxidation to epoxide products depends on the competition between alkyl peroxy radical incorporation and hydrogen removal. Limonene was found to be electrophilically attacked by ions leading to the formation of 1,2- and 8,9-epoxy limonene, the major epoxidation products, and 1,2,8,9-diepoxy limonene, a secondary epoxidation product. Allylic H-abstraction caused the formation of carveol and carveone. Scheme 10 depicts the two chemical routes that could be used to produce the main oxygenated byproducts.

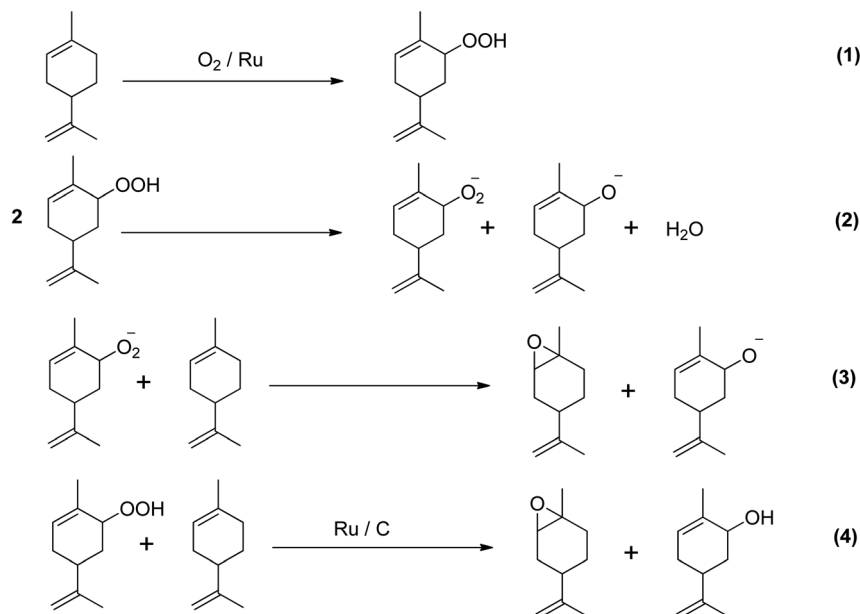
The study investigated two possible pathways for the epoxidation of limonene using ruthenium catalysts. The first pathway involves the activation of limonene and oxygen by ruthenium, leading to the formation of metal-alkene adducts on the catalyst surface. The second pathway is the autoxidation of limonene *via* a free radical chain mechanism, where the allylic

C-H bonds of limonene are activated to produce limonene hydroperoxide, which can then break down into epoxides and allylic products when reacting with oxygen. The study found that the ratio of epoxides to allylic oxidation products was higher, indicating a preference for the first pathway. Observations have been made on the epoxidation of  $\alpha$ -pinene using molecular oxygen. Patil *et al.* (2007) utilized a cobalt(II)-based heterogeneous catalyst in dimethylformamide (DMF) solvent, which resulted in a 47% conversion rate and 61% selectivity to  $\alpha$ -pinene oxide. However, the selectivity to epoxides was reduced due to a free radical mechanism.<sup>53</sup>

In contrast, Almeida *et al.* (2022) investigated green solvents such as organic carbonates for catalytic aerobic epoxidation of biodegradable alkenes.<sup>31</sup> Various catalysts were created using a conventional impregnation technique, including manganese, iron, and cobalt supported on alumina and silica. The cobalt catalyst supported by silica calcined at 550 °C produced significant results, producing a wide range of epoxides from biomass-based substrates with moderate to outstanding yields in mild reaction conditions. This method relies on the *in situ* production of active peroxy species from aldehydes and molecular oxygen using a non-noble metal catalyst, allowing for the basic limitations of conventional industrial techniques to be resolved. Moreover, dimethyl carbonate is highly recommended as a means of replacing undesirable solvents in industrial processes, as stated in current solvent sustainability guides. The reaction proceeds without any toxicity or reagent stability issues, resulting in the desired epoxide compounds.







Scheme 10 Proposed chemical route for solvent- and initiator-free aerobic limonene oxidation.<sup>31</sup>

Studies have recently focused on epoxidizing terpenes using the dimethyldioxirane (DMDO) epoxidation method. Ahmat *et al.* (2023) conducted a study on the DMDO-induced epoxidation of limonene and pinenes in microemulsions.<sup>54</sup> The study produced DMDO *in situ* in a microemulsion system to assess the efficacy of using the surfactant cetyltrimethylammonium hydrogen sulphate (CTAHS) to homogenize limonene and pinene in aqueous solutions. Using CTAHS offered significant benefits for the epoxidation process. Molar ratios of 1.6 and 0.9 of oxone/limonene and oxone/ $\alpha$ -pinene resulted in 100% yields of limonene bis-epoxide and  $\alpha$ -pinene oxide after 30 minutes. This method could be highly useful on an industrial scale. The main drawback of this method is the need to buffer the reaction mixture at a pH of 7–8 with sodium bicarbonate. Nonetheless, this approach has several advantages, including excellent selectivity for epoxides, no by-product formation, no solvent requirement in the aqueous medium, and no previous metal catalyst production. Acetone was employed in small amounts as a catalyst since it is easy to recycle and does not require deactivation like metal catalysts. Furthermore, this epoxidation method was carried out under ambient conditions as part of a green process.

**3.2.2 Hydrogen peroxide (H<sub>2</sub>O<sub>2</sub>).** In recent years, aqueous hydrogen peroxide (H<sub>2</sub>O<sub>2</sub>) has gained promising attention as a sustainable oxidant for alkene epoxidation.<sup>55–65</sup> The use of H<sub>2</sub>O<sub>2</sub> as an oxidant is advantageous as it produces only water, making it a green and eco-friendly process.<sup>66–68</sup> Studies on H<sub>2</sub>O<sub>2</sub>-mediated epoxidation have employed various catalysts containing metals such as molybdenum (Mo), rhenium (Re), titanium (Ti), and tungsten (W).

Michel *et al.* (2012) used methyltrioxorhenium (MTO) as a suitable catalyst for epoxidizing (*R*)-(+)-limonene with H<sub>2</sub>O<sub>2</sub> in dichloromethane (DCM) at 25 °C, showing a selectivity of 96% toward epoxide with a yield of 77% after 1 hour.<sup>63</sup> According to

their findings, the catalyst requires a pyridine-based compound to lower its acid centre and prevent diol formation. The catalyst exhibited enhanced selectivity toward limonene-1,2-epoxide and limonene bis-epoxides at lower and higher temperatures (>25 °C), respectively.

Cagnoli *et al.* (2005) demonstrated the epoxidation of (*R*)-(+)-limonene with H<sub>2</sub>O<sub>2</sub> using a titanium-based heterogeneous catalyst (Ti-MCM-41) in acetonitrile at 70 °C, reporting up to 60% conversion of (*R*)-(+)-limonene to several oxidative products, including limonene-1,2-epoxide, limonene bis-epoxide, limonene-1,2-diol, carveol, and carveone (Scheme 11).<sup>69</sup> The catalyst showed only 60% selectivity to the epoxide, but it had better activity than other titanium-based catalysts with minimal leaching.

Epoxidizing  $\alpha$ -pinene to  $\alpha$ -pinene oxide selectively using a metal catalyst is rarely reported in the literature. Cánepa *et al.* (2011) investigated the use of a titanium-based catalyst (Ti-MCM-41) in the epoxidation of  $\alpha$ -pinene with H<sub>2</sub>O<sub>2</sub> at 70 °C in acetonitrile. They found that the reaction showed reduced selectivity to  $\alpha$ -pinene oxide and was more selective to verbenone (41%), verbenol (16%), and campholenic aldehyde (27%), as shown in Scheme 12.<sup>60</sup> In a more recent study, Cánepa *et al.* (2015) used a heterogeneous vanadium-based catalyst to epoxidize  $\alpha$ -pinene with H<sub>2</sub>O<sub>2</sub> at 70 °C in acetonitrile. They observed a 91% conversion of H<sub>2</sub>O<sub>2</sub> (with  $\alpha$ -pinene in a higher molar ratio of 4 : 1) after 7 hours to yield several oxidative products, mainly verbenones (46%) but achieved less than 3% selectivity to  $\alpha$ -pinene oxide.<sup>70</sup>

Tungsten-based polyoxometalates are known as effective catalysts for epoxidation reactions using H<sub>2</sub>O<sub>2</sub> as the oxidant.<sup>71</sup> Jimtaisong and Luck (2006) compared the efficacy of molybdenum-based and tungsten-based catalysts for the epoxidation of cyclooctene using both TBHP and H<sub>2</sub>O<sub>2</sub>. They found that the tungsten-based catalyst was more active than the





**Scheme 11** Epoxidation of (1) (*R*)-(+)-limonene with Ti-MCM-41 producing (2) limonene-1,2-epoxide, (3) limonene bis-epoxide, (4) limonene-1,2-diol, (5) carveol and (6) carvone.

molybdenum-based catalyst when  $\text{H}_2\text{O}_2$  was used as an oxidant, but less active when TBHP was used.<sup>72</sup>

Ishii *et al.* (1988) and Venturello and D'Aloisio (1988) demonstrated efficient epoxidation of alkenes using tungsten-based polyoxometalates and  $\text{H}_2\text{O}_2$  in a biphasic environment containing quaternary ammonium salts as a phase transfer catalyst.<sup>73</sup> Venturello and D'Aloisio achieved up to 98% conversion of 1-dodecene with 96% selectivity to epoxides at 70 °C in 1,2-dichloroethane (Scheme 13),<sup>74</sup> while Ishii *et al.* achieved 96% conversion of cyclooctene at 98% selectivity to epoxides in chloroform.<sup>73</sup> However, both methods require chlorinated solvents, making them less environmentally friendly, so alternative approaches have been developed.

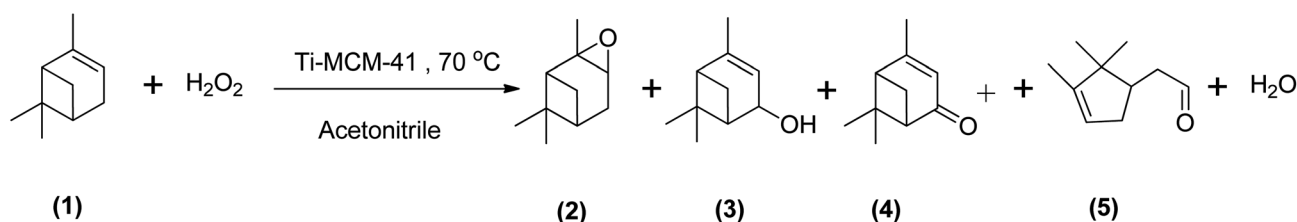
An improved method for the epoxidation of alkenes was developed using tungsten-based polyoxometalates in an organic solvent-free system, which employed aminomethylphosphonic acid ( $\text{NH}_2\text{CH}_2\text{PO}_3\text{H}_2$ ) and a halide-free quaternary ammonium hydrogensulfate ( $\text{Q}^+\text{HSO}_4^-$ ) as phase transfer catalyst, as depicted in Scheme 14.<sup>75</sup> This method significantly impacted further research on epoxidation reactions utilizing tungsten-based catalysts and  $\text{H}_2\text{O}_2$  as an oxidant, as the process was conducted in an environmentally friendly manner. However, the hydrolytic decomposition of acid-labile epoxides in acidic conditions was a drawback, and the acid used in this method was costly.

Grigoropoulou *et al.*<sup>76</sup> improved the 'Noyori' method for the epoxidation of (*R*)-(+)-limonene without using expensive aminomethylphosphonic acid. They achieved 94% conversion of (*R*)-(+)-limonene with 81% selectivity to limonene-1,2-epoxide by studying the epoxidation of (*R*)-(+)-limonene with  $\text{H}_2\text{O}_2$  using a sodium tungstate ( $\text{Na}_2\text{WO}_4$ ) catalyst at a temperature of 70 °C in organic solvent-free conditions. To increase the selectivity to epoxide and to prevent the ring-opening reaction in acidic conditions, they used an inorganic salt ( $\text{Na}_2\text{SO}_4$ ). Their findings had a substantial impact on the further development

of using  $\text{H}_2\text{O}_2$  as an oxidant for selective epoxidation. Hachiya *et al.* (2012) and Takumi *et al.* (2014)<sup>77</sup> also added inorganic salt to the solvent-free epoxidation of (*R*)-(+)-limonene with  $\text{H}_2\text{O}_2$  using a tungsten-based catalyst and produced a stable epoxide in acidic environments.<sup>78</sup> However, the effect of  $\text{Na}_2\text{SO}_4$  on the stability of epoxides requires further understanding and will be discussed in the relevant section (Section 4.6).

Maheswari *et al.* (2005) developed an improved version of the 'Noyori' method for the epoxidation of cyclooctene with  $\text{H}_2\text{O}_2$ . They used a tungsten-based ( $\text{Na}_2\text{WO}_4/\text{H}_2\text{WO}_4$ ) catalyst at 60 °C in a biphasic system without solvents. They added chloroacetic acids to mimic the effect of peracids, which resulted in a 90% conversion of cyclooctene at 99% selectivity to cyclooctene oxide. The residual acidity of the aqueous medium was crucial for the catalytic performance of the tungsten-based catalyst. The study found that acidity positively affects the epoxidation rate, but this approach may not be suitable for acid-labile epoxides such as terpenes oxide, as increasing acidity can lead to hydrolytic decomposition.<sup>79</sup> To address this, Kaur *et al.* (2010)<sup>80</sup> proposed a safer approach for the epoxidation of terpenes using solid urea hydrogen peroxide (UHP) with a tungsten-based catalytic system, which produced a yield comparable to conditioned aqueous  $\text{H}_2\text{O}_2$ -based epoxidations.

Although the authors cited above have reported methods for producing limonene-1,2-epoxide with high selectivity and minimal hydrolytic decomposition in recent years, the process has not been fully optimized, and the reaction kinetics remain unclear. Additionally, little attention has been given to conditions that promote the ring-opening of the epoxides. To address these issues, we utilized aqueous  $\text{H}_2\text{O}_2$  as an oxidant for the epoxidation of (*R*)-(+)-limonene and  $\alpha$ -pinene. This choice was made due to  $\text{H}_2\text{O}_2$ 's higher selectivity for epoxides and its environmentally friendly properties. We employed a tungsten-based polyoxometalates catalyst, which showed superior activity with  $\text{H}_2\text{O}_2$  compared to other catalysts. Section 3.8



**Scheme 12** Epoxidation of (1)  $\alpha$ -pinene with Ti-MCM-41 catalyst producing (2)  $\alpha$ -pinene oxide, (3) verbenol, (4) verbenone and (5) campholenic aldehyde.





Scheme 13 Epoxidation of 1-dodecene to 1,2-epoxydodecane using quaternary ammonium salt ( $Q^+X^-$ ) as phase transfer catalyst.

provides a further discussion of the chemistry, structure, and mechanism of the polyoxometalate catalyst. Many oxidative products can be generated by epoxidation of (*R*)-(+)-limonene with  $H_2O_2$  (oxidant). Scheme 15 shows products of (*R*)-(+)-limonene epoxidation, including their respective stereoisomers.

$H_2O_2$ -based epoxidation of (*R*)-(+)-limonene (1) with tungsten-based polyoxometalates yields both limonene-8,9-epoxide (2 and 3) and limonene-1,2-epoxide (4 and 5), which are a mixture of *cis*- and *trans*-isomers. Limonene-1,2-epoxide is the primary product due to the electrophilic nature of the oxidative species, which likely causes epoxidation at highly substituted double bonds.<sup>81</sup> To produce Limonene-bis-epoxide (6, 7, 8 and 9; a mixture of four stereoisomers), external double bonds of limonene-1,2-epoxide must be epoxidized. The hydrolytic decomposition of limonene-1,2-epoxide can also result in the formation of limonene-1,2-diol (10) facilitated by acid ( $H^+$ ) and  $H_2O$ . Additionally, allylic oxidation of (*R*)-(+)-limonene primarily produces carveol (11), which can be further oxidatively dehydrogenated to produce carvone (12).<sup>82</sup> The well-known  $H_2O_2$ -based epoxidation reaction of  $\alpha$ -pinene with a metal catalyst produces several oxidative products. Scheme 16 presents a simplified version of the reaction scheme.

The tungsten-based catalyst used in the epoxidation of  $\alpha$ -pinene (1) with  $H_2O_2$  primarily produces  $\alpha$ -pinene oxide (2) due to the electrophilic nature of the peroxo species, attracting substitution of  $\pi$  bonds.<sup>75</sup> The hydrolysis of  $\alpha$ -pinene oxide yields pinanediol (3) and sobrerol (5), assisted by  $H^+$  and  $H_2O$ .  $\alpha$ -Pinene oxide can also undergo rearrangement to form campholenic aldehyde (4) and allylic oxidation to produce verbenol (6), which can then be oxidatively dehydrogenated to form verbenone (7). The nature of the catalyst and radical formation determine whether epoxidation or allylic oxidation predominates.<sup>29</sup> Various hydroperoxides, including verbenyl hydroperoxides, can also be formed as intermediates using an active catalyst.<sup>83,84</sup> Research has shown that  $\alpha$ -pinene can isomerize during the oxidation process to produce several products, including  $\beta$ -pinene, (*R*)-(+)-limonene, terpineol, camphene, and 3-carene.<sup>85,86</sup> The rearrangement of  $\alpha$ -pinene oxide has produced many products, such as pinocarveol,

isopinocampone, and *trans*-carveol,<sup>10,87</sup> Additionally, oxidation can also lead to the formation of polymeric compounds, as shown in Scheme 17.

In recent work, a novel approach to rapidly and selectively epoxidize  $\alpha$ -pinene using  $H_2O_2$  in a single step without any solvent was reported.<sup>23</sup> Tungsten-based polyoxometalates were used as a catalyst to epoxidize  $\alpha$ -pinene with  $H_2O_2$ , and variables in the screening parameters included temperatures (30–70 °C), oxidant concentrations (100–200 mol%), acid concentrations (0.02–0.09 M), and solvent types (*e.g.*, *p*-cymene, toluene, acetonitrile, and 1,2-dichloroethane). Using process conditions of a 50 °C temperature, a solvent-free environment, and  $\alpha$ -pinene/ $H_2O_2$ /catalyst molar ratio of 5 : 1 : 0.01, almost 100% selective epoxidation of  $\alpha$ -pinene to  $\alpha$ -pinene oxide was achieved with negligible side product formation within a short processing time (20 min). 93% Conversion of  $H_2O_2$  with 100% selectivity to  $\alpha$ -pinene oxide was achieved using a single-step addition of the oxidant without a solvent. The study also demonstrated that allylic oxidation rates increased as oxidant concentrations increased. A kinetic study suggested that this reaction was first-order in terms of both the concentrations of the catalyst and  $\alpha$ -pinene, but fractional order (0.5) in terms of the concentration of  $H_2O_2$ . An activation energy of 35 kJ mol<sup>-1</sup> was required for the epoxidation reaction of  $\alpha$ -pinene. The key advantages of the described epoxidation procedure include the ability to perform the reaction at a constant temperature under a solvent-free environment to speed up the reaction rate and achieve selectivity to  $\alpha$ -pinene oxide of over 100%.

We recently reported a study on the synthesis of  $\alpha$ -pinane carbonate from  $\alpha$ -pinanediol.<sup>88</sup> This work represents the first example in the literature of producing  $\alpha$ -pinane carbonate from  $\alpha$ -pinanediol, which is a by-product of the most common monoterpene found in nature,  $\alpha$ -pinene. Prior attempts to make pinane carbonate by reacting  $\alpha$ -pinene epoxide with  $CO_2$  failed because the epoxide lacked reactivity in ring-opening polymerization due to steric hindrance. In this case, we combined  $\alpha$ -pinanediol and DMC to create  $\alpha$ -pinane carbonate under the influence of a TBD guanidine catalyst. The resulting white, crystalline solid known as  $\alpha$ -pinane carbonate had a melting point of 86 °C. After recrystallization, the highest yield of  $\alpha$ -pinane carbonate obtained was 81.1 ± 2.8%, with 98.7% purity.



Scheme 14 The epoxidation of cyclooctene with  $H_2O_2$  in a halide- and solvent-free system.





**Scheme 15** Products of (*R*)-(+)-limonene epoxidation with hydrogen peroxide ( $\text{H}_2\text{O}_2$ ) as oxidant in the presence of tungsten-based catalyst; (1) (*R*)-(+)-limonene, (2) *cis*-limonene-8,9-epoxide, (3) *trans*-limonene-8,9-epoxide, (4) *cis*-limonene-1,2-epoxide, (5) *trans*-limonene-1,2-epoxide, (6) RSS limonene bis-epoxide, (7) SRS limonene bis-epoxide, (8) RSR limonene bis-epoxide, (9) SRR limonene bis-epoxide, (10) *trans*-limonene-1,2-diol, (11) carveol and (12) carvone.



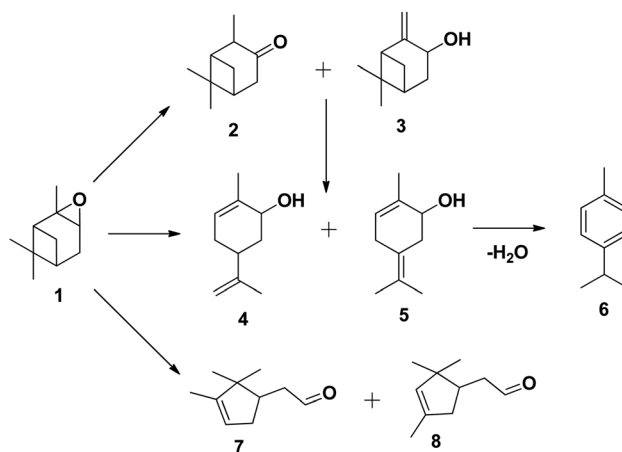
**Scheme 16** Product of  $\alpha$ -pinene epoxidation with hydrogen peroxide ( $\text{H}_2\text{O}_2$ ) as an oxidant in the presence of a tungsten-based catalyst; (1)  $\alpha$ -pinene, (2)  $\alpha$ -pinene oxide, (3) pinanediol, (4) campholenic aldehyde, (5) sobrerol, (6) verbenol and (7) verbenone.

We used several techniques, including FTIR, NMR, GC, GCMS, and QTOF mass spectrometers, to characterise the produced  $\alpha$ -pinane carbonate.

To establish a feasible process for potential resource recovery of the  $\alpha$ -pinanediol starting material, we examined the reactivity of the  $\alpha$ -pinane carbonate for base hydrolysis using NaOH in ethanol/water. The saponification of  $\alpha$ -pinane into  $\alpha$ -pinanediol and sodium carbonate was completed in less than 30 minutes. At an industrial scale, the  $\alpha$ -pinane carbonate can potentially be polymerized to produce poly( $\alpha$ -pinane carbonate), which is a bio-based thermoplastic, like poly(limonene carbonates). To recycle the initial feedstock for  $\alpha$ -pinanediol, the used poly( $\alpha$ -pinane carbonate) might be hydrolyzed in the same manner as the  $\alpha$ -pinane carbonate monomer.

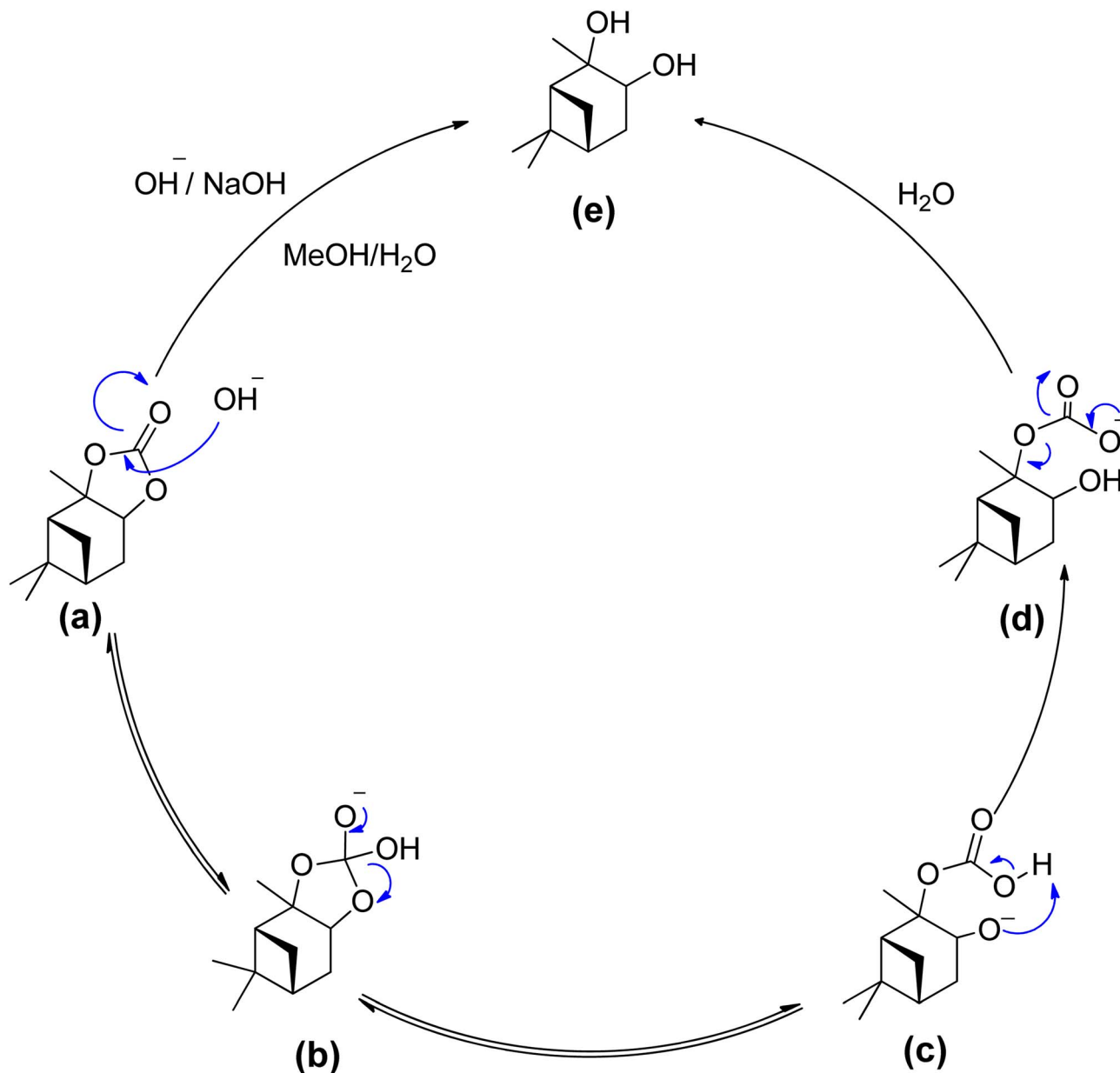
The hydrolysis of alkyl esters has been reported previously. The reaction mechanism for the hydrolysis of  $\alpha$ -pinane

carbonate is illustrated in Scheme 18.<sup>88</sup> A rate-determining step involves the bimolecular collision of the  $\alpha$ -pinane carbonate and hydroxide ion to create a tetrahedral intermediate, which decomposes to give the products.<sup>89</sup> For intermediate stabilization, a molecule of water is required, but the same job can be performed using a protic solvent like simple alcohols, which are the product of alkyl esters hydrolyzed with a base.<sup>89,90</sup> The hydroxyl group acts as a nucleophile during the reaction as illustrated in Scheme 18, reacting with  $\alpha$ -pinane carbonate (a) to produce intermediate (b), which disintegrates and thus the carbonyl group reforms to form 2-carboxylate-3-pinanol (d) using intermediate (c) in the basic ethanol/water solution, which further rearranges to provide final product (e). The hydroxyl group most likely attacks on the opposite side in the most electropositive position since one side of  $\alpha$ -pinane carbonate is more crowded, but further investigation is still required to establish the precise mechanism of the reaction.



**Scheme 17** Products of isomerisation of  $\alpha$ -pinene oxide; (1)  $\alpha$ -pinene oxide, (2) isopinocampone, (3) pinocarveol, (4) *trans*-carveol, (5) 2-methyl-5-(propan-2-ylidene) cyclohex-2-enol, (6) *p*-cymene, (7) campholenic aldehyde and (8) fencholenic aldehydes.<sup>10</sup>





Scheme 18 Proposed reaction mechanism - a bimolecular collision of solvated hydroxide ion with the alky esters carbonyl carbon.<sup>88</sup>

### 3.2.3 Other oxidants

**3.2.3.1 Prilezhaev epoxidation.** The prilezhaev epoxidation of alkenes is typically achieved using peracids as oxidants. Prileschajew (1909)<sup>91</sup> first demonstrated this method, which has since become widely accepted as the most common technique for synthesizing epoxides. Commonly used peracids include peroxyacetic acid, hydroxybenzoic acid, peroxyformic acid, *m*-chloroperoxybenzoic, and *p*-nitroperoxybenzoic (Scheme 19), due to their relative availability, lower cost, the stoichiometric yield of epoxides, and stability at mild temperatures.<sup>12</sup>

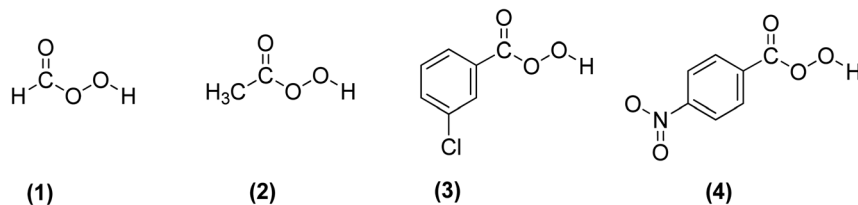
Peracids offer the flexibility of reaction medium, as they can be used in aqueous, organic, heterogeneous, and homogeneous media. However, they are hazardous due to the generation of

acid waste. The reaction scheme and mechanism of the epoxidation of alkene using peracid are shown in Scheme 20.

There are two methods for performing epoxidation using peracids: preformed peracid epoxidation and *in situ* peracid epoxidation. In both methods, aqueous  $\text{H}_2\text{O}_2$  is reacted with carboxylic acid over an acidic catalyst (*e.g.*,  $\text{H}_2\text{SO}_4$ ) to form a peracid.<sup>92</sup> Preformed peracids require rigorous storage procedures to minimize the risk of explosions due to exothermic decomposition. *In situ* peracids are favoured because they require minimal amounts of reactants to generate the oxidative species in the reaction, making the process much safer. The oxidative species are normally generated using a mineral acid as a catalyst, such as  $\text{H}_2\text{SO}_4$ . Alternatively, a heterogeneous catalyst such as an ion-exchange resin (IER)







**Scheme 19** Commonly used peracids for epoxidation; (1) peroxyformic acid, (2) peroxyacetic acid, (3) *m*-chloroperoxybenzoic and (4) *p*-nitroperoxybenzoic.

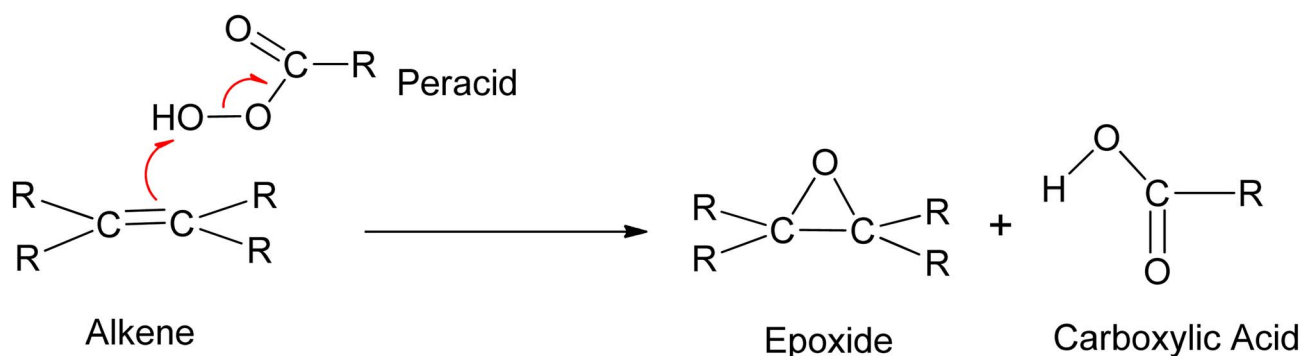
could be used to overcome separation and purification issues usually associated with homogeneous catalysts. The recyclability and selectivity of heterogeneous IERs for *in situ* peracids are better than for preformed peracids for the epoxidation of undecylinic acid.<sup>12</sup>

Researchers have been seeking an alternative to the peracid epoxidation method that is selective, safe, and “clean” as peracids produce significant amounts of acid waste, which poses safety and environmental issues. Goud *et al.* (2017) compared the performance of two types of peracids formed *in situ*, peroxyacetic acid and peroxyformic acid, for the epoxidation of jatropha oil using IER (Amberlite IR-120) as a catalyst at a temperature of up to 70 °C. They investigated the performance of the peracids with and without the presence of solvent (toluene) and found that the efficiency of peroxyformic acid in the *in situ* epoxidation of peracid is higher than peroxyacetic acid at temperatures below 80 °C. However, at temperatures above 80 °C, peroxyacetic acid was as effective as peroxyformic acid. Peracids have also been shown to be unsuitable for acid-sensitive epoxides, such as terpene oxide, as they cause severe hydrolysis of the epoxides.<sup>93</sup>

The peracetic acid route, which uses peracetic acids, such as *m*-chloroperoxybenzoic acid, as an oxidant, is one of the most common industrial epoxidation methods.<sup>42</sup> These chemicals produce significant amounts of acid waste, which poses safety and environmental issues.<sup>92,94</sup> Peracids have also been shown to be unsuitable for acid-sensitive epoxides, such as terpene oxide, as they cause severe hydrolysis of the epoxides.<sup>76</sup> As a result, researchers have been seeking an alternative to the peracid epoxidation method that is selective, safe, and “clean”.

**3.2.3.2 Hydroperoxide routes.** The epoxidation of alkenes using hydroperoxides, such as cumene hydroperoxides (CHP), ethylbenzene hydroperoxides (EBHP) and *tert*-butyl hydroperoxides (TBHP), is a better alternative to peracids as they are easier to handle and less hazardous for industrial epoxidation.<sup>95</sup> Hydroperoxides are significantly superior to H<sub>2</sub>O<sub>2</sub>, as they are soluble in hydrocarbons, while the dissolution of hydrogen peroxide is only possible in polar solvents. Organic peroxides have also been successfully used for the epoxidation of acid-labile epoxides, resulting in a better yield than peracids.<sup>12,42</sup> Balula and Bruno studied the epoxidation of (*R*)-(+)-limonene with TBHP and reported a 99% conversion with 100% selectivity, highlighting the advantage of using organic hydroperoxides.<sup>75</sup> Chiker *et al.* showed that when supported titanium is employed as the catalyst, TBHP is significantly more selective towards epoxides than H<sub>2</sub>O<sub>2</sub>.<sup>55</sup>

Studies have also focused on developing a heterogeneous catalyst for epoxidation using organic peroxides as oxidants. Charbonneau and Kaliaguine reported the epoxidation of (*R*)-(+)-limonene with TBHP using a titanium-based heterogeneous catalyst at a temperature of 75 °C in acetonitrile.<sup>81</sup> They reported an (*R*)-(+)-limonene conversion of 80% at 79% selectivity to limonene-1,2-epoxide. The reaction parameters, such as temperature, TBHP concentration, and solvent polarity, have been optimized. Solvents with higher polarity facilitate a higher activity for the epoxidation reaction with TBHP compared to solvents with lower polarity. Very little progress was made while utilizing TBHP to increase transformation to limonene bis-epoxide above Ti/SBA-16 catalytical system.<sup>96</sup> Recent research by Cunningham *et al.* produced a comparable outcome using



**Scheme 20** The reaction scheme and mechanism of the epoxidation of alkene using peracid.



H<sub>2</sub>O<sub>2</sub> as the oxidizing agent in an attempt to epoxidize limonene.<sup>97</sup>

Using TBHP as an oxidant produces radicals during the epoxidation reaction that are the same as observed for the epoxidation of  $\alpha$ -pinene using other similar kinds of oxidants. Becerra *et al.* demonstrated the epoxidation of  $\alpha$ -pinene with TBHP by applying an iron-based heterogeneous catalyst at a temperature of 50 °C in acetone. They obtained an  $\alpha$ -pinene conversion of 83% after 23 hours to many oxidative products, mainly verbenone. Their study concluded that under both catalytic and non-catalytic conditions, TBHP decomposes to form radicals that promote allylic oxidation of  $\alpha$ -pinene (Scheme 21).<sup>29</sup>

The use of organic peroxides, such as TBHP, generates organic by-products that require additional separation processes. For instance, in the presence of TBHP, (*R*)-(+)-limonene and  $\alpha$ -pinene epoxide produce *tert*-butanol, which necessitates the further separation of the alcohol from the epoxide products.<sup>98</sup> In this regard, a greener and more selective oxidant is required to develop a selective epoxidation process for (*R*)-(+)-limonene and  $\alpha$ -pinene.

### 3.3 Strategies to enhance reaction efficiency

**3.3.1 Catalyst.** Polyoxometalates (POMs) are versatile compounds that have been used in catalysis due to their wide variety of structures, which can incorporate many elements from the periodic table.<sup>99,100</sup> POMs are composed of transition metals in the highest oxidation state from oxo-anionic clusters through the dissolution of metal ions in an aqueous solution.<sup>101</sup> The acidity of the proton centre is related to the metal ion charge, and the structure and stability of the complex depend largely on the pH of the solution. POMs with transition metal substitutions have gained a lot of interest due to their oxidatively stable catalysts. Heteropolyanions are formed by the fusion of an anion at the centre of the complex in acidic conditions, and numerous anions can be fused. Heteropolyacids are formed when solid POM is composed of heteropolyanions, hydration water, and protons as counter-ions. A commonly used POM/HPA species, H<sub>3</sub>PW<sub>12</sub>O<sub>40</sub>, is a superacid used in many catalysis processes such as alkylation, acylation, and oxidation. The redox mechanism of POM in oxidation reactions can be used with either di-oxygen (O<sub>2</sub>) or hydrogen peroxide (H<sub>2</sub>O<sub>2</sub>) as oxidants. The use of POM in epoxidation has been investigated, and W-based POM was found to be the most effective with H<sub>2</sub>O<sub>2</sub>.

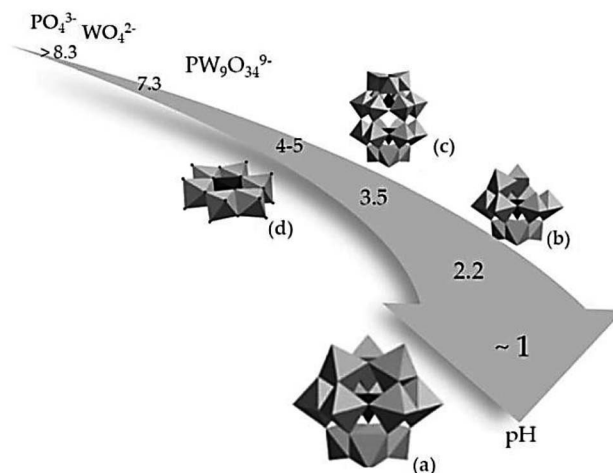
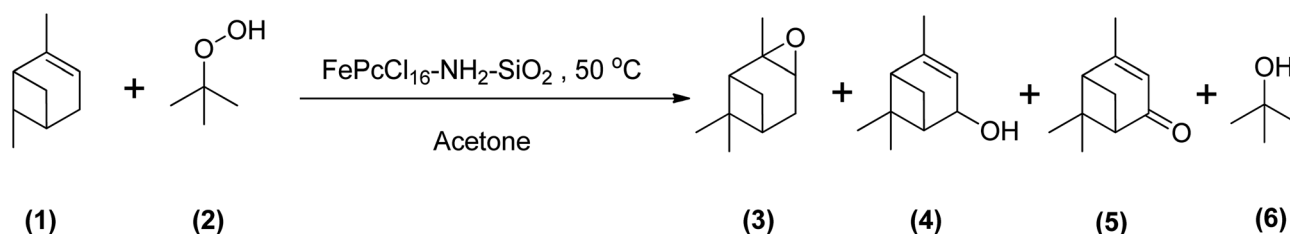


Fig. 3 Influence of acidity on the structure of the polyoxometalates complex, (a) Keggin, (b) lacunary Keggin, (c) Wells–Dawson and (d) Anderson structure.<sup>102</sup>

Fig. 3 illustrates that the formation of a Keggin structure occurs at a pH of approximately 1. This structure is easily synthesized and highly stable with the general formula  $[X^{n+}M_{12}O_{40}]^{(8-n)-}$ . Where P or silica (Si) is commonly used as the central atom (X) and molybdenum (Mo) and W are the addenda atoms (M). Increasing the pH to about 2.2 leads to the hydrolysis of the Keggin structure, resulting in the formation of a lacunary Keggin with the general formula  $[XM_{11}O_{39}]^{n-}$ . Other metal ions, such as iron (Fe<sup>2+</sup>), nickel (Ni<sup>2+</sup>), or cobalt (Co<sup>2+</sup>), can be incorporated into the lacunary Keggin structure. Balula *et al.* (2013) reported the use of lacunary Keggin phosphotungstates as a catalyst for the epoxidation of (*R*)-(+)-limonene with hydrogen peroxide at 80 °C, using acetonitrile as a solvent. They found that the catalyst exhibited high activity, achieving complete conversion of (*R*)-(+)-limonene to limonene-1,2-epoxide, bis-epoxide, and limonene-1,2-diol. In the pH range between 3.5–5, a Wells-Dawson structure with the general formula  $[X_2^{n+}M_{18}O_{62}]^{(2n-16)-}$  and a planar Anderson structure with the general formula  $[X^{n+}M_6O_{24}]^{(12-n)-}$  are typically obtained.

Polyoxometalates (POMs) with transition metal substitutions have gained considerable interest as oxidatively stable catalysts. However, achieving high reaction rates and epoxide yields typically requires the use of chlorinated solvents. Heteropolyanions, formed by fusing an anion at the complex centre



Scheme 21 Epoxidation of (1)  $\alpha$ -pinene with (2) TBHP producing (3)  $\alpha$ -pinene oxide, (4) verbenol, (5) verbenone and (6) *tert*-butanol.



under acidic conditions, have become a focus of research. Various anions, including beryllium (Be), boron (B), aluminium (Al), silicon (Si), germanium (Ge), tin (Sn), and phosphorus (P), can be fused. When counter-ions such as protons ( $H^+$ ),  $Na^+$ ,  $NH_4^+$ ,  $K^+$ , and  $Cs^+$  associate with these structures, a secondary structure (salts) can form. Heteropolyacids (HPAs) are solid POMs composed of heteropolyanions, hydration water, and protons as counter-ions. HPAs have strong acidity, reportedly stronger than mineral acids.  $H_3PW_{12}O_{40}$ , a commonly used POM/HPA species, is a superacid employed in many catalytic processes, including alkylation, acylation, and oxidation.<sup>103</sup> POM catalysts are gaining popularity in oxidation due to their high Brønsted acidity, which provides efficient redox capability enabling rapid reactions and regeneration.<sup>104</sup> The redox mechanism of POMs in oxidation reactions can use either di-oxygen ( $O_2$ ) or hydrogen peroxide ( $H_2O_2$ ) as oxidants, where following the oxidation of the substrate, the POM is re-oxidized by the oxidant.

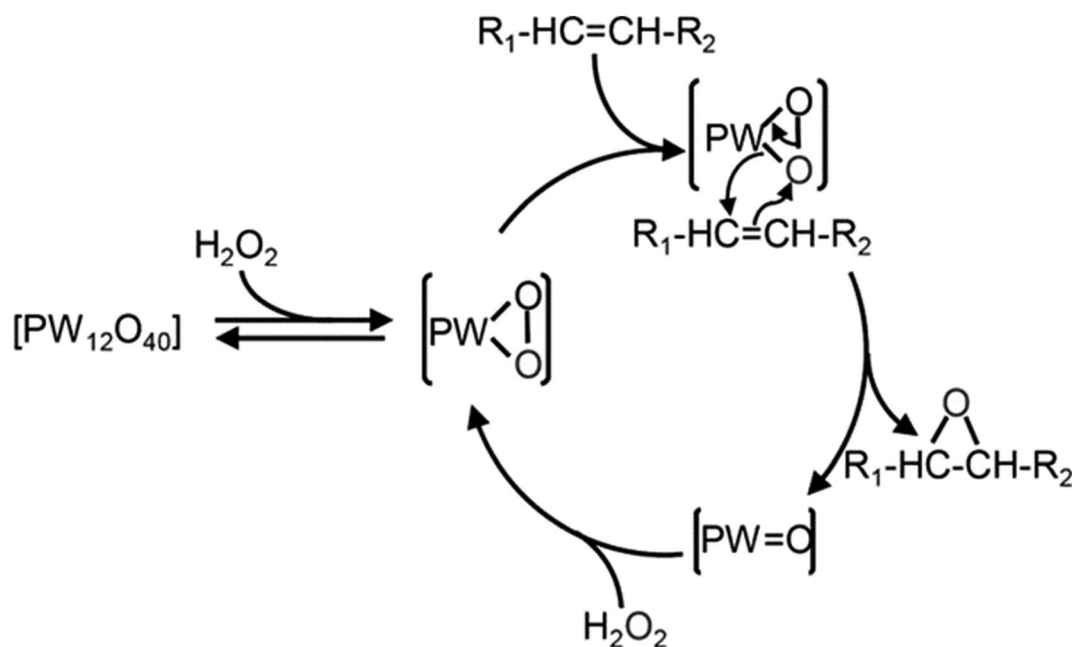
Numerous studies have investigated the suitability of different compounds, such as Fe,<sup>105</sup> Mn,<sup>106</sup> Ru,<sup>107</sup> Re,<sup>108</sup> W,<sup>109</sup> alumina,<sup>110</sup> in addition to hydrotalcite,<sup>111</sup> with hydrogen peroxide for the epoxidation of alkenes. Among these, W-based POM was found to be the most effective  $H_2O_2$ ,<sup>112</sup> whereas commonly used Mo and Ti-based catalysts were less effective with  $H_2O_2$ .<sup>113</sup> The use of POM in epoxidation was first discussed by Venturello *et al.* (1983),<sup>71</sup> who reported the epoxidation of 1-dodecane using  $H_2O_2$  oxidant with  $Na_2WO_4$  and  $H_3PO_4$  in biphasic conditions. They identified the active oxidative species  $[PO_4[W(O)(O_2)_2]_4]^{3-}$ , which is commonly referred to as the Venturello anion ( $PW_4$ ).<sup>74</sup> The mechanism of alkene epoxidation with the Venturello anion is presented in Scheme 22.

Ishii *et al.* (1988) also investigated the suitability of POM for alkene epoxidation.<sup>73</sup> They tested the activity of three POM

species, namely phosphotungstate ( $H_3PW_{12}O_{40}$ ),  $H_4SiW_{12}O_{40}$ , and  $H_3PMO_{12}O_{12}$ , in biphasic conditions using  $H_2O_2$  as an oxidant in chloroform solvent. Among all POM tested, phosphotungstate was found to be the most active. Like Venturello's work, the use of a PTC (quaternary ammonium salts) as a counter-ion was necessary. Fig. 4 depicts the structure of the Venturello anion.

Ishii-Venturello chemistry has gained interest in alkene epoxidation. A study by Duncan *et al.* (1995)<sup>43</sup> investigated the active species, the Venturello anion, in the epoxidation of 1-octene with  $H_2O_2$ . They confirmed the presence of  $PW_4$  as the active species and compared the activity of 11 POMs. The Venturello anion required at least a 50-fold excess of  $H_2O_2$  to form from the P-W precursors. Interestingly, they observed the formation of subsequent peroxy species (SPS) following the interaction of  $PW_4$  species and the substrate. The SPS was rapidly regenerated to form  $PW_4$  species by  $H_2O_2$ , as shown in Scheme 23. The  $PW_4$  species was found to be the most active POM for epoxidation, exhibiting more than double the activity of the peroxotungstate species ( $[[WO(O_2)_2(H_2O)]_2O]^{2-}$ ). However, the use of chlorinated solvents is required to facilitate the catalyst's acid character, which is a disadvantage. Also, the irreversible adsorption of epoxide and diol can deactivate the catalyst.<sup>114,115</sup>

Polytungstophosphate and PTC were used to adapt the mechanism for epoxidizing (*R*)-(+)-limonene and  $\alpha$ -pinene using  $H_2O_2$ , as shown in Fig. 5. The biphasic nature of the epoxidation of (*R*)-(+)-limonene and its oxidative products requires the use of a hydrophobic substrate that is not miscible with aqueous  $H_2O_2$ . Fig. 5 summarizes all the reactions involved in the epoxidation of (*R*)-(+)-limonene. The formation of the oxidative species follows the Ishii-Venturello chemistry, which has been extensively studied in the literature.<sup>12,43</sup> The formation



Scheme 22 Reaction mechanism of alkene epoxidation using Venturello anion as the catalyst.<sup>114</sup>



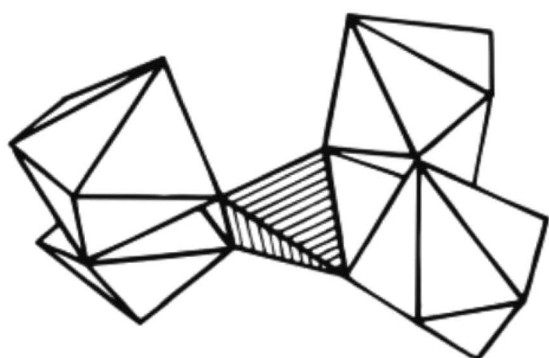
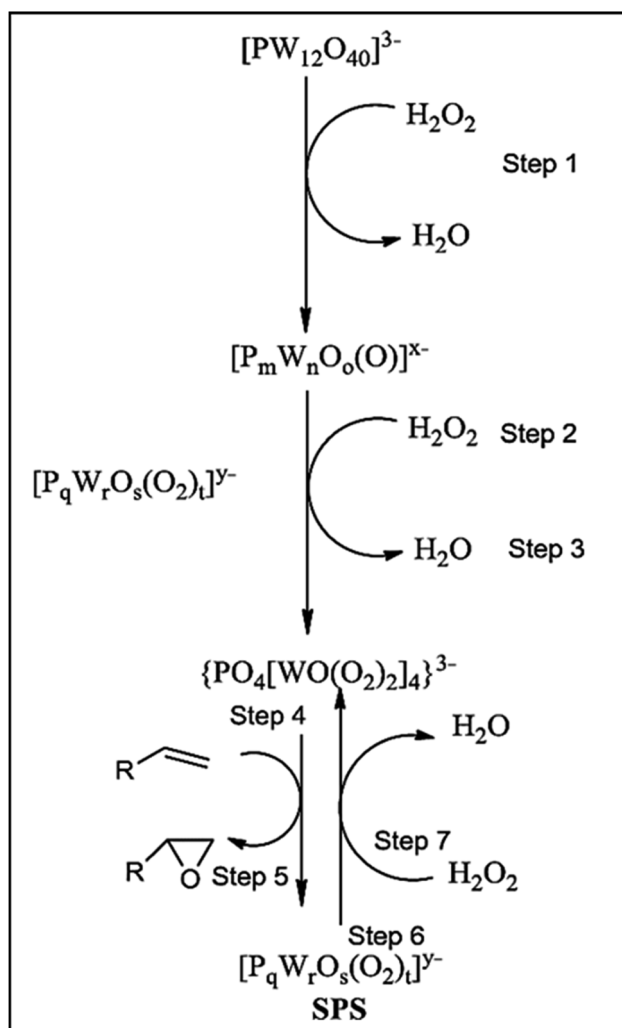


Fig. 4 The visualisation of the structure of Venturello anion ( $PW_4$ ).<sup>116</sup>



Scheme 23 Mechanism of active species formation.<sup>12</sup>

of the polytungstophosphate catalyst from  $H_2O_2$ , tungstate, and phosphate is facilitated by shuttles from the organic phase through PTC ( $Q^+$ ). During the epoxidation reaction, both (*R*)-(+)-limonene and limonene-1,2-epoxide receive active oxygen. The  $H^+$  ions participate in the formation of the oxidative species

as well as the protonic attack on the epoxides at the interphase. When a protonic attack occurs between the epoxides and  $H_2O$  (nucleophile), a diol is formed. POM has been used as a catalyst in significant research on alkene epoxidation, as shown in Table 4.

**3.3.2 Biphasic reactions.** A biphasic reaction system occurs when reactants form two separate phases. The system offers potential advantages such as rapid phase separation and reactant recovery, which can lead to reduced energy costs by using a simple separator instead of a distillation column. In most cases, a catalyst is dissolved in one of the phases, usually the aqueous phase when a metal catalyst is used. Fig. 6 illustrates a simplified version of a biphasic reaction system that shows product separation and recycling.

Typically, one of the phases in a biphasic mixture is a water-based aqueous phase because of the high immiscibility of the organic phase.<sup>117</sup> However, biphasic systems consisting of two fluorinated organic phases or involving ionic liquids have also been used. Examples of biphasic reactions involving the aqueous-organic system include alkylation,<sup>118</sup> carbonylation,<sup>119</sup> Diels–Alder reaction,<sup>120</sup> epoxidation,<sup>71</sup> and hydrogenation.<sup>121</sup> Most organic reactions in a biphasic system are performed using a phase transfer catalyst or in emulsification. Both approaches have many benefits, especially their effect on reaction rates.<sup>122–127</sup> Although one method may be dominant over another, there are instances where the use of one method significantly alters the reaction rates. For example, Menger and Elrington (1991) found that the oxidation of mustard was 80 times faster in emulsification than in a non-emulsified system using a phase transfer catalyst.<sup>128</sup> Some studies have investigated the prospect of having both methods in one system.

Emulsification in a biphasic reaction can also be achieved in a microfluidic and membrane reactor. De Bellefon *et al.* (2000) demonstrated that the isomerisation of allylic alcohol could be emulsified using a microfluidic reactor.<sup>129</sup> They concluded that the application of a microfluidic reactor enhances emulsification, allowing for rapid screening of process variables.

An example of a biphasic epoxidation reaction involving (*R*)-(+)-limonene was reported by Villa *et al.* (2002). They studied the biphasic epoxidation of (*R*)-(+)-limonene using oxidant ( $H_2O_2$ ) with heterogeneous peroxotungstophosphate (Venturello





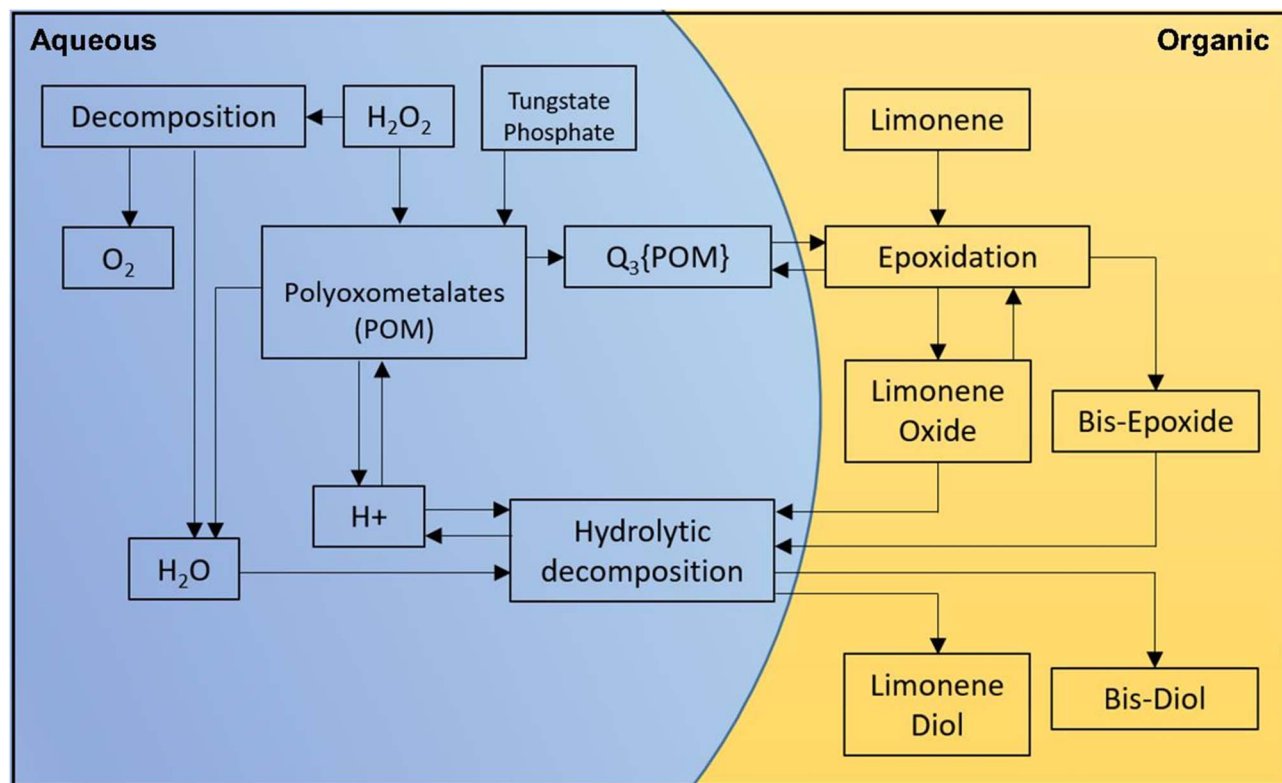


Fig. 5 Overall reaction scheme for the epoxidation of (*R*)-(+)-limonene, the formation of oxidative species, the decomposition of H<sub>2</sub>O<sub>2</sub> and the hydrolytic decomposition of the epoxides. Each reaction is visualized in the schematic diagram (an aqueous phase is shown in blue, while an organic phase is shown in gold).

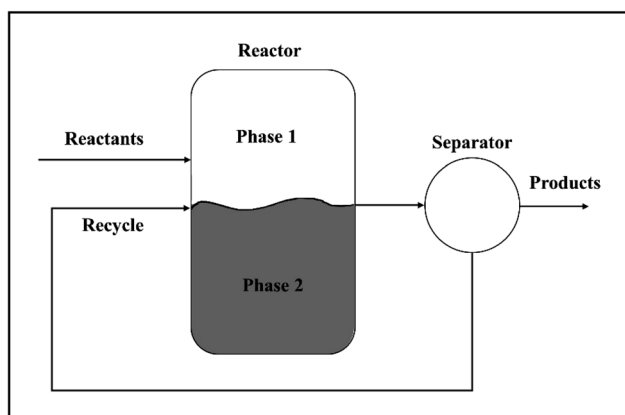


Fig. 6 A simplified version of a biphasic reaction system showing product separation and recycling.

anion) on Amberlite IRA-900 in acetonitrile. According to their results, acetonitrile increased the (*R*)-(+)-limonene concentration in the aqueous phase, highlighting the relationship between the concentration of (*R*)-(+)-limonene and the mass transfer rate in the biphasic system.<sup>130</sup>

**3.3.3 Surfactants.** Surfactants lower the surface tension between two liquids and consist of hydrophobic 'tails' and hydrophilic 'heads'.<sup>131</sup> This unique feature allows each component of the surfactant to be soluble in either an aqueous or

organic medium. When the surfactant's hydrophobic tail aggregates in an organic droplet, an 'oil-in-water' emulsion is formed if the bulk aqueous phase is in contact with the

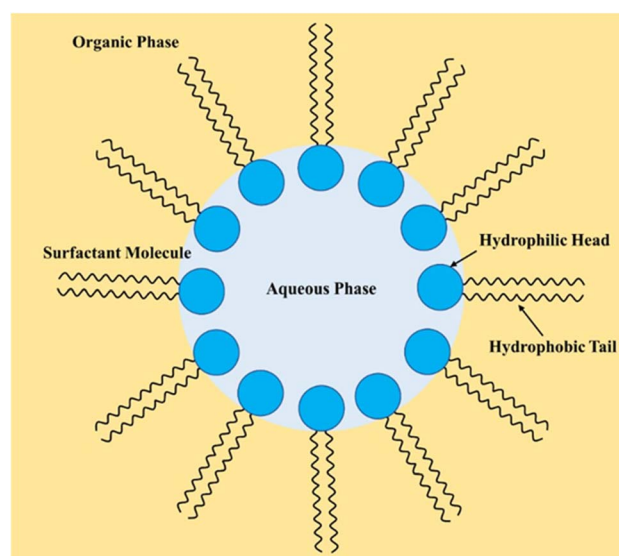


Fig. 7 Schematic of a 'water-in-oil' emulsion where the hydrophobic tail of the surfactant stretches towards the organic phase (gold background). In the meantime, the hydrophilic head remains in the aqueous phase (blue background).





hydrophilic head. Conversely, in a bulk organic phase, particularly in a non-polar solvent environment, the surfactant molecules tend to form a 'water-in-oil' emulsion, where the hydrophilic heads encapsulate the aqueous droplets, while the hydrophobic tails stretch towards the organic phase. Fig. 7 schematically illustrates the formation of a 'water-in-oil' emulsion by the action of surfactant molecules in a biphasic mixture. In biphasic reactions involving two immiscible liquids, surfactants are typically used to form an emulsion. The stability of the emulsions formed depends on the type of surfactant, which is commonly categorised according to the polarity of the hydrophilic head. Table 2 presents the classification of surfactants and examples of surfactants for each class. During biphasic reactions, surfactants function as phase transfer catalysts that facilitate the formation of emulsions, increasing the contact area between the immiscible reactants. Without surfactants, mass transfer limited conditions may occur. In biphasic epoxidation, phase transfer catalysts like quaternary ammonium salts, including Adogen® 464 (methyl trialkyl-(C<sub>8</sub>-C<sub>10</sub>)-ammonium chloride) and Aliquat® 336 (tri octyl methylammonium chloride), are commonly used.<sup>62,79,132-135</sup>

**3.3.4 Phase transfer catalyst.** Phase transfer catalysts (PTCs) are used as chemical catalysts to facilitate phase transfers and transfer reactants from one phase to another for reactions to occur.<sup>136,137</sup> While PTCs are typically classified as a type of heterogeneous catalyst, the product is not in the same phase as the catalyst. PTCs offer a better rate of reaction for a biphasic reaction, which can potentially reduce the use of solvents to achieve a uniform mixture.<sup>138</sup> Quaternary ammonium salts are commonly used as PTCs for a biphasic reaction involving anionic reactants or oxidants, with Table 3 listing common quaternary ammonium salts used as PTCs.

The general mechanism of a PTC in a biphasic mixture is shown in Fig. 8, where the Q<sup>+</sup> ion pairs with the anionic reactants or oxidants (Y<sup>-</sup>) in the aqueous phase before shuttling to the organic phase. Additionally, alkenes (R) absorb active oxygen in the organic phase, allowing the Q<sup>+</sup> to return to the aqueous phase to complete the cycle. The high conversions and

yields associated with PTC epoxidations, which typically occur in two-phase systems, have attracted attention. PTCs can be immobilized as a solid support, making them reusable and avoiding waste problems completely. Furthermore, the process can be made more commercially viable as PTCs are stable at high temperatures, enabling higher conversion rates in less time.

Ahmat and Kaliaguine (2023) present a significant advancement in the field of terpene epoxidation, specifically focusing on limonene and pinene.<sup>54</sup> The main finding of the study is the successful epoxidation of these hydrophobic terpenes using dimethyldioxirane (DMDO) generated *in situ* in a micro-emulsion system. The study highlights the efficacy of cetyltrimethylammonium hydrogen sulfate (CTAHS) as a phase transfer catalyst to homogenize the terpenes in the aqueous reaction medium. The study by Murugan and Siva (2005) presents a novel soluble multi-site phase transfer catalyst (MPTC) named 1,3,5-tris(4-(2,2'-bis(*N*-triethylammoniummethylene chloride)eth-1-ene)phenoxy)methyl)benzene (TBTEAPB).<sup>139</sup> The main finding is that this newly synthesized MPTC significantly enhances the C-alkylation of  $\alpha$ -pinene with epichlorohydrin, especially when compared to single-site and di-site phase transfer catalysts (PTCs).

The TBTEAPB catalyst showed rate constants approximately 6 times higher than single-site PTCs and 3 times higher than di-site PTCs. This indicates a substantial improvement in catalytic efficiency, which is particularly significant for the field of terpene modification. The study also found that the reaction could be facilitated even under mild conditions, such as a low concentration of base (20% NaOH) and lower MPTC concentrations, making the process potentially more sustainable and cost-effective.

Apart from terpenes, PTC is widely used for various alkenes. For instance, Duncan *et al.* (1995) demonstrated the epoxidation of alkenes, such as 1-octene, using heteropolyacids in the presence of a PTC.<sup>43</sup> Using a PTC system, tungsten(vi) and molybdenum(iv) based catalysts were investigated for the epoxidation of alkenes. The amount and nature of PTC

Table 2 Classifications of surfactants and examples of common surfactants

Class	Surfactant head net charge	Examples
Nonionic	No charge	Alkylphenol ethoxylates (Triton™ X-100) (Doong <i>et al.</i> , 1998), <sup>140</sup> sorbitan monolaurate (SPAN® 20), polyethene glycol sorbitan monolaurate (TWEEN® 20) (Bishopp <i>et al.</i> , 2014) <sup>141</sup>
Anionic	Negative	Sulfonate: perfluorooctanesulfonate (PFOS) (Vecitis <i>et al.</i> , 2008), <sup>142</sup> carboxylate: sodium stearate (Wang <i>et al.</i> , 2010) <sup>143</sup>
Cationic	Positive	Quaternary ammonium salts: cetyl methyl ammonium bromide (CTAB) (Doong <i>et al.</i> , 1998), <sup>140</sup> methyltrialkyl (C8-C10) ammonium chloride (Adogen® 464) (Lee and chang, 1978) <sup>144</sup>
Zwitterionic	Negative and positive (two heads)	Cocamidopropyl betaine (CAPB) (Hunter and Fowler Jr, 1998), <sup>131</sup> phosphatidylethanolamine (Attwood <i>et al.</i> , 1992) <sup>145</sup>



Table 3 Common quaternary ammonium salts used in biphasic reactions

Type	Example reaction	References
Benzyltriethylammonium chloride	Alkylation	(Kimura <i>et al.</i> , 1983) <sup>146</sup>
Methyltricaprylammonium chloride/ methyltrioctylammonium chloride	Oxidation	(Venturello and D'Aloisio, 1988; Neumann and Gara, 1994) <sup>74,147</sup>
Methyl tributyl ammonium chloride	Esterification	(Desikan and Doraiswamy, 2000) <sup>148</sup>

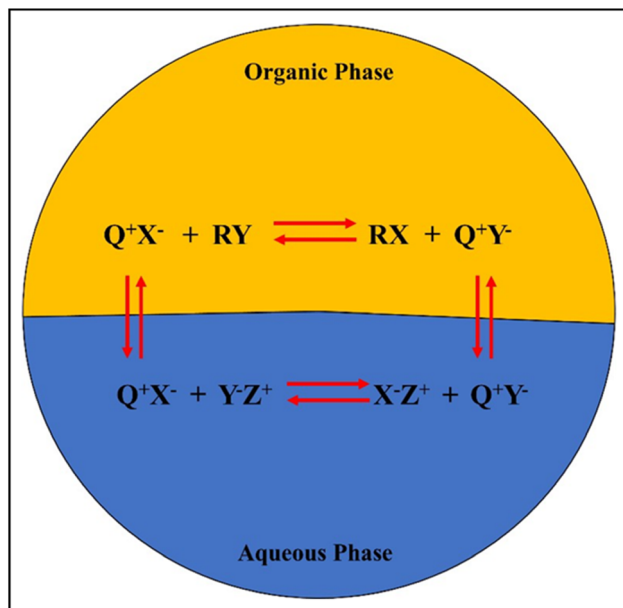


Fig. 8 Mechanism of PTC in a biphasic mixture.

determine alkene oxidation, in addition to the assembling anion of the catalyst.<sup>149</sup> Similarly, Sato *et al.* (1996) described the catalytic epoxidation of alkenes using  $\text{H}_2\text{O}_2$  in a system comprised of sodium tungstate catalyst, aminomethylphosphonic acid, and methyl tri-*n*-octyl ammonium hydrogen sulphate as the PTC, where both solvent and solvent-free epoxidation showed high product yield corresponding to the PTC amount. One study found that using quaternary ammonium heteropolymer-tungstate degraded quickly to oxoperoxophosphate ions, which increased the yield of the epoxidation reaction system.<sup>150</sup>

Chen *et al.* (2004) reported the epoxidation of alkenes in a PTC system using acidic media and an organic solvent.<sup>125</sup> In their study, they found that  $\text{H}_2\text{O}_2$  is the best oxidant and sodium tungstate, and phosphoric acid are the best catalysts for this process. Phosphate and sulphate anions were tested in a recent study to assess how they affected the epoxidation of alkene in Arquad 2HT® systems.<sup>132</sup> In the reaction, both anions were found to be effective. The phase transfer catalyzed system also showed that tungsten(IV) had a stronger activity than sodium tungstate. Bishopp *et al.* (2014) used tungsten catalysts to epoxidize sunflower seed oil with  $\text{H}_2\text{O}_2$ , without the presence of common PTC. To overcome the mass transfer limitation associated with the biphasic system, a non-ionic surfactant was used to create emulsions. The

emulsification reduced the diameter of droplets and facilitated the reaction. The researchers discovered that  $\text{H}_2\text{O}_2$  decomposition increased exponentially above a certain catalyst concentration, which reduced the epoxidation rate by starving the system of oxidants. However, when the catalyst concentration was lower, the  $\text{H}_2\text{O}_2$  decomposition was exceptionally low. By adding acetic acid to the tungsten catalyst, the  $\text{H}_2\text{O}_2$  decomposition was almost negligible. They found that  $\text{H}_2\text{O}_2$  was first order at lower catalyst concentrations.<sup>142</sup>

The separation of PTC from the reaction mixture has become a significant concern, leading to research on polymer-supported PTC. Desikan and Doraiswamy (2000) used aqueous sodium acetate to esterify benzyl chloride. They compared the activity of methyl tributyl ammonium chloride dissolved in a polymer with that of methyl tributyl ammonium chloride supported on a polymer. The supported PTC showed about 50% higher activity than the soluble form and was easy to separate post-reaction.<sup>148</sup>

The PTC agent typically consists of a cation part (*e.g.*, quaternary ammonium,  $\text{Q}^+$ ) and an anion part (*e.g.*, chloride,  $\text{X}^-$ ). Fig. 8 shows the general mechanism of a PTC in a biphasic mixture.

**3.3.5 Role of additives: sodium sulphate ( $\text{Na}_2\text{SO}_4$ ).** Sodium sulphate ( $\text{Na}_2\text{SO}_4$ ) is commonly used as a drying agent, and in aqueous solutions, it ionizes into  $\text{Na}^+$  and  $\text{SO}_4^{2-}$  ions, exhibiting a neutral pH of 7. The salt can form a decahydrate, which can mop up to 10 molecules of  $\text{H}_2\text{O}$  per molecule of the salt.<sup>153</sup> The use of an acidic catalyst and the presence of  $\text{H}_2\text{O}$  was found to be detrimental to the stability of epoxides in a biphasic epoxidation reaction using aqueous  $\text{H}_2\text{O}_2$ .<sup>152</sup> To prevent the hydrolysis of the epoxides, the addition of sodium sulphate was reported to be effective in improving selectivity toward acid-labile epoxides. A recent study showed that only  $\text{Na}_2\text{SO}_4$  was able to suppress the hydrolysis and ring-opening of  $\alpha$ -pinene epoxide, and saturation with the salt was required to achieve the highest selectivity of the epoxides.<sup>78</sup> This effect could be attributed to  $\text{Na}_2\text{SO}_4$  acting as a salting-out agent rather than a drying agent. The salting-out process affects the solubility of non-electrolytes in water, and  $\text{Na}_2\text{SO}_4$  shows remarkable repulsion on non-electrolytes compared to other anions, with  $\text{Na}^+$  cations showing synergism with  $\text{SO}_4^{2-}$  anions.<sup>153</sup> This salting-out effect could explain the peculiarities of using  $\text{Na}_2\text{SO}_4$  in preventing the hydrolysis of acid-labile epoxides. Salting-out extractions are commonly used in biochemistry, facilitating the recovery of organic compounds in an aqueous medium, and the hydrophobic effect causes solutes to aggregate and be repulsed.



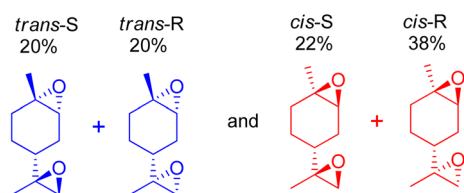
### 3.4 Stereoselective terpene epoxidation

Orange peel essential oils are rich in the (*R*)-enantiomer of limonene, which is also known as *D*-limonene (+)-limonene), a chiral molecule. Limonene bis-epoxide produces two isomers with distinct arrangements of the epoxide bridges for each limonene enantiomer, resulting in diverse reactivities relevant to subsequent polymerizations. Cunningham *et al.* (2020) used an aqueous H<sub>2</sub>O<sub>2</sub> oxidant to epoxidize a variety of trisubstituted alkene bond-containing terpenes using tungsten-based polyoxometalate catalysts, which always produced two diastereomers, racemic mixtures of the *cis*- and *trans*-epoxides of each terpene.<sup>97</sup> Similarly, mesoporous SBA-16 substituted with cobalt was used to produce *cis*- and *trans*-diastereomers of limonene by aerobic epoxidation, and the products had a precise distribution of 60 : 40 *cis* : *trans* limonene bis-epoxide (Scheme 24).<sup>50</sup>

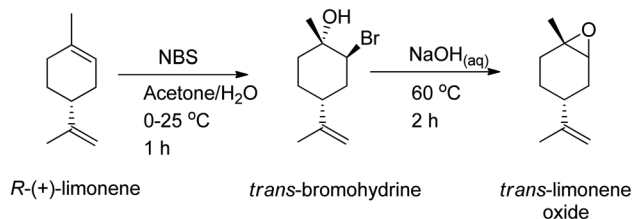
Zinc β-diminate complex was used as a catalyst to synthesize poly(limonene carbonate) from a *cis/trans* combination of (*R*)- and (*S*)-limonene oxide, which showed that *trans*-diastereomers of the epoxide are easily polymerized while the *cis*-diastereomers are left unreacted, resulting in high regio, diastereoisomer, and enantiomerically pure polymer.<sup>154-156</sup> Recent studies have shown that the limonene-1,2-epoxide mixture (available commercially *i.e.* 40 : 60, *cis* : *trans*) can be used to synthesize polycarbonates and cyclic carbonates with a higher conversion of the *trans*-isomer than the *cis*-isomer in the presence of tetrabutylammonium halides (TBAX) as catalysts.<sup>155,157</sup> The diastereomeric *cis*-has lower reactivity than the *trans*-due to the “boat-like” form of its transition state, which is correlated with its higher activation energy. A stereoselective epoxidation method needs to be developed to continue producing terpenes in their *trans*-form. Hauenstein *et al.* (2016) proposed a large-scale stereoselective synthesis method for the *trans*-isomer of limonene-1,2-epoxide (>1 kg per batch) by brominating (*R*)-(+)-limonene with *N*-bromosuccinimide (NBS) in an aqueous acetone solution.<sup>155</sup> Endo-cyclic *trans*-bromohydrin is formed, which is readily oxidized into subsequent *trans*-limonene-1,2-epoxide by using a 60 °C aqueous sodium hydroxide solution for 2 hours (Scheme 25).

The amount of *trans*-limonene-1,2-epoxide in the resulting products was found to be more than 85%. Recent studies have shown that both the exocyclic and endocyclic double bonds of (*R*)-(+)-limonene can be stereoselectively di-bromohydrated to form *trans*-limonene bis-epoxide (Scheme 26).

Various parameters, such as reaction temperature, time, and the molar ratio of (*R*)-(+)-limonene to *N*-bromosuccinimide (NBS), were examined to produce *trans*-limonene bis-epoxide.



Scheme 24 Various isomers of limonene bis-epoxide are produced from (*R*)-(+)-limonene.

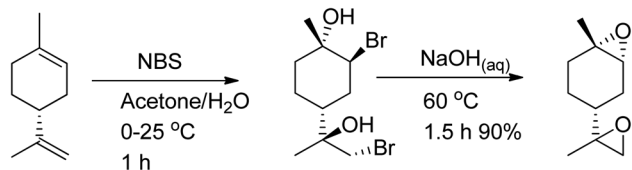


Scheme 25 As a bromination source, NBS is used to undergo stereoselective epoxidation of (*R*)-(+)-limonene.

The optimal conditions were found to be a 1 : 2 (*R*)-(+)-limonene : NBS molar ratio at 60 °C for 5 minutes, which resulted in a 97% yield. Furthermore, a stereoselective epoxidation mechanism for (*R*)-(+)-limonene was proposed, leading to the formation of *trans*-limonene bis-epoxide. The mechanism involves the production of a bromonium ion intermediate from the reaction between (*R*)-(+)-limonene and NBS in acetone and water (Step 1 in Scheme 27), which is then attacked by the hydroxyl group of water to form bromohydrin (Step 2) and eventually *trans*-limonene bis-epoxide. The excess NBS causes both double bonds to be bromohydrated (Step 3). Faster epoxidation reactions were observed, and it was suggested that the production of *trans*-limonene bis-epoxide occurred through an intramolecular S<sub>N</sub>2 reaction in which NaOH deprotonated OH to form an alkoxide intermediate, which then attacked the C–Br to replace the bromide ion as a leaving group (Step 4).

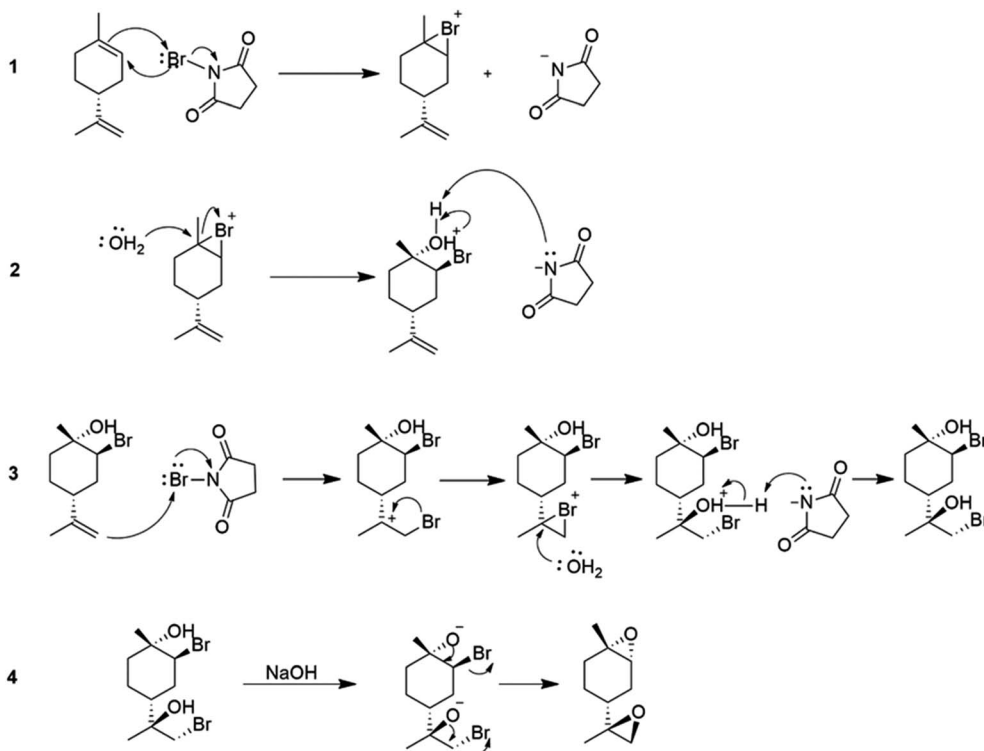
### 3.5 Reactor optimisation

**3.5.1 Batch epoxidation limitation.** Batch epoxidation is a common method used to produce fine chemicals and pharmaceuticals, mainly due to the accessibility of expensive chemical plant equipment and the fundamental technologies and processes available. However, this method also has drawbacks, such as the accumulation of reactive intermediates that can result in the formation of undesirable by-products, fires, and explosions. Small flasks can be used for rapid mixing, but this can lead to selectivity losses in larger reactors, and large vessels are prone to localized hotspots that compromise safety.<sup>158</sup> Additionally, scaling up batch processes can result in the development of by-products and highly exothermic reactions that require constant cooling, posing a challenge for efficient and safe operation.<sup>159</sup> One possible solution to increase the efficiency of chemical processes and minimize waste generation is flow chemistry, which allows for the development



Scheme 26 Using both (*R*)-(+)-limonene's exocyclic and endocyclic double bonds as starting materials, *trans*-LBE is synthesized via stereoselective di-bromohydrination.





Scheme 27 NBS-mediated stereoselective epoxidation of (*R*)-(+)-limonene, reaction mechanism.

of continuous chemical processes that can be scaled up for industrial production with better safety and effectiveness.<sup>160</sup>

**3.5.2 Advantages of flow chemistry.** Flow chemistry and continuous processing offer sustainable and environmentally friendly alternatives for chemical synthesis. By combining small-scale synthesis with industrial manufacturing, a more reliable, scalable, effective, and secure synthetic process can be achieved. In flow chemistry, a continuous flow of chemicals is reacted in tubes and reactors, allowing for efficient mixing and preventing the buildup of unreacted chemicals.<sup>161</sup> Mixing reagents is one of the key benefits of flow chemistry and continuous processes, which can be achieved using mixers that create turbulent micro-mixing, such as static mixers. This process stream provides good temperature control, and efficient reagent mixing, and prevents the formation of side products and temperature hot spots.<sup>162</sup> Flow chemical methods also use less or no solvent when reactants are mixed effectively, and the large surface area to volume ratios in compact reactors enable more precise control of reaction temperatures and shorter reaction periods. This means that flow reactor tubes can be intensified and more environmentally friendly, and optimization of cryogenic and high-temperature reactions can be achieved using continuous procedures.

Ranganathan and Sieber (2017) present an innovative approach to epoxidizing olefins like monoterpenes (3-carene, limonene, and  $\alpha$ -pinene) by coupling the anthraquinone autooxidation process for hydrogen peroxide ( $H_2O_2$ ) production with lipase-mediated epoxidation.<sup>163</sup> Utilizing *Candida antarctica* lipase B (CALB) and a unique hybrid reactor setup, the study

overcomes the limitation of continuous  $H_2O_2$  addition, a common drawback in traditional methods. The process achieved high yields of epoxides (up to 88.8% for 3-carene and 83.8% for  $\alpha$ -pinene) and allowed for the reuse of the catalyst for up to five cycles with minimal loss of activity. The study concludes that this semi-continuous approach is scalable to industrial standards and offers a broad range of applications due to its efficiency and sustainability.

The flow chemistry method also allows efficient photochemical reactions to be started by passing reaction streams through UV lamps or other light sources, and solid-supported reagents can be used as reactants to facilitate the purification process. Moreover, the ability to handle hazardous or toxic reagents safely is another benefit of continuous processes.

Microreactors offer an effective solution to reduce waste production and provide excellent reaction and thermal control due to their narrow channel diameters and static mixers, which allow for extremely good mixing in the millisecond range. Concentrated solvents or no solvents at all can be used, which reduces the amount of waste produced.<sup>162</sup> Real-time process analytical technology (PAT) provides in-depth data for mechanistic research and ensures high-quality chemical outputs. The benefits of flow chemistry and continual processing methods can be increased by synthesizing chemicals in miniature micro- or milli-reactors, which typically have volume capacities between nanoliters and milliliters.<sup>164</sup> Scaling up a continuous flow reactor can be achieved by operating it for a longer time or by using a “numbering up” method to execute reactions in several reactors simultaneously. Alternatively, large continuous





flow reactors can be built to produce large quantities of product but may require more process development.<sup>165</sup> In conclusion, flow chemistry and continuous processing provide sustainable and environmentally friendly alternatives to traditional batch synthesis methods, offering benefits such as efficient mixing, better temperature control, and reduced waste production. These methods can be further optimized using microreactors and real-time process analytical technology.

### 3.5.3 Epoxidation of terpenes by continuous process.

Recently, we addressed the challenge of mass and heat transfer during epoxidation by using a process intensification approach.<sup>6</sup> We investigated a continuous mode of epoxidizing limonene and  $\alpha$ -pinene with  $H_2O_2$  using mesoscale oscillatory baffled reactors (meso-OBRs) with three-dimensionally printed mesoscale orifice baffles and conventional baffles (Fig. 9). We evaluated the performance of meso-OBRs in a solvent-free condition in a single-step addition of oxidant in terms of the induction period, steady-state quality, and heat transfer capability. We also examined whether meso-OBR could be used in a heat pipe assembly for low-energy intensive and passive isothermalization. Different meso-OBR designs were used to continuously epoxidize terpenes with  $H_2O_2$  in a solvent-free environment (Fig. 10). We conducted a comparative analysis of the performance of new 3D-printed baffles with single, tri-

and multi-orifices and conventional baffles with helical and integral ones (Fig. 11). The performance investigated included mixing intensity, induction period, multi-steady-state, and heat removal capability of the meso-OBR. We found that using tri- and multi-orifice did not intrude on the reaction's mixing limitations, and the rate of reaction was comparable to batch at mixing conditions of  $Re_o > 850$  and  $Re_o > 500$ , respectively. The tri- and multi-orifice baffles achieved steady-state quickly and had a shorter induction period ( $t = 1.5$ ) and better reproducibility, with a variation of only 1.3%.

The smaller orifice diameters of tri- and multi-orifice baffles induce smaller drop sizes while increasing the surface at the same time, resulting in enhanced reaction rates. Multi-orifice baffles showed fewer variances in limonene epoxide yields than other baffle designs, indicating a high extent of plug flow and reproducibility. In a multi-steady-state screening of residence time, multi-orifice baffles could screen the parameter in half the time as helical baffles and just a fraction of the time as batch baffles. Tight control of process parameters enabled clear steady states to be attained at all residence times. The meso-OBR designs demonstrated efficient heat transfer capability under solvent-free conditions, enabling the reaction to become isothermal with a temperature change of just  $\pm 1$  °C. By doing so, the need for solvent is eliminated, resulting in a 5-fold

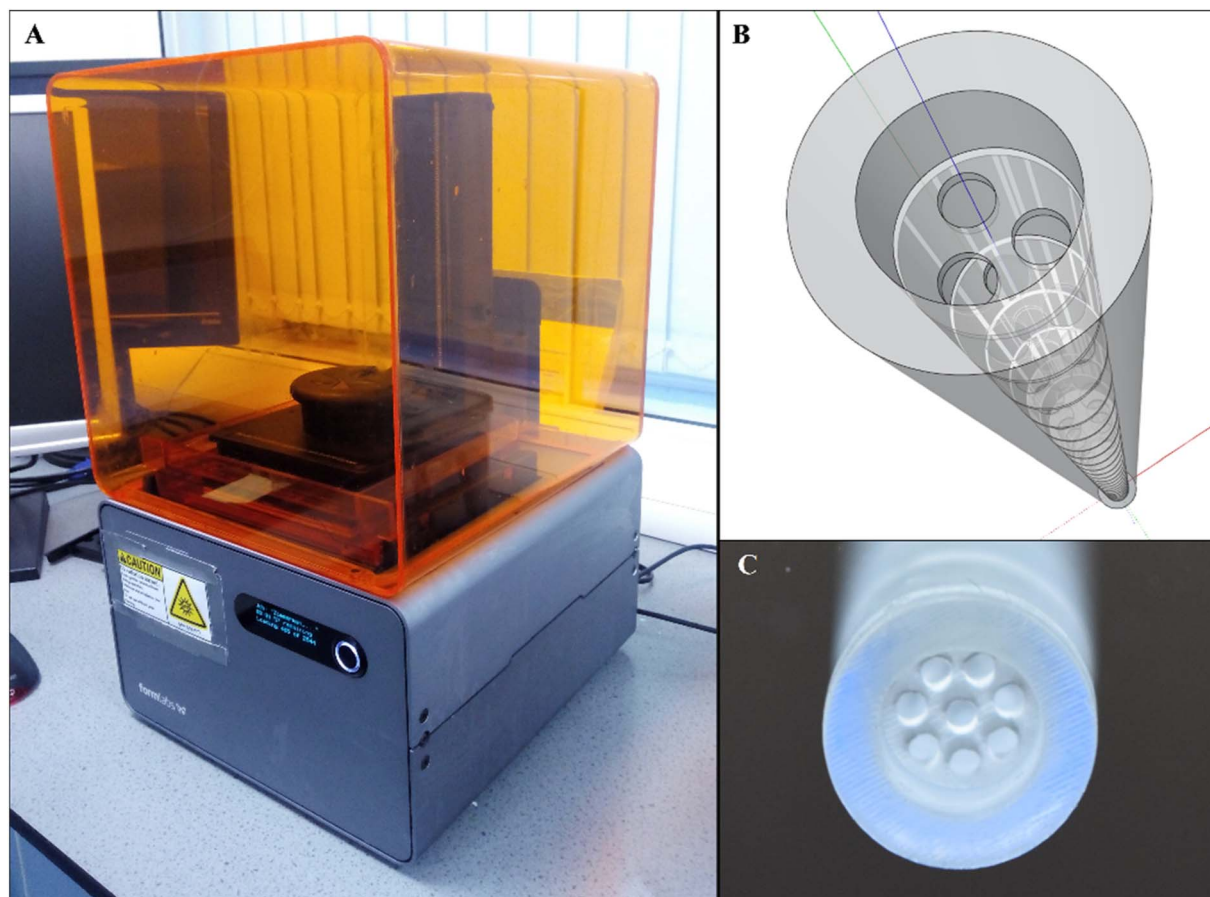


Fig. 9 An application of additive manufacturing to fabricate millimetre-scale orifice baffles. (A) Form2 SLA 3D printer (B) a SketchUp drawing model showing a tri-orifice baffle (C) a printed, cured and cleaned multi-orifice baffled meso-OBR reactor.<sup>5</sup>





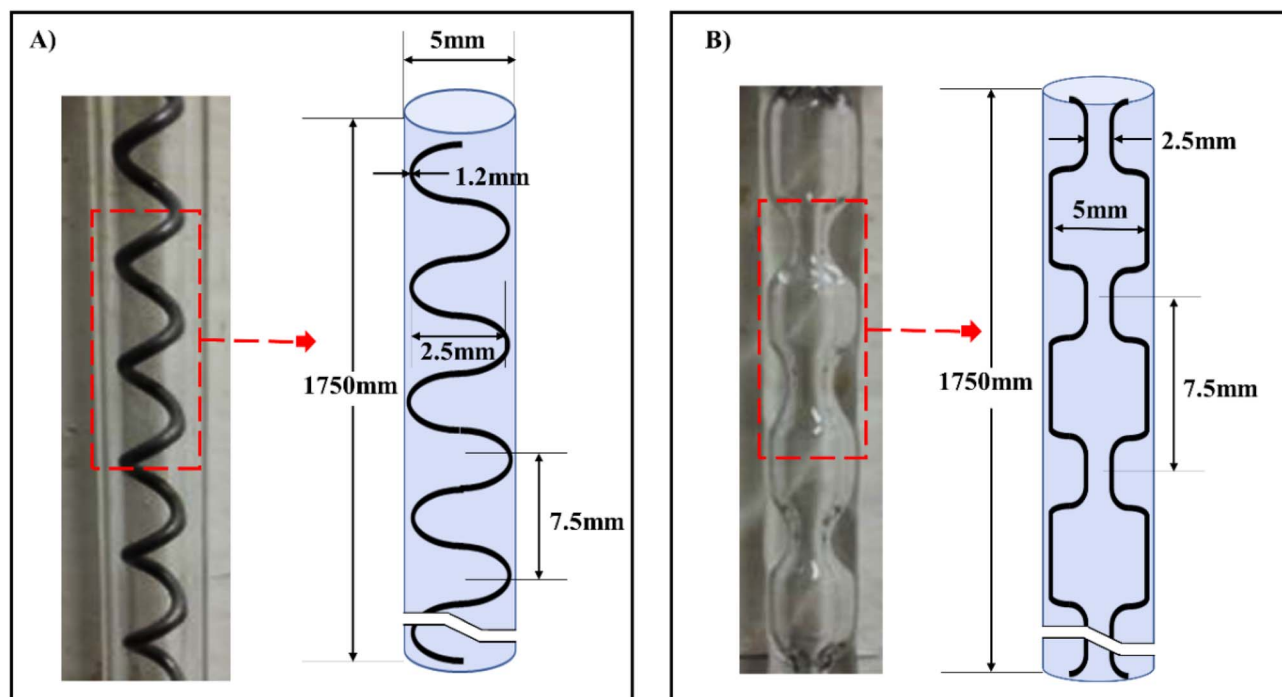


Fig. 10 Meso-OBRs designs configuration and schematics of the conventional, (A) helical baffles (B) integral baffles.<sup>5</sup>

decrement in required reaction volume. Using multi-orifice meso-OBRs, terpenes can be epoxidized with  $H_2O_2$ , by up to an 80-fold intensification factor. We used helically baffled meso-OBRs to continuously epoxidize terpenes with  $H_2O_2$  (Fig. 12). With multi-orifice meso-OBRs, the epoxidation of terpenes with  $H_2O_2$  can be completed in just 30 minutes instead of the 8 hours required by conventional processes.

Tibbetts *et al.* (2021) demonstrated a solvent-free continuous flow epoxidation process of bio-renewable terpene feedstocks using a recyclable polyoxometalate (POM) phase transfer catalyst (PTC) made of tungsten and aqueous

$H_2O_2$ .<sup>166</sup> The flow epoxidation was performed on a variety of bio-renewable terpene substrates, resulting in the production of large amounts of limonene 1,2-epoxide (Fig. 13). The use of static mixing channels in the flow microreactor enhanced heat and mass transfer rates between organic and aqueous streams, resulting in rapid epoxidation reactions with temperature control. The recovered catalyst can be recycled to produce additional epoxides, making it possible to obtain milligrams of a variety of epoxides by epoxidizing di- and tri-substituted alkenes. In contrast to biphasic batch epoxidation conditions, which can have potential hazards of thermal

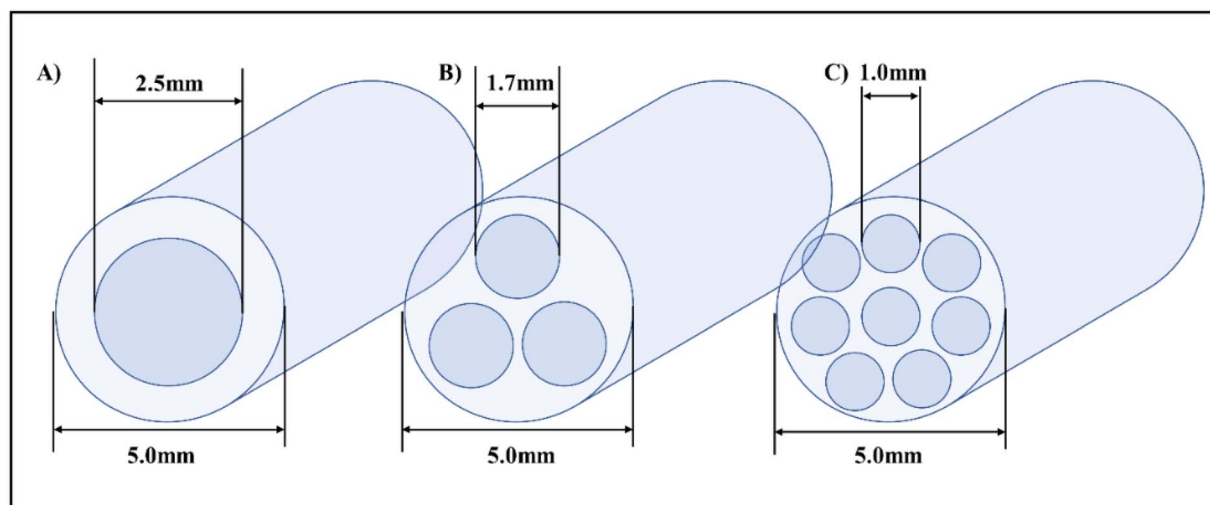


Fig. 11 Orifice meso-OBR design schematics and configurations for 3D printing, (A) single orifice (B) tri-orifice (C) Multi-orifice.<sup>5</sup>



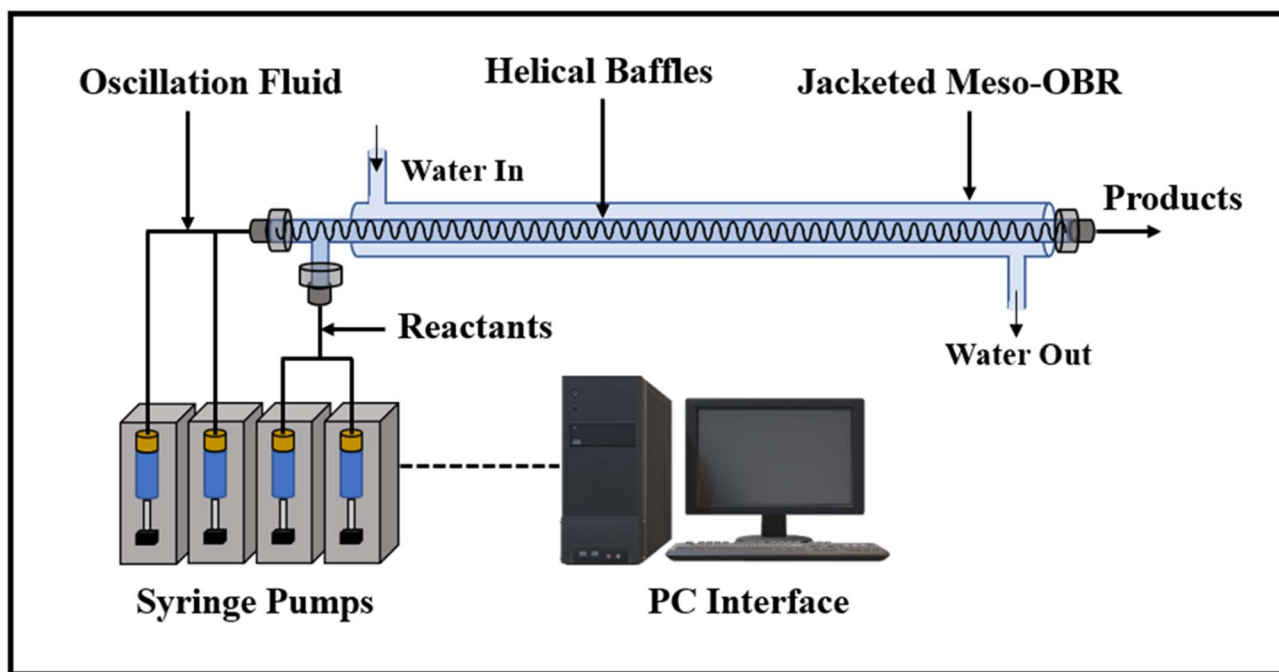


Fig. 12 The helically baffled meso-OBR is used for the flow epoxidation of terpenes with  $\text{H}_2\text{O}_2$ .<sup>5</sup>

runaway reaction due to poor temperature control and ineffective mixing, flow epoxidation has a multitude of advantages suitable for large-scale epoxide production.  $\text{H}_2\text{O}_2$  is an effective oxidant for catalytic epoxidation reactions in flow reactors for petroleum-based substrates. The use of static mixing channels in the flow microreactor enhances heat and mass transfer rates, making it possible to achieve 89% conversion of limonene to limonene 1,2-oxide and 90% selectivity with a residence time of 16.7 minutes. To achieve this, a 7.5 mL volume microreactor containing 2 mol% VPTC and 1.6 equivalents of  $\text{H}_2\text{O}_2$  (pH 7.0) flowing at  $27 \text{ mL h}^{-1}$  was used under optimal conditions.<sup>168</sup>

In previous studies,  $\alpha$ -pinene oxide produced with  $\text{H}_2\text{O}_2$ /VPTC in batch epoxidation was found to be hydrolyzed to its anti-diol. However, under flow conditions, the addition of 30 mol%  $\text{Na}_2\text{SO}_4$  to aqueous  $\text{H}_2\text{O}_2$  (pH 7.0) with a high catalytic loading of 3 mol% resulted in a 95% conversion and selectivity for the corresponding oxide (Fig. 14). Similarly, using a high temperature and catalytic loading ( $75 \text{ }^\circ\text{C}$  and 5 mol%) with a shorter static mixer residency time of 1.65 min, a total conversion of  $\beta$ -pinene into its respective  $\beta$ -pinene oxide with 55% conversion and 99% selectivity was achieved. We applied the same flow epoxidation protocol to untreated industrial CST, the world's largest renewable monoterpene feedstock, with high

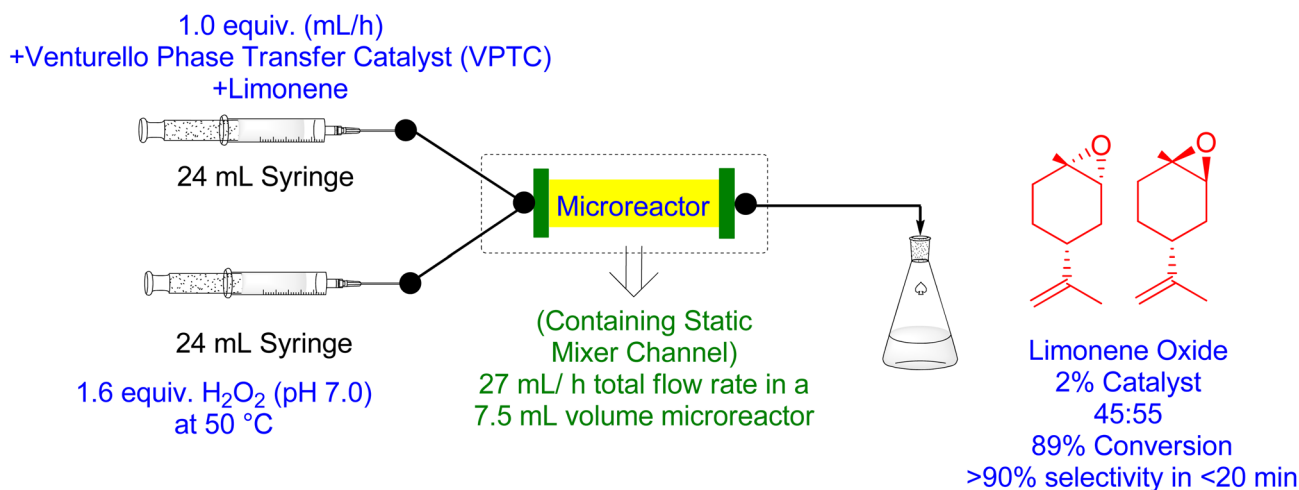


Fig. 13 Catalytic flow epoxidation of limonene using Venturello Phase Transfer Catalyst (VPTC) (reproduced from ref. 166).



Untreated industrial waste from terpene biorefinery  
11.6 ml/h, 73 mmol/h, 1.0 equiv. Feed  
+ 5 mol % catalyst

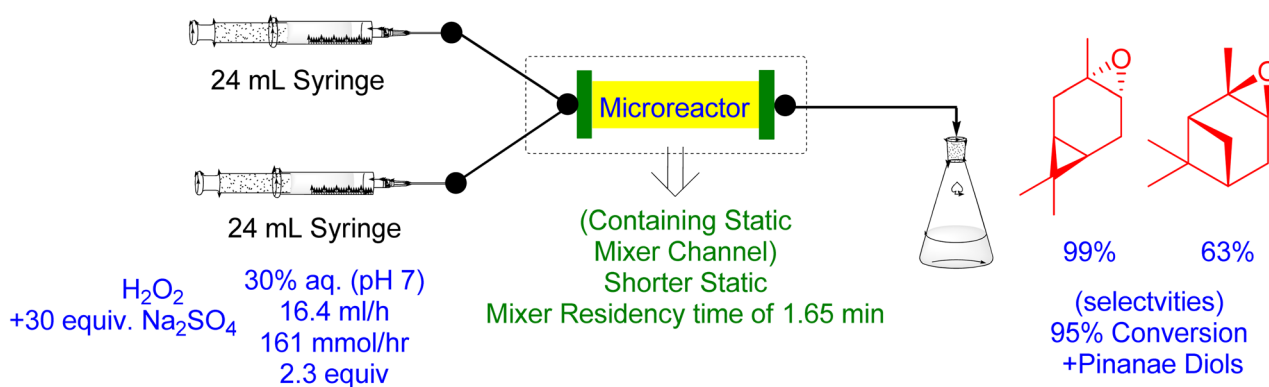


Fig. 14 Catalytic flow epoxidation of Untreated Industrial waste from biorefinery using Venturello Phase Transfer Catalyst (VPTC) (Reproduced from ref. 166)

Table 4 List of research on alkene epoxidation using POM as a catalyst

POM catalyst	Substrate	Oxidant	Temperature	Solvent	Conversion (%)	Selectivity (%)	Reference
$[\text{M}_4(\text{H}_2\text{O})_2(\text{PW}_9\text{O}_{34})_2]^{n-}$ , M = Co(II), Mn(II) and Fe(III)	(R)-(+)-Limonene	$\text{H}_2\text{O}_2$	80 °C	Acetonitrile	Co(II), Mn(II), Fe(III) = 86%, 68%, 89%	Co(II), Mn(II), Fe(III) = 51%, 82%, 77%	Santos <i>et al.</i> , 2017 (ref. 167)
$\text{K}_{10}[\text{M}_4(\text{H}_2\text{O})_2(\text{PW}_9\text{O}_{34})_2] \cdot 20\text{H}_2\text{O}$ M = Cu(II)	(R)-(+)-Limonene	$\text{H}_2\text{O}_2$	2 °C	1,2-Dichloroethane	96%	95% to limonene-1,2-epoxide	Egusquiza <i>et al.</i> , 2012 (ref. 62)
$[\text{SeO}_4[\text{WO}(\text{O}_2)_2]_2\text{S}_2]$	Cyclohexene	$\text{H}_2\text{O}_2$	Ambient	Acetonitrile	99%	97% to cyclohexene oxide	Kamata <i>et al.</i> , 2010 (ref. 168)
$[\text{Ti}_2(\text{OH})_2\text{As}^{2-}\text{W}_{19}\text{O}_{67}(\text{H}_2\text{O})]^{8-}$	(R)-(+)-Limonene	$\text{H}_2\text{O}_2$	50 °C	Acetonitrile	76%	75% to limonene-1,2-epoxide	Donoeva <i>et al.</i> , 2010 (ref. 169)
$[\text{PW}_4\text{O}_{32}]$	Cyclooctene	$\text{H}_2\text{O}_2$	65 °C	Ethyl acetate	99%	99% to cyclooctene oxide	Ding <i>et al.</i> , 2008 (ref. 170)
$\text{Na}_2\text{WO}_4/\text{H}_2\text{WO}_4$	Cyclooctene	$\text{H}_2\text{O}_2$	60 °C	Solvent-free	99%	99% to cyclooctene oxide	Maheswari <i>et al.</i> , 2006 (ref. 171)
$\text{Na}_8\text{H}[\Delta\text{PW}_9\text{O}_{34}] \cdot 19\text{H}_2\text{O}$	(R)-(+)-Limonene	$\text{H}_2\text{O}_2$	2 °C	1,2-Dichloroethane	100%	96% to limonene-1,2-epoxide	Casuscelli <i>et al.</i> , 2005 (ref. 57)

catalytic loading and the equivalent of  $\text{H}_2\text{O}_2$  (5 mol% and 2.2) and the addition of 30 mol%  $\text{Na}_2\text{SO}_4$ . After a total residence time of 15 min at 60 °C, the three main components ( $\alpha$ -pinene, 3-carene, and  $\beta$ -pinene) were consumed up to 95%, resulting in the production of  $\alpha$ -pinene oxide (63%) and 3-carene oxide with excellent selectivity.<sup>166</sup>

## 4. Conclusions and prospects

The olefinic terpene family is a promising renewable resource that could lead to significant economic gains in various chemical industries. Terpenes can be found in the resin of coniferous trees and the essential oils of citrus fruits, and epoxidation reactions are a promising approach for transforming them into value-added compounds for the pharmaceutical, fragrance, and flavouring industries. This critical review analyzes catalytic oxidative upgrades of renewable terpene olefins and discusses the challenges in achieving high selectivity and yields with complex reaction mixtures, hazardous organic solvents, and high concentrations of

oxidants. While the review by Mahamat *et al.* (2021)<sup>6</sup> offers valuable insights into limonene epoxidation using various oxidants, our work uniquely addresses the complexities of achieving high selectivity and yields in the presence of multiple challenges such as hazardous solvents and oxidants. We believe that our focus on these aspects, as well as on the potential synergy between heterogeneous and homogeneous catalysis, adds a distinctive layer of understanding to the field. Further advancements are needed to achieve industrial demands, and thorough knowledge of reaction mechanisms is necessary to design epoxidation catalysts that are highly active, selective, environmentally friendly, and cost-effective. The synergy between heterogeneous and homogeneous catalytic properties could be highly beneficial, but satisfactory catalyst systems that offer rates and selectivity equivalent to those of homogeneous counterparts are still lacking. Research on surfactants, phase transfer catalysts, inorganic salts, and reaction kinetics is necessary to guide the future design of innovative catalysts for green epoxidation that are simple to separate and regenerate.



## Conflicts of interest

There are no conflicts to declare.

## Acknowledgements

The lead author expresses his gratitude for the financial support provided by an Engineering and Physical Sciences Research Council (EPSRC) grant (Sustainable Polymers, grant number EP/L017393/1) and the Ministry of Higher Education, Malaysia.

## References

- 1 Y. Zhu, C. Romain and C. K. Williams, Sustainable polymers from renewable resources, *Nature*, 2016, **540**(7633), 354–362.
- 2 A. J. Silvestre and A. Gandini, Terpenes: major sources, properties and applications, in *Monomers, polymers and composites from renewable resources*, Elsevier, 2008, p. 17–38.
- 3 M. N. Belgacem and A. Gandini, *Monomers, polymers and composites from renewable resources*, Elsevier, 2011.
- 4 G. Fráter, J. A. Bajgrowicz and P. Kraft, *Fragrance chemistry, Tetrahedron*, 1998, **54**(27), 7633–7703.
- 5 M. F. M. G. Result, *et al.*, Continuous process for the epoxidation of terpenes using mesoscale oscillatory baffled reactors, *Chem. Eng. Process*, 2022, **177**, 108998.
- 6 Y. Mahamat Ahmat, *et al.*, Epoxidation of terpenes, *Catalysts*, 2021, **11**(7), 847.
- 7 L. Shen, E. Worrell and M. Patel, Present and future development in plastics from biomass, *Biofuel. Bioprod. Biorefin.*, 2010, **4**(1), 25–40.
- 8 P. T. Anastas and M. M. Kirchhoff, Origins, current status, and future challenges of green chemistry, *Accounts Chem. Res.*, 2002, **35**(9), 686–694.
- 9 R. A. Sheldon and M. Norton, Green chemistry and the plastic pollution challenge: towards a circular economy, *Green Chem.*, 2020, **22**(19), 6310–6322.
- 10 M. Stekrova, *et al.*, Isomerization of  $\alpha$ -pinene oxide using Fe-supported catalysts: selective synthesis of campholenic aldehyde, *Appl. Catal., A*, 2014, **470**, 162–176.
- 11 R. Geyer, J. R. Jambeck and K. L. Law, Production, use, and fate of all plastics ever made, *Sci. Adv.*, 2017, **3**(7), e1700782.
- 12 G. Yadav and D. Satoskar, Kinetics of epoxidation of alkyl esters of undecylenic acid: comparison of traditional routes vs. Ishii-Venturello chemistry, *J. Am. Oil Chem. Soc.*, 1997, **74**(4), 397–407.
- 13 P. Gallezot, Process options for converting renewable feedstocks to bioproducts, *Green Chem.*, 2007, **9**(4), 295–302.
- 14 E. Breitmaier, *Terpenes: flavors, fragrances, pharmaca, pheromones*, John Wiley & Sons, 2006.
- 15 A. Gandini, The irruption of polymers from renewable resources on the scene of macromolecular science and technology, *Green Chem.*, 2011, **13**(5), 1061–1083.
- 16 A. Llevot, *et al.*, Renewability is not enough: recent advances in the sustainable synthesis of biomass-derived monomers and polymers, *Chem.–Eur. J.*, 2016, **22**(33), 11510–11521.
- 17 M. R. Thomsett, *et al.*, Progress in the synthesis of sustainable polymers from terpenes and terpenoids, *Green Mater.*, 2016, **4**(3), 115–134.
- 18 M. Colonna, *et al.*, Synthesis and radiocarbon evidence of terephthalate polyesters completely prepared from renewable resources, *Green Chem.*, 2011, **13**(9), 2543–2548.
- 19 M. Firdaus, L. Montero de Espinosa and M. A. Meier, Terpene-based renewable monomers and polymers via thiol–ene additions, *Macromolecules*, 2011, **44**(18), 7253–7262.
- 20 P. Knuutila, Wood sulphate turpentine as a gasoline bio-component, *Fuel*, 2013, **104**, 101–108.
- 21 M. a. F. Gscheidmeier and H. Turpentines, in *Ullmann's Encyclopedia of Industrial Chemistry*, ed. M. a. F. Gscheidmeier, 2000.
- 22 R. Ciriminna, *et al.*, Limonene: a versatile chemical of the bioeconomy, *Chem. Commun.*, 2014, **50**(97), 15288–15296.
- 23 M. F. M. G. Result, *et al.*, Development of rapid and selective epoxidation of  $\alpha$ -pinene using single-step addition of H<sub>2</sub>O<sub>2</sub> in an organic solvent-free process, *RSC Adv.*, 2021, **11**(52), 33027–33035.
- 24 W. Erman, *Chemistry of monoterpenes. Part A. Edited by PG Gassmann*, Marcel Dekker, New York, 1985.
- 25 L. Vogli, *et al.*, Life cycle assessment and energy balance of a novel polyhydroxyalkanoates production process with mixed microbial cultures fed on pyrolytic products of wastewater treatment sludge, *Energies*, 2020, **13**(11), 2706.
- 26 J. C. Philp, *et al.*, Bioplastics science from a policy vantage point, *New Biotechnol.*, 2013, **30**(6), 635–646.
- 27 R. Albert, S. Traynor, and R. Webb, *Fragrance and flavor chemicals. Naval Store-Production, Chemistry, Utilization*, ed. D. F. Zinkel and J. Russell, PULP Chemical Association, New York, 1989, p. 479.
- 28 J. Derfer and S. Traynor, *Chemistry of Turpentine in Naval Stores: Production, Chemistry and Utilization*, New York, 1989.
- 29 J.-A. Becerra, L.-M. González and A.-L. Villa, A bio-inspired heterogeneous catalyst for the transformation of limonene from orange peel waste biomass into value-added products, *Catal. Today*, 2018, **302**, 250–260.
- 30 E. M. Garcia-Castello, *et al.*, Reverse osmosis concentration of press liquid from orange juice solid wastes: flux decline mechanisms, *J. Food Eng.*, 2011, **106**(3), 199–205.
- 31 L. D. Almeida, *et al.*, Catalytic aerobic epoxidation of bio-renewable alkenes using organic carbonates as green solvents, *Mol. Catal.*, 2022, **527**, 112400.
- 32 R. Wikandari, *et al.*, Improvement of biogas production from orange peel waste by leaching of limonene, *BioMed Res. Int.*, 2015, **2015**, 494182.
- 33 N. Fdil, *et al.*, Terpenic olefin epoxidation using metals acetylacetonates as catalysts, *J. Mol. Catal. A: Chem.*, 1996, **108**(1), 15–21.
- 34 H. Mimoun, Catalytic opportunities in the flavor and fragrance industry, *Chimia*, 1996, **50**(12), 620.





- 35 A. Calogirou, B. Larsen and D. Kotzias, Gas-phase terpene oxidation products: a review, *Atmos. Environ.*, 1999, **33**(9), 1423–1439.
- 36 C. Chapuis and D. Jacoby, Catalysis in the preparation of fragrances and flavours, *Appl. Catal., A*, 2001, **221**(1–2), 93–117.
- 37 K. Bauer, D. Garbe and H. Surburg, *Common fragrance and flavor materials: preparation, properties and uses*, John Wiley & Sons, 2008.
- 38 P. A. Wender and T. P. Mucciaro, A new and practical approach to the synthesis of taxol and taxol analogs: the pinene path, *J. Am. Chem. Soc.*, 1992, **114**(14), 5878–5879.
- 39 E. Juaristi and L. Paquette, *Handbook of Reagents for Organic Synthesis. Chiral Reagents for Asymmetric Synthesis*, Wiley, Chichester, 2003.
- 40 G. Sienel, R. Rieth and K. Rowbottom, *Ullmann's Encyclopedia of Industrial Chemistry*, Verlag Chemie, Weinheim, 2003.
- 41 J. Herzberger, *et al.*, Polymerization of ethylene oxide, propylene oxide, and other alkylene oxides: synthesis, novel polymer architectures, and bioconjugation, *Chem. Rev.*, 2016, **116**(4), 2170–2243.
- 42 D. Swern, *Organic Peroxides in Organic Peroxides*, ed. D. Swern, Wiley-Interscience, New York, 1971.
- 43 D. C. Duncan, *et al.*, Mechanism and dynamics in the H3 [PW12O40]-catalyzed selective epoxidation of terminal olefins by H2O2. Formation, reactivity, and stability of {PO4[WO(O)2]4}3, *J. Am. Chem. Soc.*, 1995, **117**(2), 681–691.
- 44 J. Kobe, *et al.*, *Epoxidation–Industrial. Encyclopedia of catalysis*, 2002.
- 45 K. Kamata, *et al.*, Efficient epoxidation of olefins with  $\geq 99\%$  selectivity and use of hydrogen peroxide, *Science*, 2003, **300**(5621), 964–966.
- 46 W. Zhong, *et al.*, Synergistic hollow CoMo oxide dual catalysis for tandem oxygen transfer: preferred aerobic epoxidation of cyclohexene to 1, 2-epoxycyclohexane, *Appl. Catal. B Environ.*, 2018, **225**, 180–196.
- 47 A. Pena, *et al.*, Limonene oxidation by molecular oxygen under solvent-free conditions: the influence of peroxides and catalysts on the reaction rate, *React. Kinet. Mech. Catal.*, 2012, **107**(2), 263–275.
- 48 Y. Ishii, S. Sakaguchi and T. Iwahama, Innovation of hydrocarbon oxidation with molecular oxygen and related reactions, *Adv. Synth. Catal.*, 2001, **343**(5), 393–427.
- 49 L. Vanoye, *et al.*, Epoxidation using molecular oxygen in flow: facts and questions on the mechanism of the Mukaiyama epoxidation, *Catal. Sci. Technol.*, 2016, **6**(13), 4724–4732.
- 50 S. Madadi, *et al.*, Aerobic epoxidation of limonene using cobalt substituted mesoporous SBA-16 Part 1: Optimization via Response Surface Methodology (RSM), *Appl. Catal. B Environ.*, 2020, **260**, 118049.
- 51 S. Madadi, J.-Y. Bergeron and S. Kaliaguine, Kinetic investigation of aerobic epoxidation of limonene over cobalt substituted mesoporous SBA-16, *Catal. Sci. Technol.*, 2021, **11**(2), 594–611.
- 52 S. Madadi and S. Kaliaguine, Activated carbon-supported ruthenium as a catalyst for the solvent-and initiator-free aerobic epoxidation of limonene, *ACS Sustain. Chem. Eng.*, 2021, **9**(31), 10557–10568.
- 53 M. V. Patil, M. K. Yadav and R. V. Jasra, Catalytic epoxidation of  $\alpha$ -pinene with molecular oxygen using cobalt (II)-exchanged zeolite Y-based heterogeneous catalysts, *J. Mol. Catal. A: Chem.*, 2007, **277**(1–2), 72–80.
- 54 Y. M. Ahmat and S. Kaliaguine, Epoxidation of limonene and pinenes by dimethyldioxirane in microemulsions, *Catal. Today*, 2023, **407**, 146–155.
- 55 F. Chiker, *et al.*, Green and selective epoxidation of alkenes catalysed by new TiO<sub>2</sub>-SiO<sub>2</sub> SBA mesoporous solids, *Green Chem.*, 2003, **5**(3), 318–322.
- 56 S. Casuscelli, *et al.*, Effect of reaction conditions on limonene epoxidation with H2O2 catalyzed by supported Keggin heteropolycompounds, *Appl. Catal., A*, 2004, **274**(1–2), 115–122.
- 57 S. Casuscelli, *et al.*, Application of complex heteropolytungstates in limonene epoxidation by H2O2 in biphasic medium, *Catal. Today*, 2005, **107**, 230–234.
- 58 J. M. d. S. e Silva, *et al.*, The chemical reactivity of some terpenes investigated by alumina catalyzed epoxidation with hydrogen peroxide and by DFT calculations, *J. Mol. Catal. A: Chem.*, 2006, **252**(1–2), 186–193.
- 59 R. Barrera Zapata, A. L. Villa and C. Montes de Correa, Kinetic modeling of limonene epoxidation over PW-Amberlite, *Ind. Eng. Chem. Res.*, 2009, **48**(2), 647–653.
- 60 A. L. Cánepa, *et al.*, H2O2 based  $\alpha$ -pinene oxidation over Ti-MCM-41. A kinetic study, *J. Mol. Catal. A: Chem.*, 2011, **347**(1–2), 1–7.
- 61 Y. Kon, *et al.*, An effective synthesis of acid-sensitive epoxides via oxidation of terpenes and styrenes using hydrogen peroxide under organic solvent-free conditions, *Synthesis*, 2011, **2011**(7), 1092–1098.
- 62 M. G. Egusquiza, *et al.*, Advance in the study of limonene epoxidation with H2O2 catalyzed by Cu (II) complex heteropolytungstates, *Catal. Commun.*, 2012, **26**, 117–121.
- 63 T. Michel, *et al.*, Selective epoxidation of (+)-limonene employing methyltrioxorhenium as catalyst, *J. Mol. Catal. A: Chem.*, 2012, **358**, 159–165.
- 64 M. Zheng, *et al.*, Oxidation of  $\alpha$ -Pinene with Hydrogen Peroxide Catalyzed by VO(OAc)<sub>2</sub>, in *Advanced Materials Research*, Trans Tech Publ, 2012.
- 65 A. J. Bonon, *et al.*, Limonene epoxidation with H2O2 promoted by Al2O3: Kinetic study, experimental design, *J. Catal.*, 2014, **319**, 71–86.
- 66 J.-P. Schirmann and S. Y. Delavarenne, *Hydrogen peroxide in organic chemistry*, 1981, Edition et documentation industrielle.
- 67 G. Strukul, *Catalytic oxidations with hydrogen peroxide as oxidant*, Springer Science & Business Media, 2013, vol. 9.
- 68 C. W. Jones, *Applications of hydrogen peroxide and derivatives*, Royal Society of Chemistry, 1999, vol. 2.
- 69 M. Cagnoli, *et al.*, “Clean” limonene epoxidation using Ti-MCM-41 catalyst, *Appl. Catal., A*, 2005, **287**(2), 227–235.





- 70 A. L. Cánepa, *et al.*, Biomass toward fine chemical products: oxidation of  $\alpha$ -pinene over sieves nanostructured modified with vanadium, *J. Mol. Catal. A: Chem.*, 2015, **404**, 65–73.
- 71 C. Venturello, E. Alneri and M. Ricci, A new, effective catalytic system for epoxidation of olefins by hydrogen peroxide under phase-transfer conditions, *J. Org. Chem.*, 1983, **48**(21), 3831–3833.
- 72 A. Jimtaisong and R. L. Luck, Synthesis and Catalytic Epoxidation Activity with TBHP and H<sub>2</sub>O<sub>2</sub> of Dioxo-, Oxoperoxo-, and Oxodiperoxo Molybdenum (VI) and Tungsten (VI) Compounds Containing Monodentate or Bidentate Phosphine Oxide Ligands: Crystal Structures of WCl<sub>2</sub>(O)<sub>2</sub>(OPMePh<sub>2</sub>)<sub>2</sub>, WCl<sub>2</sub>(O)(O<sub>2</sub>)(OPMePh<sub>2</sub>)<sub>2</sub>, MoCl<sub>2</sub>(O)<sub>2</sub>dppmO<sub>2</sub>·C<sub>4</sub>H<sub>10</sub>O, WCl<sub>2</sub>(O)<sub>2</sub>dppmO<sub>2</sub>, Mo(O)(O<sub>2</sub>)<sub>2</sub>dppmO<sub>2</sub>, and W(O)(O<sub>2</sub>)<sub>2</sub>dppmO<sub>2</sub>, *Inorg. Chem.*, 2006, **45**(25), 10391–10402.
- 73 Y. Ishii, *et al.*, Hydrogen peroxide oxidation catalyzed by heteropoly acids combined with cetylpyridinium chloride. Epoxidation of olefins and allylic alcohols, ketonization of alcohols and diols, and oxidative cleavage of 1, 2-diols and olefins, *J. Org. Chem.*, 1988, **53**(15), 3587–3593.
- 74 C. Venturello and R. D'Aloisio, Quaternary ammonium tetrakis (diperoxotungsto) phosphates (3-) as a new class of catalysts for efficient alkene epoxidation with hydrogen peroxide, *J. Org. Chem.*, 1988, **53**(7), 1553–1557.
- 75 R. Noyori, M. Aoki and K. Sato, Green oxidation with aqueous hydrogen peroxide, *Chem. Commun.*, 2003, (16), 1977–1986.
- 76 G. Grigoropoulou, J. Clark and J. Elings, Recent developments on the epoxidation of alkenes using hydrogen peroxide as an oxidant, *Green Chem.*, 2003, **5**(1), 1–7.
- 77 K. Takumi, N. Sasagawa, Y. Ezaki, K. O. N. Yoshihiro, Y. Ono and K. Sato, *US Pat.*, 8,742,145, US Patent and Trademark Office, Washington, DC, 2014.
- 78 H. Hachiya, *et al.*, Unique Salt Effect on Highly Selective Synthesis of Acid-Labile Terpene and Styrene Oxides with a Tungsten/H<sub>2</sub>O<sub>2</sub> Catalytic System under Acidic Aqueous Conditions, *Synthesis*, 2012, **44**(11), 1672–1678.
- 79 P. U. Maheswari, *et al.*, A Na<sub>2</sub>WO<sub>4</sub>/H<sub>2</sub>WO<sub>4</sub>-Based Highly Efficient Biphasic Catalyst towards Alkene Epoxidation, using Dihydrogen Peroxide as Oxidant, *Adv. Synth. Catal.*, 2005, **347**(14), 1759–1764.
- 80 D. Kaur, *et al.*, Epoxidation studies of terpenes with urea hydrogen peroxide and phosphotungstic acid, *Indian J. Chem.*, 2010, **49**(5), 598–603.
- 81 L. Charbonneau and S. Kaliaguine, Epoxidation of limonene over low coordination Ti in Ti-SBA-16, *Appl. Catal., A*, 2017, **533**, 1–8.
- 82 A. Wróblewska, The epoxidation of limonene over the TS-1 and Ti-SBA-15 catalysts, *Molecules*, 2014, **19**(12), 19907–19922.
- 83 U. Neuenschwander, F. Guignard and I. Hermans, Mechanism of the Aerobic Oxidation of  $\alpha$ -Pinene, *ChemSusChem*, 2010, **3**(1), 75–84.
- 84 U. Neuenschwander, E. Meier and I. Hermans, Peculiarities of  $\beta$ -Pinene Autoxidation, *ChemSusChem*, 2011, **4**(11), 1613–1621.
- 85 K. A. Swift, Catalytic transformations of the major terpene feedstocks, *Top. Catal.*, 2004, **27**(1), 143–155.
- 86 A. Corma, S. Iborra and A. Velty, Chemical routes for the transformation of biomass into chemicals, *Chem. Rev.*, 2007, **107**(6), 2411–2502.
- 87 G. Carr, *et al.*, Ring opening of  $\alpha$ -pinene epoxide, *J. Chem. Soc., Perkin Trans. 2*, 1994, (7), 1419–1422.
- 88 V. C. Eze, *et al.*, Synthesis of cyclic  $\alpha$ -pinane carbonate—a potential monomer for bio-based polymers, *RSC Adv.*, 2022, **12**(27), 17454–17465.
- 89 J. F. Mata-Segreda, Hydroxide as general base in the saponification of ethyl acetate, *J. Am. Chem. Soc.*, 2002, **124**(10), 2259–2262.
- 90 V. Theodorou, *et al.*, A simple method for the alkaline hydrolysis of esters, *Tetrahedron Lett.*, 2007, **48**(46), 8230–8233.
- 91 N. Prileschajew, Oxydation ungesättigter Verbindungen mittels organischer Superoxyde, *Berichte der deutschen chemischen Gesellschaft*, **42**(4), 4811–4815.
- 92 M.-Y. Yao, *et al.*, Highly efficient silica-supported peroxycarboxylic acid for the epoxidation of unsaturated fatty acid methyl esters and vegetable oils, *ACS Sustain. Chem. Eng.*, 2016, **4**(7), 3840–3849.
- 93 V. V. Goud, *et al.*, Kinetics of epoxidation of jatropha oil with peroxyacetic and peroxyformic acid catalysed by acidic ion exchange resin, *Chem. Eng. Sci.*, 2007, **62**(15), 4065–4076.
- 94 G. Grigoropoulou and J. H. Clark, A catalytic, environmentally benign method for the epoxidation of unsaturated terpenes with hydrogen peroxide, *Tetrahedron Lett.*, 2006, **47**(26), 4461–4463.
- 95 G. Yadav and A. Pujari, Epoxidation of Styrene to Styrene Oxide: Synergism of Heteropoly Acid and Phase-Transfer Catalyst under Ishii–Venturello Mechanism, *Org. Process Res. Dev.*, 2000, **4**(2), 88–93.
- 96 L. Charbonneau, *et al.*, Catalyst-free epoxidation of limonene to limonene dioxide, *ACS Sustain. Chem. Eng.*, 2018, **6**(4), 5115–5121.
- 97 W. B. Cunningham, *et al.*, Sustainable catalytic protocols for the solvent free epoxidation and anti-dihydroxylation of the alkene bonds of biorenewable terpene feedstocks using H<sub>2</sub>O<sub>2</sub> as oxidant, *Green Chem.*, 2020, **22**(2), 513–524.
- 98 M. Guidotti, *et al.*, Heterogeneous Catalytic Epoxidation: High Limonene Oxide Yields by Surface Silylation of Ti-MCM-41, *Chem. Eng. Technol.*, 2011, **34**(11), 1924–1927.
- 99 D. E. Katsoulis, A survey of applications of polyoxometalates, *Chem. Rev.*, 1998, **98**(1), 359–388.
- 100 C. L. Hill, Progress and challenges in polyoxometalate-based catalysis and catalytic materials chemistry, *J. Mol. Catal. A: Chem.*, 2007, **262**(1–2), 2–6.
- 101 F. Cavani, Heteropolycompound-based catalysts: a blend of acid and oxidizing properties, *Catal. Today*, 1998, **41**(1–3), 73–86.



- 102 Z. Zhu, R. Tain and C. Rhodes, A study of the decomposition behaviour of 12-tungstophosphate heteropolyacid in solution, *Can. J. Chem.*, 2003, **81**(10), 1044–1050.
- 103 N. Mizuno and M. Misono, Heterogeneous catalysis, *Chem. Rev.*, 1998, **98**(1), 199–218.
- 104 C. L. Hill, Introduction: polyoxometalates multicomponent molecular vehicles to probe fundamental issues and practical problems, *Chem. Rev.*, 1998, **98**(1), 1–2.
- 105 B. Dutta, *et al.*,  $\gamma$ -Fe<sub>2</sub>O<sub>3</sub> nanoparticle in NaY-zeolite matrix: preparation, characterization, and heterogeneous catalytic epoxidation of olefins, *Inorg. Chim. Acta*, 2010, **363**(4), 696–704.
- 106 K. C. Gupta, A. K. Sutar and C.-C. Lin, Polymer-supported Schiff base complexes in oxidation reactions, *Coord. Chem. Rev.*, 2009, **253**(13–14), 1926–1946.
- 107 D. E. De Vos, B. F. Sels and P. A. Jacobs, Practical heterogeneous catalysts for epoxide production, *Adv. Synth. Catal.*, 2003, **345**(4), 457–473.
- 108 A. Di Giuseppe, *et al.*, Chitin-and chitosan-anchored methyltrioxorhenium: an innovative approach for selective heterogeneous catalytic epoxidations of olefins, *J. Catal.*, 2010, **276**(2), 412–422.
- 109 M. Amini, M. M. Haghdoost and M. Bagherzadeh, Monomeric and dimeric oxido-peroxido tungsten (VI) complexes in catalytic and stoichiometric epoxidation, *Coord. Chem. Rev.*, 2014, **268**, 83–100.
- 110 B. S. Lane and K. Burgess, Metal-catalyzed epoxidations of alkenes with hydrogen peroxide, *Chem. Rev.*, 2003, **103**(7), 2457–2474.
- 111 M. Uguina, *et al.*, Alumina as heterogeneous catalyst for the regioselective epoxidation of terpenic diolefins with hydrogen peroxide, *J. Mol. Catal. A: Chem.*, 2006, **256**(1–2), 208–215.
- 112 S. T. Oyama, Rates, kinetics, and mechanisms of epoxidation: homogeneous, heterogeneous, and biological routes, in *Mechanisms in homogeneous and heterogeneous epoxidation catalysis*, Elsevier, 2008, pp. 3–99.
- 113 I. Arends and R. Sheldon, Recent developments in selective catalytic epoxidations with H<sub>2</sub>O<sub>2</sub>, *Top. Catal.*, 2002, **19**(1), 133–141.
- 114 A. Mouret, *et al.*, Eco-friendly solvents and amphiphilic catalytic polyoxometalate nanoparticles: a winning combination for olefin epoxidation, *Green Chem.*, 2014, **16**(1), 269–278.
- 115 C. Palumbo, *et al.*, An efficient epoxidation of terminal aliphatic alkenes over heterogeneous catalysts: when solvent matters, *Catal. Sci. Technol.*, 2016, **6**(11), 3832–3839.
- 116 N. Mizuno, K. Yamaguchi and K. Kamata, Epoxidation of olefins with hydrogen peroxide catalyzed by polyoxometalates, *Coord. Chem. Rev.*, 2005, **249**(17–18), 1944–1956.
- 117 E. Wiebus and B. Cornils, *Biphasic Systems: Water—Organic, in Catalyst Separation, Recovery and Recycling*, Springer, 2006, pp. 105–143.
- 118 C. Rabeyrin and D. Sinou, Catalytic asymmetric alkylation in water in the presence of surfactants: influence of the nature of the nucleophile and the allylic acetate on the activity and enantioselectivity, *Tetrahedron: Asymmetry*, 2003, **14**(24), 3891–3897.
- 119 R. G. da Rosa, J. D. R. de Campos and R. Buffon, The effect of water on the rhodium-catalyzed carbonylation of isopropylallylamine, *J. Mol. Catal. A: Chem.*, 2000, **153**(1–2), 19–24.
- 120 C. Loncaric, K. Manabe and S. Kobayashi, AgOTf-Catalyzed Aza-Diels–Alder Reactions of Danishefsky's Diene with Imines in Water, *Adv. Synth. Catal.*, 2003, **345**(4), 475–477.
- 121 Z. Yang, M. Ebihara and T. Kawamura, Homogeneous hydrogenation of olefins catalyzed by a novel tetra-rhodium (II) complex as precursor in aqueous solution, *J. Mol. Catal. A: Chem.*, 2000, **158**(2), 509–514.
- 122 E. Duynstee and E. Grunwald, Organic reactions occurring in or on micelles. I. Reaction rate studies of the alkaline fading of triphenylmethane dyes and sulfonphthalein indicators in the presence of detergent salts<sup>1</sup>, *J. Am. Chem. Soc.*, 1959, **81**(17), 4540–4542.
- 123 K. Letts and R. Mackay, Reactions in microemulsions. I. Metal ion incorporation by tetraphenylporphine, *Inorg. Chem.*, 1975, **14**(12), 2990–2993.
- 124 W. P. Weber and G. W. Gokel, Reactions of Dichlorocarbene With Non-Olefinic Substrates, in *Phase Transfer Catalysis in Organic Synthesis*, Springer, 1977, pp. 44–57.
- 125 Y. Chen, *et al.*, On the nature of reaction-controlled phase transfer catalysts for epoxidation of olefin: a <sup>31</sup>P NMR investigation, *Catal. Lett.*, 2004, **93**(1), 41–46.
- 126 X. Yang, S. Gao and Z. Xi, Reaction-controlled phase transfer catalysis for styrene epoxidation to styrene oxide with aqueous hydrogen peroxide, *Org. Process Res. Dev.*, 2005, **9**(3), 294–296.
- 127 K. Holmberg, Organic reactions in microemulsions, *Eur. J. Org. Chem.*, 2007, **2007**(5), 731–742.
- 128 F. Menger and A. Elrington, Organic reactivity in microemulsion systems, *J. Am. Chem. Soc.*, 1991, **113**(25), 9621–9624.
- 129 C. de Bellefon, *et al.*, Microreactors for dynamic, high throughput screening of fluid/liquid molecular catalysis, *Angew. Chem.*, 2000, **112**(19), 3584–3587.
- 130 d. P. Villa, A. Taborda and d. C. C. Montes, Kinetics of limonene epoxidation by hydrogen peroxide on PW-Amberlite, *J. Mol. Catal. A: Chem.*, 2002, **185**(1–2), 269–277.
- 131 J. E. Hunter and J. F. Fowler Jr, Safety to human skin of cocamidopropyl betaine: a mild surfactant for personal-care products, *J. Surfactants Deterg.*, 1998, **1**(2), 235–239.
- 132 Y. Mahha, *et al.*, Environmentally friendly epoxidation of olefins under phase-transfer catalysis conditions with hydrogen peroxide, *J. Catal.*, 2007, **249**(2), 338–348.
- 133 M.-L. Wang and V. Rajendran, Ultrasound assisted phase-transfer catalytic epoxidation of 1, 7-octadiene—A kinetic study, *Ultrason. Sonochem.*, 2007, **14**(1), 46–54.
- 134 T. Seki and A. Baiker, Catalytic oxidations in dense carbon dioxide, *Chem. Rev.*, 2009, **109**(6), 2409–2454.



- 135 D. C. Albanese, F. Foschi and M. Penso, Sustainable oxidations under phase-transfer catalysis conditions, *Org. Process Res. Dev.*, 2016, **20**(2), 129–139.
- 136 C. M. Starks, Phase-transfer catalysis. I. Heterogeneous reactions involving anion transfer by quaternary ammonium and phosphonium salts, *J. Am. Chem. Soc.*, 1971, **93**(1), 195–199.
- 137 W. P. Weber and G. W. Gokel, Altered Reactivity, in *Phase Transfer Catalysis in Organic Synthesis*, Springer, 1977, pp. 242–251.
- 138 M. Makosza, Phase-transfer catalysis. A general green methodology in organic synthesis, *Pure Appl. Chem.*, 2000, **72**(7), 1399–1403.
- 139 E. Murugan and A. Siva, Preparation of a novel soluble multi-site phase transfer catalyst and the kinetic study for the C-alkylation of  $\alpha$ -pinene, *J. Mol. Catal. A: Chem.*, 2005, **235**(1–2), 220–229.
- 140 R.-a. Doong, Y.-W. Wu and W.-g. Lei, Surfactant enhanced remediation of cadmium contaminated soils, *Water Sci. Technol.*, 1998, **37**(8), 65–71.
- 141 S. D. Bishopp, J. L. Scott and L. Torrente-Murciano, Insights into biphasic oxidations with hydrogen peroxide; towards scaling up, *Green Chem.*, 2014, **16**(6), 3281–3285.
- 142 C. D. Vecitis, *et al.*, Kinetics and mechanism of the sonolytic conversion of the aqueous perfluorinated surfactants, perfluorooctanoate (PFOA), and perfluorooctane sulfonate (PFOS) into inorganic products, *J. Phys. Chem. A*, 2008, **112**(18), 4261–4270.
- 143 L.-M. Wang, *et al.*, Sodium stearate-catalyzed multicomponent reactions for efficient synthesis of spirooxindoles in aqueous micellar media, *Tetrahedron*, 2010, **66**(1), 339–343.
- 144 D. G. Lee and V. S. Chang, Oxidation of hydrocarbons. 8. Use of dimethyl polyethylene glycol as a phase transfer agent for the oxidation of alkenes by potassium permanganate, *J. Org. Chem.*, 1978, **43**(8), 1532–1536.
- 145 D. Attwood, C. Mallon and C. Taylor, Phase studies on oil-in-water phospholipid microemulsions, *Int. J. Pharm.*, 1992, **84**(2), R5–R8.
- 146 Y. Kimura, P. Kirszensztejn and S. L. Regen, Poly(ethylene glycol)-graft copolymers as synthetic equivalents of benzyltriethylammonium chloride for triphase catalytic alkylation, *J. Org. Chem.*, 1983, **48**(3), 385–386.
- 147 R. Neumann and M. Gara, Highly active manganese-containing polyoxometalate as catalyst for epoxidation of alkenes with hydrogen peroxide, *J. Am. Chem. Soc.*, 1994, **116**(12), 5509–5510.
- 148 S. Desikan and L. Doraiswamy, Enhanced activity of polymer-supported phase transfer catalysts, *Chem. Eng. Sci.*, 2000, **55**(24), 6119–6127.
- 149 J.-Y. Piquemal, C. Bois and J.-M. Brégeault, Synthesis, reactivity, X-ray crystal and molecular structures of a novel dimeric tungsten (vi) polyoxoperoxo complex: [PPh<sub>4</sub>]<sub>2</sub>[Ph<sub>2</sub>SiO<sub>2</sub>{W<sub>2</sub>O<sub>2</sub>( $\mu$ -O<sub>2</sub>)<sub>2</sub>(O<sub>2</sub>)<sub>2</sub>}] and of a molybdenum (vi) analogue, *Chem. Commun.*, 1997, (5), 473–474.
- 150 J. Gao, *et al.*, A spectroscopic study on the reaction-controlled phase transfer catalyst in the epoxidation of cyclohexene, *J. Mol. Catal. A: Chem.*, 2004, **210**(1–2), 197–204.
- 151 A. M. Hyde, *et al.*, General principles and strategies for salting-out informed by the Hofmeister series, *Org. Process Res. Dev.*, 2017, **21**(9), 1355–1370.
- 152 A. Campanella and M. A. Baltanás, Degradation of the oxirane ring of epoxidized vegetable oils in liquid–liquid heterogeneous reaction systems, *Chem. Eng. J.*, 2006, **118**(3), 141–152.
- 153 M. Randall and C. F. Failey, The Activity Coefficient of Non-Electrolytes in Aqueous Salt Solutions from Solubility Measurements. The Salting-out Order of the Ions, *Chem. Rev.*, 1927, **4**(3), 285–290.
- 154 F. Auremma, *et al.*, Stereocomplexed poly(limonene carbonate): a unique example of the cocrystallization of amorphous enantiomeric polymers, *Angew. Chem.*, 2015, **127**(4), 1231–1234.
- 155 O. Hauenstein, *et al.*, Bio-based polycarbonate from limonene oxide and CO<sub>2</sub> with high molecular weight, excellent thermal resistance, hardness and transparency, *Green Chem.*, 2016, **18**(3), 760–770.
- 156 F. Parrino, *et al.*, Polymers of limonene oxide and carbon dioxide: polycarbonates of the solar economy, *ACS Omega*, 2018, **3**(5), 4884–4890.
- 157 A. Rehman, *et al.*, Highly selective, sustainable synthesis of limonene cyclic carbonate from bio-based limonene oxide and CO<sub>2</sub>: a kinetic study, *J. CO<sub>2</sub> Util.*, 2019, **29**, 126–133.
- 158 N. G. Anderson, Practical use of continuous processing in developing and scaling up laboratory processes, *Org. Process Res. Dev.*, 2001, **5**(6), 613–621.
- 159 T. Illg, P. Löb and V. Hessel, Flow chemistry using milli- and microstructured reactors—From conventional to novel process windows, *Bioorg. Med. Chem.*, 2010, **18**(11), 3707–3719.
- 160 S. G. Newman and K. F. Jensen, The role of flow in green chemistry and engineering, *Green Chem.*, 2013, **15**(6), 1456–1472.
- 161 M. Colombo and I. Peretto, Chemistry strategies in early drug discovery: an overview of recent trends, *Drug discovery today*, 2008, **13**(15–16), 677–684.
- 162 N. G. Anderson, *et al.*, *Org. Process Res. Dev.*, 2012, **16**, 852–869.
- 163 S. Ranganathan and V. Sieber, Development of semi-continuous chemo-enzymatic terpene epoxidation: combination of anthraquinone autooxidation and the lipase-mediated epoxidation process, *React. Chem. Eng.*, 2017, **2**(6), 885–895.
- 164 X. Zhang, S. Stefanick and F. J. Villani, Application of microreactor technology in process development, *Org. Process Res. Dev.*, 2004, **8**(3), 455–460.
- 165 B. P. Mason, *et al.*, Greener approaches to organic synthesis using microreactor technology, *Chem. Rev.*, 2007, **107**(6), 2300–2318.
- 166 J. D. Tibbetts, *et al.*, Sustainable catalytic epoxidation of biorenewable terpene feedstocks using H<sub>2</sub>O<sub>2</sub> as an



## Review

- oxidant in flow microreactors, *Green Chem.*, 2021, **23**(15), 5449–5455.
- 167 G. d. S. Botas, *et al.*, Baccharis reticularia DC and limonene nanoemulsions: promising larvicidal agents for Aedes aegypti (Diptera: Culicidae) control, *Molecules*, 2017, **22**(11), 1990.
- 168 K. Kamata, *et al.*, Efficient stereo- and regioselective hydroxylation of alkanes catalysed by a bulky polyoxometalate, *Nat. Chem.*, 2010, **2**(6), 478–483.
- 169 B. G. Donoeva, *et al.*, Epoxidation of Alkenes with H<sub>2</sub>O<sub>2</sub> Catalyzed by Ditungstenium-Containing 19-Tungstodarsenate (III): Experimental and Theoretical Studies, Wiley Online Library, 2010.
- 170 Y. Ding, *et al.*, [π-C<sub>5</sub>H<sub>5</sub>N(CH<sub>2</sub>)<sub>15</sub>CH<sub>3</sub>]<sub>3</sub>[PW<sub>4</sub>O<sub>32</sub>]/H<sub>2</sub>O<sub>2</sub>/ethyl acetate/alkenes: a recyclable and environmentally benign alkenes epoxidation catalytic system, *Green Chem.*, 2008, **10**(9), 910–913.
- 171 P. U. Maheswari, *et al.*, The role of carboxylic acids on a Na<sub>2</sub>WO<sub>4</sub>/H<sub>2</sub>WO<sub>4</sub>-based biphasic homogeneous alkene epoxidation, using H<sub>2</sub>O<sub>2</sub> as oxidant, *J. Mol. Catal. A: Chem.*, 2006, **258**(1–2), 295–301.

