

Transition metal-catalyzed decarboxylative coupling reactions of alkynyl carboxylic acids

Cite this: *RSC Advances*, 2013, 3, 14165

Kyungho Park and Sunwoo Lee*

The decarboxylative coupling of alkynyl carboxylic acids is an attractive area of research in organic chemistry, because the structure of aryl alkyne is one of the important building blocks for the synthesis of p-conjugated compounds. The use of alkynyl carboxylic acid as an alkyne source has several advantages in handling and storage. As a catalyst, palladium, copper, nickel, and silver were employed in the decarboxylative coupling reactions. The formation of C–C (sp²–sp, sp–sp and sp³–sp), C–N, C–P and C–S bonds has been developed. This review aims to illustrate the development of the decarboxylative coupling reaction of alkynyl carboxylic acids.

Received 24th March 2013,
Accepted 31st May 2013

DOI: 10.1039/c3ra41442f

www.rsc.org/advances

1 Introduction

Palladium-catalyzed cross coupling reactions are some of the most useful tools in the synthesis of important molecules, such as natural products, bioactive compounds, polymers, and materials.¹ Many types of reactions have been reported and widely used, such as the Kumada, Negishi, Stille, Suzuki, Hiyama, Heck, Sonogashira, and Buchwald–Hartwig coupling reactions.² The first five of these reactions consist of the coupling reaction of aryl halides (or pseudo halides) and organometallic compounds bearing Mg, Al, Zn, Sn, B, and Si.

These coupling partners have to be prepared from their corresponding simple arenes starting step processes for preparation,³ some of which may be hydrolytically sensitive and hence a limited range of starting materials can be used. Particularly, organometallic reagents require multi-functional group tolerance. To overcome this drawback, direct C–H activated coupling reactions have received much attention. Several catalysts have been used, including palladium, ruthenium, rhodium, copper, and others.⁴ However, these C–H activation methods have shown a narrow scope of substrates, having been limited to those which bear active protons by directing groups or low pK_a values, despite the development of new methodology to address this issue. Compared with the traditional cross-couplings and C–H activation, decarboxylative coupling reactions using carboxylic

Department of Chemistry, Chonnam National University, Gwangju, 500-757, Republic of Korea. E-mail: sunwoo@chonnam.ac.kr; Fax: 82 62 530 3389; Tel: 82 62 530 0264



Kyungho Park

Kyungho Park was born in Jangheung, South Korea in 1984. He obtained his B. S. from Chonnam National University in 2009. After completed his M. S. (2011) from the Department of Chemistry at the same university, he commenced his Ph. D. under supervision of Prof. Sunwoo Lee in the same university. And he had short term research experience in Prof. Carsten Bolm group (RWTH Aachen University) for the NRF(Korea)-DAAD(German) summer research program (7th July–29th August 2011). His research interests include development of decarboxylative coupling reactions and their application in the synthesis of advanced functional materials.



Sunwoo Lee

Sunwoo Lee was born in Busan, South Korea in 1969. After his B.S. in Chemistry Education at Pusan National University (1987–94, including military service), he obtained his M.S. (1996) and Ph. D. (1999) at POSTECH under the supervision of Professor Jaiwook Park. He did his post-doctoral studies in the Department of Chemistry at Yale University (1999–2001) with Professor John F. Hartwig. He worked at LG Chem as a senior researcher (2001–2004). In 2004, he began his current position as a Professor in the Department of Chemistry at Chonnam National University. The main focus of his work is the development of catalytic transformations and their applications.

acid derivatives have several advantages. Instead of metal waste from organometallic coupling reagents, less toxic carbon dioxide is released as a byproduct after the complete conversion, which reduces the cost of the process for the treatment of waste. In addition, carboxylic acid derivatives are easily available and stable for the handling and storage.

Decarboxylative coupling was first reported by Nilsson in 1966.⁵ However, it had not been cited until the early 2000s, because it was not practical due to its low yield, limited scope, and requirement of large amounts of Cu₂O. In 2002, Myers reported on palladium-catalyzed decarboxylative Heck reactions.⁶ Four years later, in 2006, Goossen developed efficient palladium-catalyzed decarboxylative coupling for the synthesis of biaryl from aryl carboxylic acids with aryl halides.⁷ Since then, a variety of related methodologies have been reported.⁸ In 2008, we first reported the decarboxylative coupling reaction of alkynyl carboxylic acid and aryl halides using a palladium catalyst, which afforded an efficient tool for the synthesis of symmetric and unsymmetric diarylalkynes.⁹ The use of alkynyl carboxylic acids as terminal alkyne surrogates provides a useful method for the handling of alkynes with a low boiling point.

Goossen^{8a} and Liu^{8b} independently reviewed the decarboxylative coupling reactions, including aryl carboxylic acids and some aryl alkynyl carboxylic acids. In this review, we focus on the decarboxylative coupling reactions of alkynyl carboxylic acid and recent related reports.

2 Palladium catalyzed-decarboxylative couplings

2.1. Coupling reactions with aryl halides and pseudo halides

The first decarboxylative coupling of alkynyl carboxylic acids was reported by S. Lee.⁹ They employed propiolic acid as an alkyne source for the coupling with aryl iodides and bromides with palladium catalyst in the presence of tetrabutylammonium fluoride (TBAF) (Scheme 1). While controlling the temperature, unsymmetric diarylalkynes were successfully obtained by one-pot reaction. However, this first report had some drawbacks, in that 6 equivalents of TBAF were required for high products yields, and 40 mol% *Pt*-Bu₃, which is

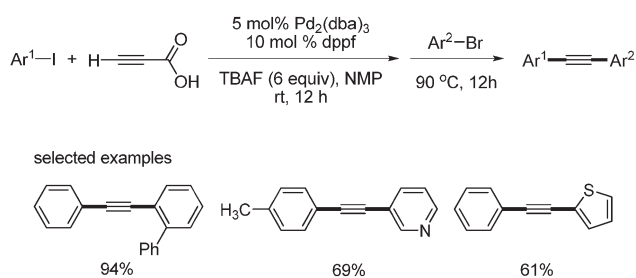

Scheme 1 Synthesis of unsymmetric diarylalkynes from propiolic acid and aryl halides.

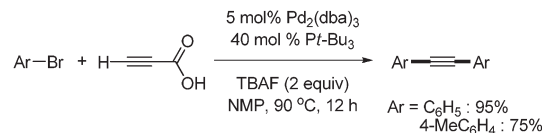

Scheme 2 Synthesis of symmetric diarylalkynes from propiolic acid and aryl halides.

sensitive to air and moisture, was used for the synthesis of symmetric diarylalkynes from aryl bromides (Scheme 2).

One year later, S. Lee applied the decarboxylative coupling reactions toward 2-octynoic acid and phenylpropionic acid.¹⁰ A variety of aryl bromides were coupled with alkynyl carboxylic acids, which afforded the desired aryl alkynes in good yields. In the case of 2-octynoic acid, Pd(PPh₃)₂Cl₂ (1 mol%) and 1,4-bis(diphenylphosphino)butane (dppb) (2 mol%) showed good results in DMSO. Phenylpropionic acid required Pd₂(dba)₃ (2.5 mol%) and *Pt*-Bu₃ (10 mol%) for good yield. Aryl bromides bearing ester and ketone groups and heteroaromatic halides afforded the desired coupled products in good yields. In addition, chloro group could survive in these conditions (Scheme 3). However, both systems still required 2 equivalents of TBAF.

In 2009, P. H. Lee reported the decarboxylative coupling reaction of phenylpropionic acid with a variety of coupling partners, such as aryl iodides, aryl bromides, aryl triflates, vinyl bromides, and vinyl triflates.¹¹ In the coupling with aryl iodides, the catalytic system of Pd₂(dba)₃·CHCl₃ (2 mol%) and PPh₃ (16 mol%) was used with Ag₂O (1 equiv.) and LiI (3 equiv.) in DMF. Aryl iodides with aldehyde showed 85% yield in the coupling reaction. Sterically demanding *ortho*-substituted aryl iodides also provided good yields of the products (Scheme 4). In the case of aryl bromides and triflates, Xantphos (8 mol%) and LiCl were employed instead of PPh₃ and LiI, respectively. α - and β -bromo styrene afforded the

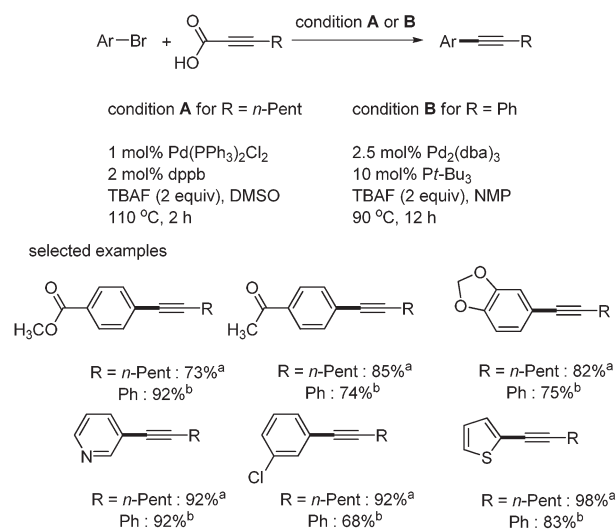

Scheme 3 Decarboxylative coupling with aryl bromides; ^acondition A; ^bcondition B.

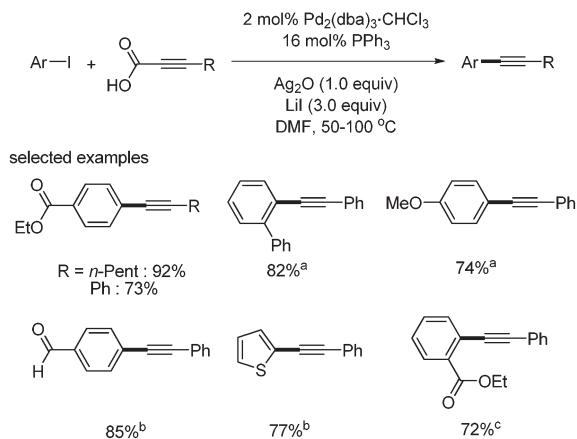

Scheme 4 Decarboxylative coupling with aryl iodides, ^a2 equiv. of Ag₂O, 2 equiv. of phenylpropionic acid and 6 equiv. of LiI were used, ^b8 mol% of Xantphos as a ligand, ^c1.5 equiv. of Ag₂O and phenylpropionic acid were used.

desired coupled product in 89% and 92% yields, respectively (Scheme 5).

As shown in Scheme 6, lithium phenylacetylide afforded the desired product in 35% yield, and silver phenylacetylide showed 51% yield. On the basis of these results, it was suggested that silver phenylacetylide might be involved in the transmetalation step rather than lithium phenylacetylide.

Li expanded the scope of substrates in palladium-catalyzed decarboxylative coupling reactions.¹² They developed a catalytic system consisting of Pd(OAc)₂ and XPhos, and ran the coupling reaction in the presence of Cs₂CO₃ in THF. A variety

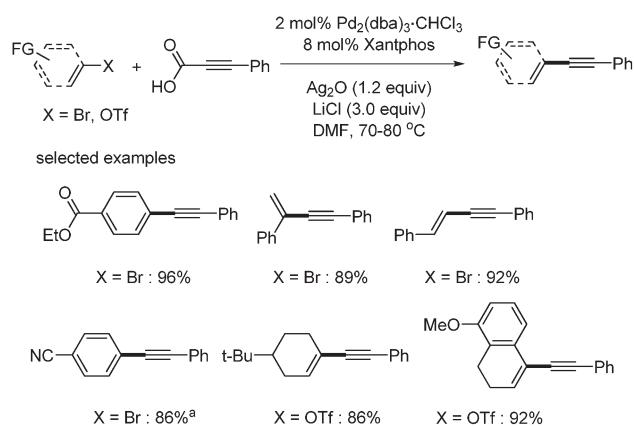

Scheme 5 Decarboxylative coupling with aryl and vinyl bromides and triflates. ^aLiI was used.

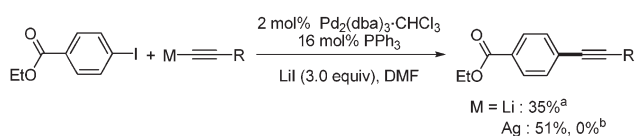

Scheme 6 Decarboxylative coupling with metal phenylacetylides. ^aTHF as solvent; ^babsence of LiI.

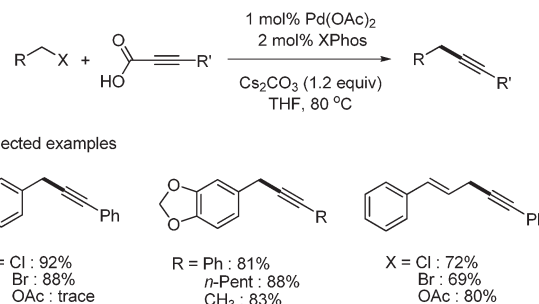

Scheme 7 Decarboxylative coupling with benzyl halides and acetates.

of benzyl chlorides, bromides, and acetate afforded the desired benzyl alkynes in good yields (Scheme 7). They first reported the decarboxylative coupling with aryl chlorides, although only three examples were shown. Chlorobenzene and 4-chloroacetophenone were coupled with phenylpropionic acid, giving the corresponding aryl alkynes in 76% and 75% yields, respectively. However, 4-chloroanisole produced the desired product in 19% yield (Scheme 8).

S. Lee developed a catalytic system of Pd(PPh₃)₂Cl₂ (5 mol%), dppb (10 mol%), DBU (2 equiv.), and DMSO for the synthesis of symmetric and unsymmetric diarylalkynes in decarboxylative coupling reactions.¹³ This system was an improved method meant to solve the previous problems associated with the necessity of excess of TBAF and air sensitive Pt-Bu₃. It was known that symmetric diarylalkynes were obtained in high yields when 1 equivalent of propionic acid and 2 equivalents of aryl bromides were reacted at 80 °C in this reaction system. Similar results were obtained when

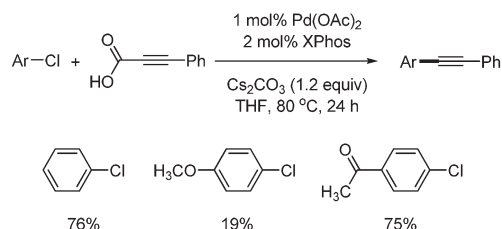

Scheme 8 Decarboxylative coupling with aryl chlorides.

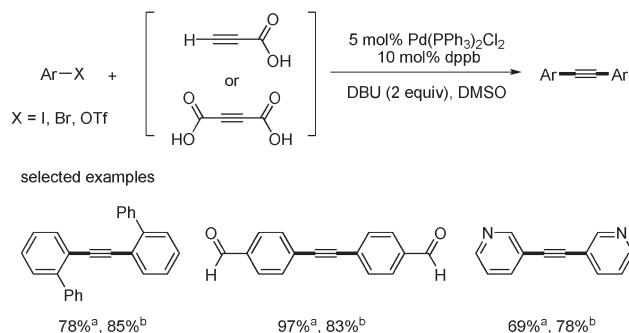

Scheme 9 Synthesis of symmetric diarylalkynes. ^aYield from propionic acid; ^byield from 2-butyndioic acid.

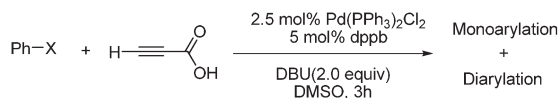

X	Temp (°C)	Ph-C≡C-CO ₂ H	Ph-C≡C-Ph
I	25	25%	-
I	50	84%	-
Br	50	-	-
Br	80	-	92%

Scheme 10 Coupling of propiolic acid with phenyl iodide and bromide.

2-butyndioic acid was reacted at 110 °C instead of propiolic acid (Scheme 9). Diarylated alkyne was found to form as a major product at 80 °C, even though 1 equivalent of phenyl bromide was reacted with 1 equivalent of propiolic acid. However, among the monoarylated products that were formed predominantly in the coupling reaction with aryl iodides at low temperatures, such as 25 and 50 °C, more Sonogashira coupling products (aryl alkynyl carboxylic acids) was formed than the decarboxylative coupling products (aryl acetylenes). However, phenyl bromide did not couple with propiolic acid at 50 °C (Scheme 10). When phenyl iodide and *p*-tolyl bromide were reacted with propiolic acid in the same reaction vessel under the optimized conditions, only phenyl iodide coupled product was formed as a major product (Scheme 11). Unsymmetric diarylalkynes were successfully synthesized by controlling temperature. All reagents, including aryl iodides, bromides, and propiolic acid, were added at the beginning of the reaction. When the reaction first proceeded at 50 °C for 5 h and then ran at 80 °C for 6 h, the desired unsymmetric diarylalkynes were obtained in good yields. However, the symmetrical diarylalkynes were formed as byproduct in 2–8% yields (Scheme 12).

To solve this problem, a continuous microflow reaction system was employed in the synthesis of unsymmetrical diarylalkynes (Scheme 13).¹⁴ The catalytic system is almost the same as that in the batch reaction. However, it is most important to find a system for all reagents to be in solution in order to apply the batch reaction methodology to flow chemistry. Because organic reactions that require insoluble reagents cannot be applied in flow chemistry. The optimized condition was first investigated under which all reagents exist

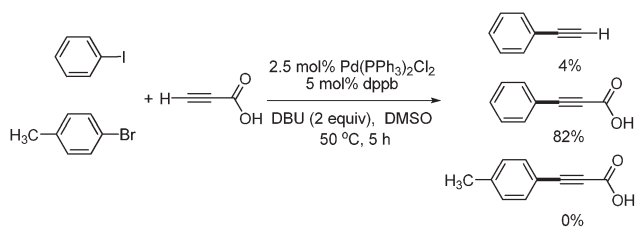

Scheme 11 Comparative experiment of aryl iodide and bromide in the coupling reaction.

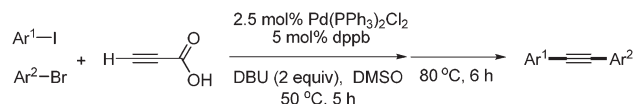

selected examples

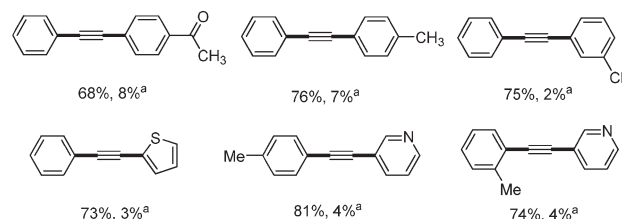

Scheme 12 Synthesis of unsymmetric diarylalkynes. ^aYield of symmetric diarylalkyne.

in solution at room temperature in the reservoir. The optimized condition found involved one reservoir containing aryl iodide and propiolic acid in DMSO, and another reservoir containing palladium, ligand, and DBU in DMSO. These two reservoirs were connected to a micromixer, and all reagents in two reservoirs were mixed and reacted in the microtube at 50 °C for 4 h. Then, the resulting mixture was mixed with aryl bromide in the second micromixer, and reacted in the microtube at 120 °C for 4 h. This continuous flow reaction system afforded unsymmetric diarylalkynes in high yields with a trace amount of symmetric diarylalkynes as byproducts, and

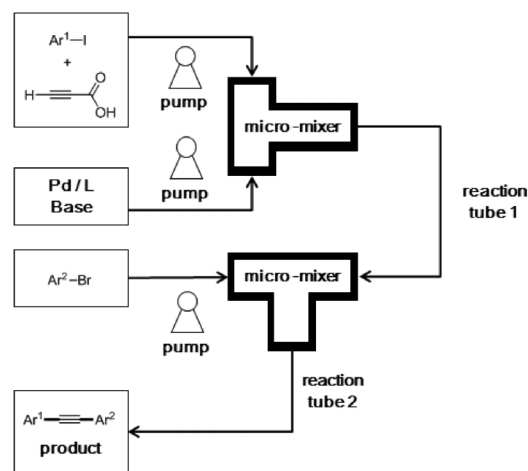

selected examples

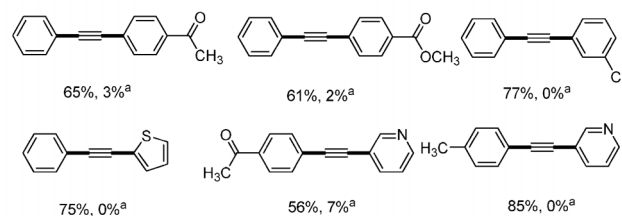

Scheme 13 Microflow reaction of decarboxylative coupling reaction, ^aYield of symmetric diarylalkynes.

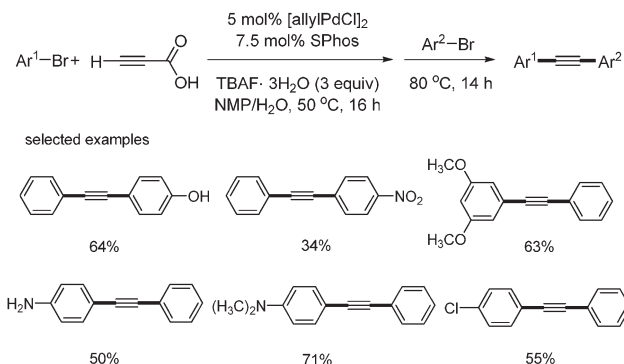

Scheme 14 Synthesis of unsymmetric diarylalkynes from two different aryl bromides.

showed high selectivity compared to the batch reaction system.

Two different aryl bromides were employed instead of aryl iodides and bromides for the synthesis of unsymmetric diarylalkynes from the decarboxylative coupling of propiolic acid.¹⁵ Goossen reported that [allylPdCl]₂ (2.5 mol%), SPhos (7.5 mol%), 3 equiv. of TBAF·3H₂O showed good yields in the synthesis of unsymmetric diarylalkynes. This selective reaction was also controlled by temperature. The first step consists of a Sonogashira coupling of the first aryl bromides with propiolic acid to afford aryl alkynyl carboxyl acid at 50 °C. The second step was run at 80 °C after the other aryl bromide was added. Good yields were shown in a wide range of unsymmetric diarylalkynes. Aryl bromides bearing hydroxyl and amine groups afforded the desired coupled product in good yields. However, there were no examples of one-pot reaction, in which all reagents are added at the beginning (Scheme 14).

S. Lee reported an aqueous system for the synthesis of symmetrical diarylalkynes from palladium-catalyzed decarboxylative coupling of propiolic acid and aryl bromides (Scheme 15).¹⁶ They were focused on propiolic acid as a

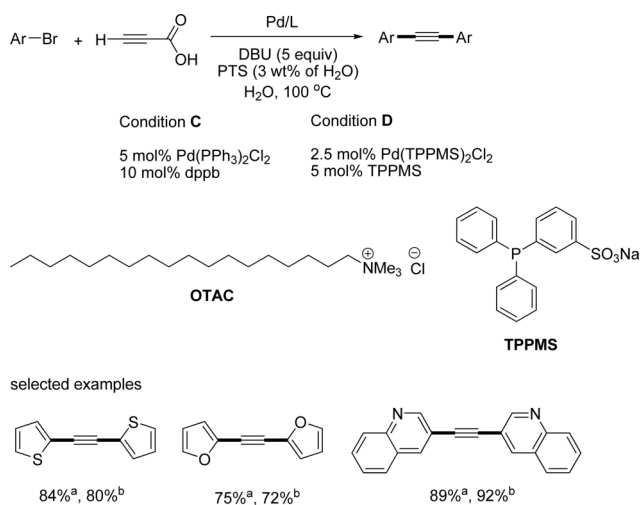

Scheme 15 Decarboxylative couplings in aqueous conditions; ^acondition C; ^bcondition D.

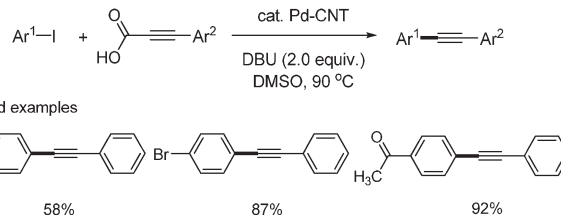

Scheme 16 Pd-CNT-catalyzed decarboxylative coupling.

suitable reagent for water-based solvent systems in the coupling reaction of alkyne due to its good solubility in water. Pd(TPPMS)₂Cl₂, a water-soluble palladium source, and TPPMS, a water-soluble ligand, showed good reactivity in the presence of octadecyl trimethyl ammonium chloride (OTAC) as a phase transfer surfactant (PTS). This method can be used under both microwave and thermal heating conditions. The microwave system produced the desired product in 15 min, and the thermal heating produced the product in 3–20 h. However, they did not succeed in the decarboxylative coupling with aryl iodides in the aqueous medium.

S. Lee and coworkers prepared Pd-CNT nanocomposite from a composite of thiolated MWCNT and Na₂PdCl₄.¹⁷ This palladium nanocomposite has an average diameter of 2.9 nm with a narrow size distribution for the Pd-CNT. This Pd-CNT was applied as a catalyst (5 mol% Pd) in the decarboxylative coupling of aryl alkynyl carboxylic acid and aryl iodides. Aryl iodides bearing cyano, bromo, and ketone groups produced the corresponding products in 58%, 87%, and 92%, respectively. This reaction system does not require an additional ligand, and showed good activities in a variety of aryl iodides as well as aryl alkynyl carboxylic acids (Scheme 16).

Very recently, Kantam reported a phosphine-free catalytic system for the decarboxylative coupling reaction of aryl halides.¹⁸ They synthesized a carboxyamido/carbene ligand and applied its palladium complex as shown in Scheme 17 in the decarboxylative coupling reaction of alkynyl carboxylic acid and aryl bromides. Only 0.5 mol% palladium catalyst was required for the synthesis of aryl alkynes. However, the

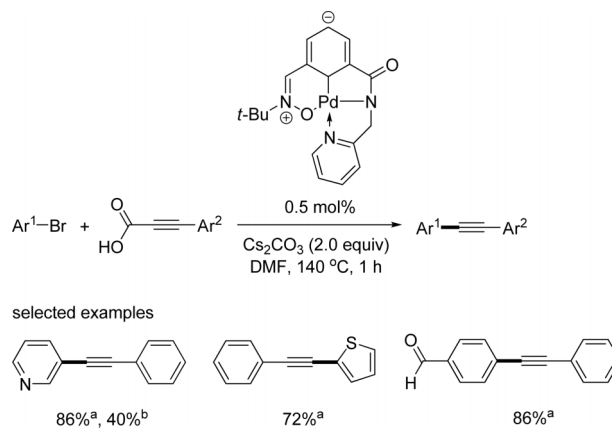

Scheme 17 Phosphine-free decarboxylative coupling reaction. ^aYield from ArBr; ^byield from ArCl.

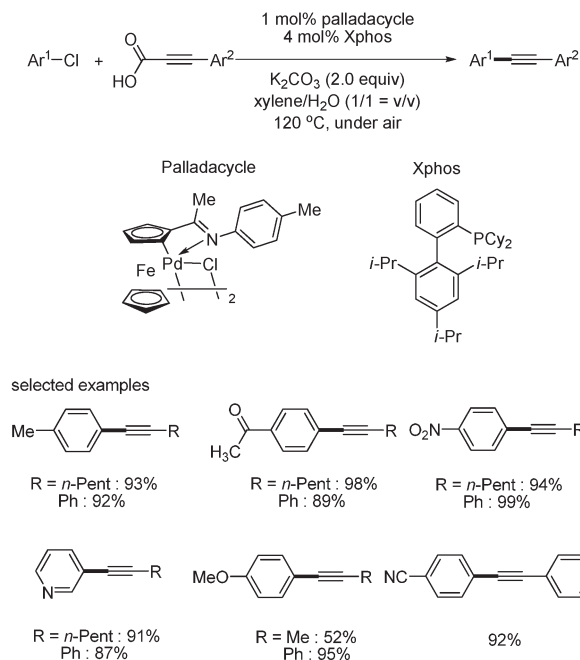

Scheme 18 Cyclopalladated ferrocenylimine-catalyzed decarboxylative couplings with aryl chlorides.

reaction temperature was high, and only two examples of aryl chlorides were reported.

Wu and coworkers reported decarboxylative coupling reaction of aryl chlorides by using cyclopalladated ferrocenylimine catalyst.¹⁹ The coupling of aryl chlorides with alkynyl carboxylic acids afforded the desired product in good yield as shown in Scheme 18. They showed that aryl chlorides bearing electron-poor, electron-neutral and even inactive sterically hindered electron-rich substituents afforded the desired decarboxylative coupled products in good yields.

To reveal the real ligand and the role of the air, Wu and coworkers conducted the controlling experiments as shown in Scheme 19. They found that phosphine ligand **L1** showed activity. However, phosphine oxide **L2**, which is easily formed from the oxidation of **L1**, did not give the coupled product. Based on these results, they suggested that the real ligand must be the alkyl phosphine ligand **L1**.

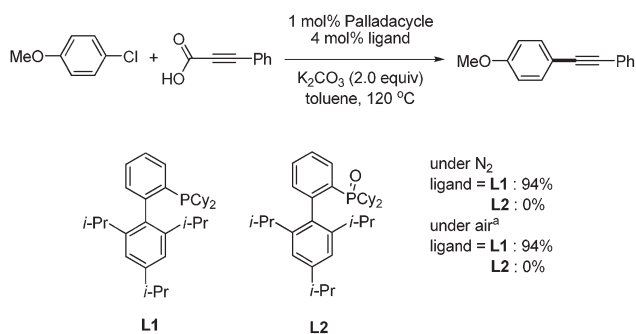

Scheme 19 Controlling experiments to define the real ligand under air, ^aToluene/H₂O (1/1) as solvent.

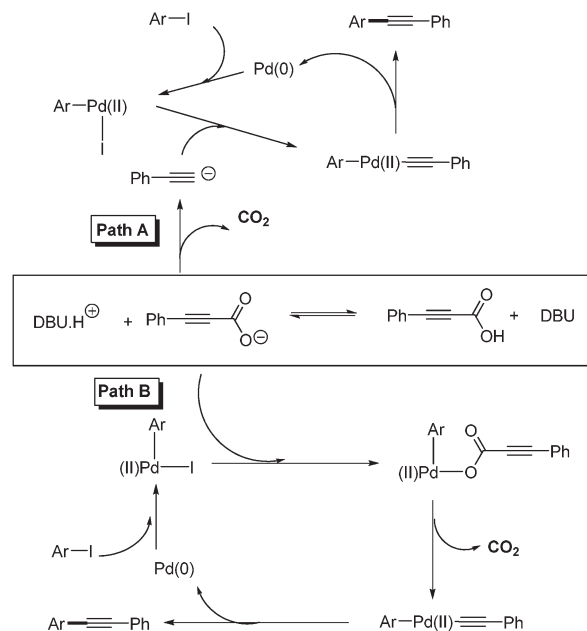

Scheme 20 Two proposed possible pathways in the decarboxylative coupling reaction.

S. Lee and coworkers also studied the mechanism of the decarboxylative coupling using gas chromatography and FT-IR spectroscopy.²⁰ They found that the decarboxylation of phenyl propionic acid occurred at 80 °C in the presence of DBU without any metal. Pathways **A** and **B** were suggested (Scheme 20). In path **A**, the decarboxylation step proceeds first, and then the decarboxylated alkyne reacts with aryl palladium(II) iodide complex. In path **B**, phenylpropionic acid reacts with aryl palladium(II) iodide complex to produce the phenylpropionate palladium complex before the decarboxylation step took place. They found that the yield of decarboxylative coupling is higher than that of the decarboxylation in 2 h at 80 °C. This result and the additional experimental data suggested that path **B** was suggested as the predominant pathway.

2.2. Coupling reactions with aryl boronic acids

Loh developed the decarboxylative coupling reaction with aryl boronic acid instead of aryl halides.²¹ They employed Pd(OAc)₂ (2 mol%) as a catalyst, Ag₂O as an oxidant, and KOAc as a base. The desired coupled product was obtained in good yields at room temperature. As shown in Scheme 21, heteroaromatic boronic acid provided good yield of the desired product. Aryl boronic acids possessing nitro group afforded the desired coupled product without the reduction of nitro group. With the 4-bromophenyl boronic acid, the aromatic halide survived in this coupling reaction. Alkyl alkynyl carboxylic acids showed good yields in this coupling reaction. The following mechanism was proposed: aryl palladium species was formed from the transmetalation of aryl boronic acid and palladium, and alkynyl silver complex was formed from the decarboxylation of aryl alkynyl carboxylic acid. The transmetalation between these two metal complexes produced palladium complex

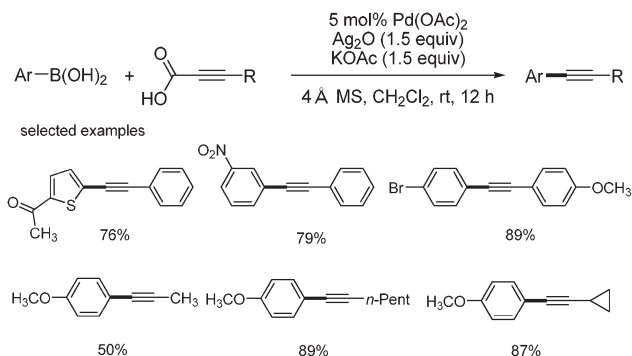

Scheme 21 Decarboxylative coupling with aryl boronic acids.

bearing two organic ligands, aryl and alkynyl group. Reductive elimination afforded the desired product and palladium(0) species, which is then oxidized by silver to regenerate the palladium(II). It was suggested that silver oxide works as an oxidant to oxidize the palladium(0), and as a decarboxylative agent to generate the desired alkynyl metal species (Scheme 22).

S. Lee and coworkers also reported decarboxylative coupling with aryl boronic acid using palladium hydroxysalen complex as a catalyst.²² The reaction showed good reactivity in the presence of 1 mol% of palladium hydroxyl salen complex at room temperature (Scheme 23). However, Loh and Lee had never reported that the decarboxylative coupling with propiolic acid and aryl boronic acid to give the corresponding aryl alkynes.

2.3. Decarboxylative coupling for the synthesis of diynes

Jiao and coworkers reported the synthesis of unsymmetrical diynes by the copper catalyzed decarboxylative *sp-sp* carbon bond formation of aryl alkynyl carboxylic acids and terminal alkynes.²³ The yields of the desired products was moderate under air, but it was trace under N₂. The optimized condition was that 10 mol% CuI and 10 mol% 1,10-phenanthroline was employed with Et₃N (2.0 equiv.). With the optimal condition, they showed the broad scope of the substrates (Scheme 24).

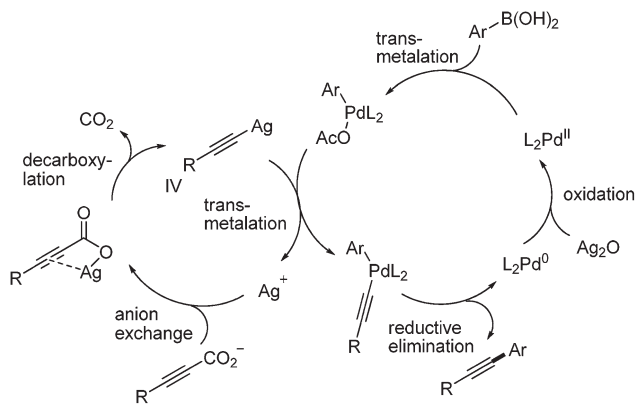

Scheme 22 Proposed mechanism of decarboxylative coupling with aryl boronic acids.

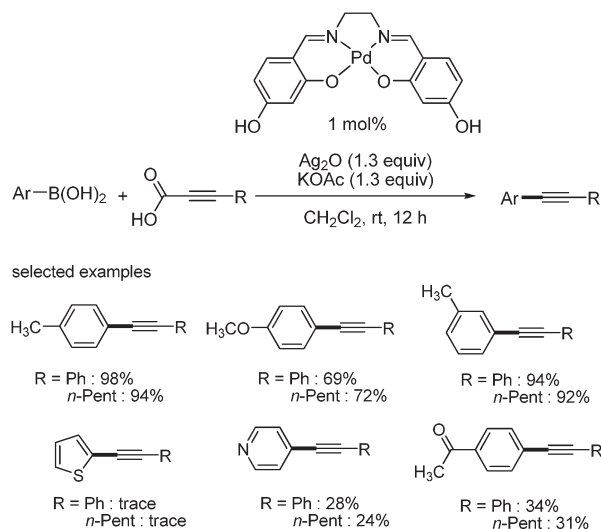

Scheme 23 Pd-hydroxysalen-catalyzed decarboxylative coupling with aryl boronic acids.

But 3-(furan-2-yl)propionic acid and alkyl substituted terminal alkynes showed lower yields than those from any others.

The direct synthesis of 1,4-diarylsubstituted 1,3-diynes from aryl iodides and propiolic acid was independently developed by S. Lee²⁴ and Kim.²⁵ They used Pd(PPh₃)₂Cl₂ and CuI as catalysts, but different bases and solvents were employed. S. Lee used DBU for the coupling reaction of propiolic acid and aryl iodides, and used K₂CO₃ for the homocoupling of aryl alkynyl carboxylic acid in DMSO solvent (Scheme 25). Kim used Et₃N and Ag₂CO₃ in DMF (Scheme 26). The major difference is that S. Lee conducted a one-pot reaction by controlling temperature, whereas Kim performed two-step reactions by the sequential addition of reagent. However, the formation of diarylalkynes as a byproduct was inevitable in both cases.

Fu reported the copper-catalyzed decarboxylative coupling reaction of potassium alkynyl carboxylates with 1,1-dibromo-1-

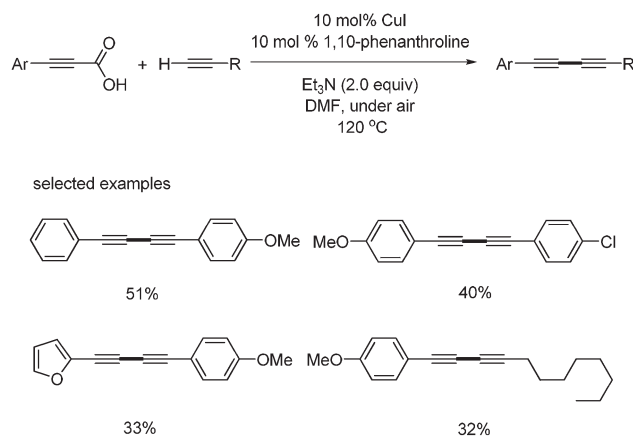

Scheme 24 Copper-catalyzed decarboxylative coupling with aryl propiolic acid with terminal alkynes.

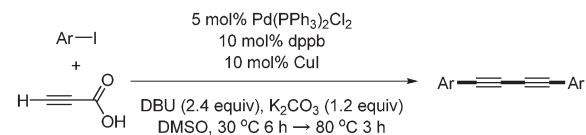

selected examples

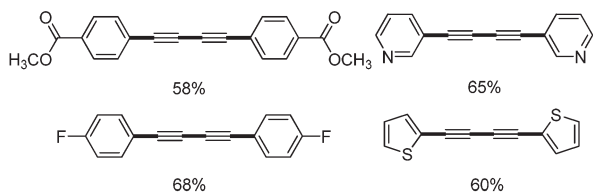
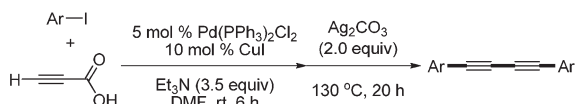
**Scheme 25** Synthesis of diynes in the presence of K_2CO_3 .

selected examples

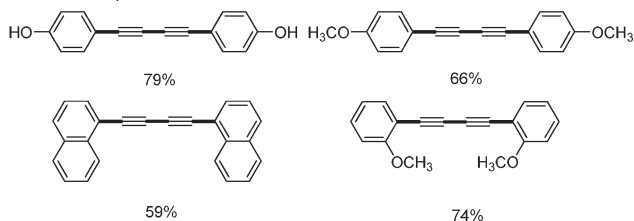
**Scheme 26** Synthesis of diynes in the presence of Ag_2CO_3 .

alkenes for the synthesis of unsymmetrical diynes.²⁶ They found that neocuproine was the best ligand than any others phosphine and amine based ligands (Scheme 27).

2.4. Decarboxylative coupling with C–H activation

Zhao reported the synthesis of C-3 alkylnylated indolizines *via* the C–H activation of indolizine and decarboxylation of alkylnyl carboxylic acid.²⁷ The palladium-catalyzed direct arylation of heteroaromatic compounds such as indolizines with aryl halides has been studied. This C–H activation toward decarboxylative coupling reaction was expanded. Substituted indolizines provided C–H activated coupled products in good yields in the presence of $Pd(OAc)_2$ (5 mol%) and Ag_2CO_3 (1.0 equiv.) (Scheme 28). The proposed mechanism was as follows: the palladium(II) was reacted with alkylnylsilver, which was formed from decarboxylation of phenyl propiolic acid, affording alkylnyl palladium complex, followed by electrophilic attack of the generated Pd(II) species to indolizine group to produce alkylnyl indolizinyll palladium complex. Reductive elimination of palladium complex releases coupled product and Pd(0) species, which are regenerated and oxidized to Pd(II) by silver (Scheme 29).

2.5. Decarboxylative carbonylations

Sonogashira-type decarboxylative carbonylation was first reported by S. Lee.²⁸ Alkylnyl carboxylic acid was decarboxylated in a carbon monoxide atmosphere, affording carbonyla-

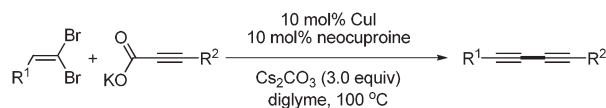

selected examples

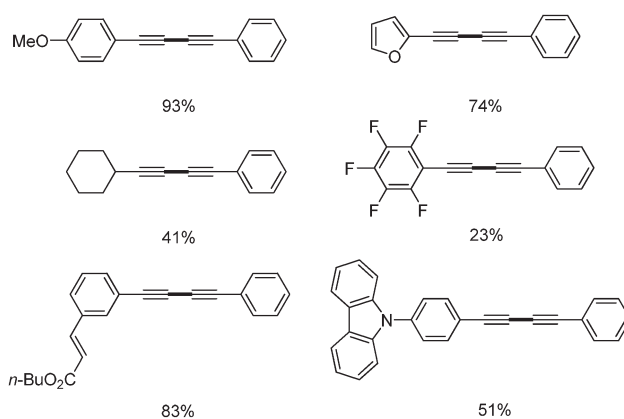
**Scheme 27** Synthesis of diynes from 1,1-dibromo-1-alkenes and alkylnyl carboxylic acids.

tive coupled product. 0.5 mol% $Pd(PPh_3)_2Cl_2$ was employed without any additional ligand. When Et_3N was used as a base instead of DBU, the product yields showed good. Under these optimized conditions, a variety of aryl iodides produced the desired α,β -alkynyl aryl ketones in good yields (Scheme 30).

Non-carbonylative coupling product was formed as a byproduct in the presence of CuI. However, in the absence of CuI, the desired carbonylative coupling product was formed without any formation of non-carbonylative coupling product (Scheme 31).

As an expansion of decarboxylative carbonylation, S. Lee reported the synthesis of aryl alkynes from the palladium-catalyzed selective carbonylative and non-carbonylative coupling reaction of propiolic acid.²⁹ When aryl iodide (2 equiv.) and propiolic acid (1 equiv.) were reacted under CO (8 atm) with $Pd(PPh_3)_2Cl_2$ (5 mol%), CuI (10 mol%), and Et_3N (6

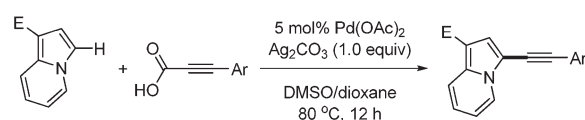

selected examples

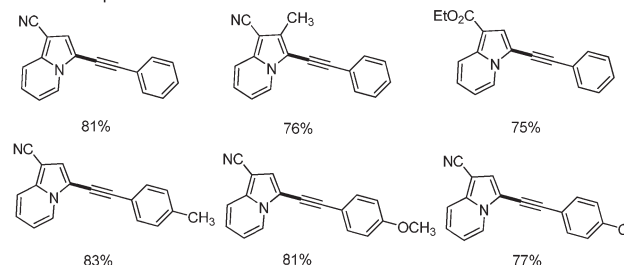
**Scheme 28** C–H activation with decarboxylative coupling.

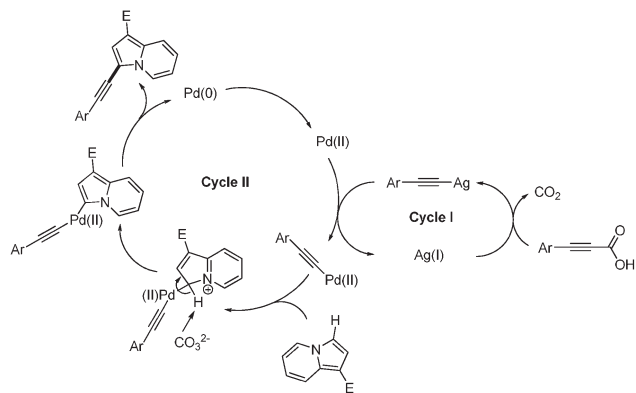

Scheme 29 Proposed mechanism of C–H activation with decarboxylative coupling.

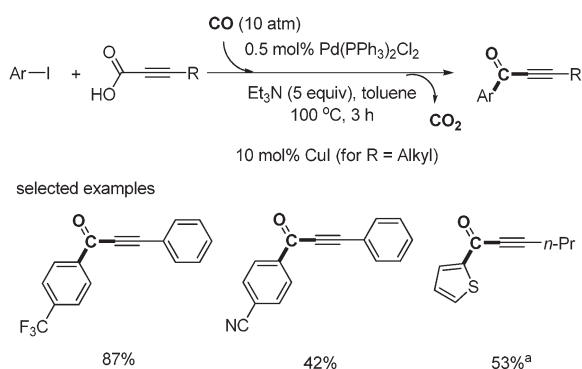

Scheme 30 Decarboxylative carbonylation, ^a10 mol% of CuI were used.

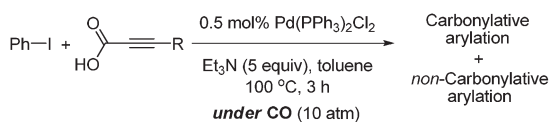

R	CuI	Ph-C(=O)-C≡C-R	Ph-C≡C-R
Ph	-	89%	0%
Ph	10 mol%	59%	44%
<i>n</i> -Pent	-	38%	0%
<i>n</i> -Pent	10 mol%	71%	13%

Scheme 31 Copper effect in the decarboxylative carbonylation.

equiv.), aryl iodide proceeded in selectively non-carbonylative and carbonylative coupling toward propiolic acid (Scheme 32). They found that alkyne carboxylic acid prefers carbonylative coupling in both the presence and absence of CuI. However, terminal alkyne afforded carbonylative product in the presence of CuCl and non-carbonylative product in the absence of CuCl.

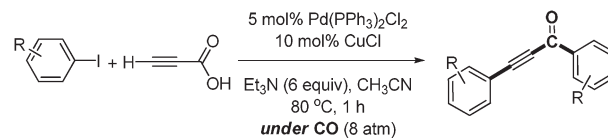

selected examples

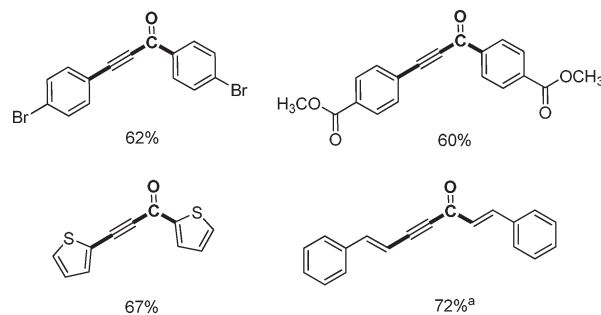

Scheme 32 One-pot synthesis of diaryl alkynes. ^a β -Bromostyrene was used.

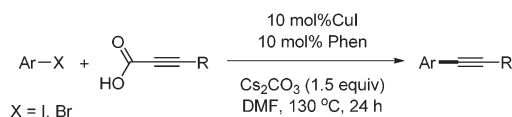

selected examples

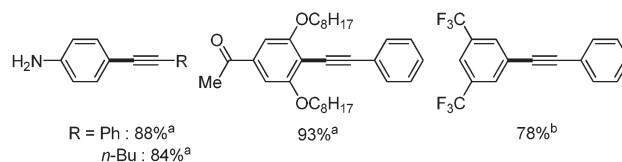

Scheme 33 Decarboxylative coupling by copper catalyst. ^aYield from aryl iodide; ^byield from aryl bromide.

3. Copper-catalyzed decarboxylative couplings

Xue and coworkers first reported the copper-catalyzed decarboxylative coupling of aryl alkynyl carboxylic acid with aryl iodides and bromides.³⁰ The catalytic system of CuI (10 mol%) and phenanthroline (10 mol%) afforded the desired product in good yields in the presence of Cs₂CO₃. Although the reaction temperature was high (130 °C), this reaction method showed good tolerance toward functional groups such as alcohols, amines, ketones, esters, nitros, and carboxylic acids (Scheme 33). In addition, they provided the one-pot synthesis of benzofuran from the domino reaction of 2-iodophenyl and alkynyl carboxylic acid (Scheme 34). Based on computational investigation, they suggested that the oxidative addition of aryl iodides to copper(I) first occurred and produced copper(III) complex, which subsequently reacted with alkynyl carboxylic acid to give the desired coupled product through decarboxylation and reductive elimination (Scheme 35).

Mao reported an improved method (lower catalyst loading) for copper-catalyzed decarboxylative coupling reactions (Scheme 36).³¹ They used Fe(acac)₃ as a co-catalyst and reduced the amount of copper catalyst to 0.5 mol%. 2 : 1 or

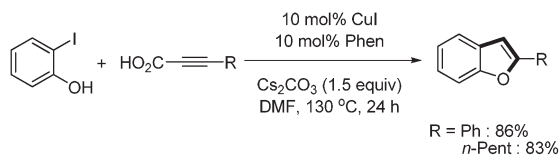

Scheme 34 Synthesis of benzofuran from the domino reaction.

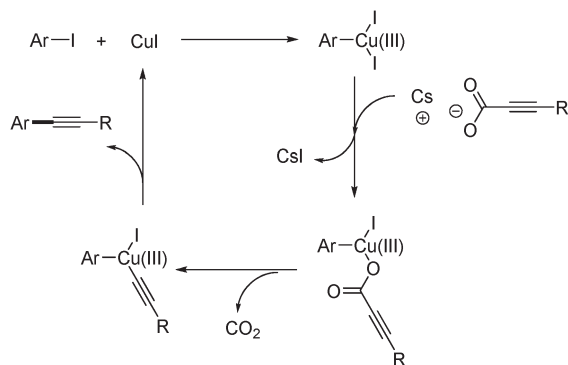

Scheme 35 Proposed mechanism of the copper-catalyzed decarboxylative coupling reaction.

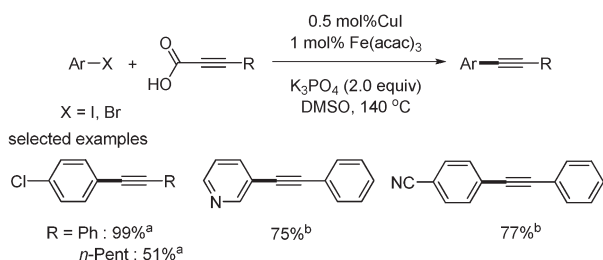

Scheme 36 Copper-iron-catalyzed decarboxylative coupling. ^aAryl iodide was used; ^baryl bromide was used.

1 : 2 Fe catalyst to Cu catalyst ratios had better results than the 1 : 1 ratio. The reaction was carried out with K₃PO₄ at 140 °C under argon. In their reaction system, the addition of palladium catalyst did not improve the yield of product (Scheme 37). Based on this result, contamination by residual transition metals in the catalytic system of Cu/Fe was ruled out.

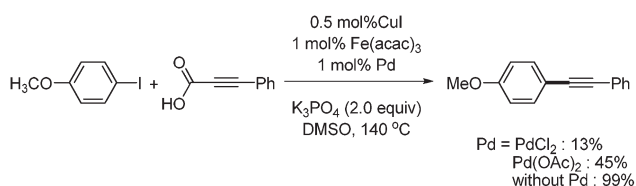

Scheme 37 Palladium effects of copper-iron-catalyzed decarboxylative coupling.

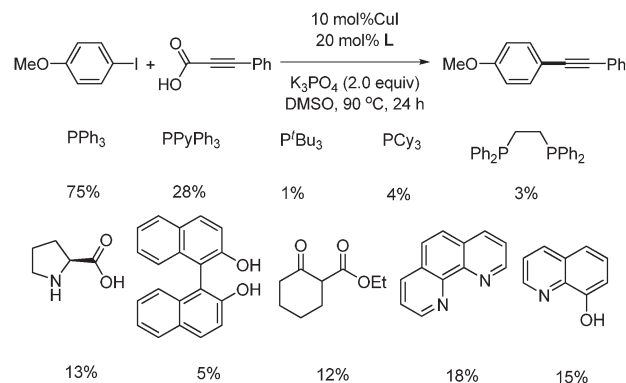

Scheme 38 Screening of ligands in the copper-catalyzed decarboxylative coupling reaction.

Two years later, a catalytic system of CuI/PPh₃ without iron in the decarboxylative coupling of alkynyl carboxylic acids with aryl iodides and bromides was reported.³² Compared with the previous report, the amount of copper catalyst was increased to 2 mol%, and the reaction temperature was decreased to 90 °C. However, the reaction was still conducted under argon. Among the phosphines and amines ligands tested, PPh₃ showed the best yield (Scheme 38). This catalytic system was employed for decarboxylative coupling in water.³³ The reaction conditions were almost the same as those in the previous reported system. Aryl iodides were reacted in the presence of CuI (2 mol%), PPh₃ (4 mol%), and K₂CO₃ (3 equiv.), affording the desired product in good yields (Scheme 39). In the case of aryl bromides, TBAB (tetrabutyl ammonium bromide) as the phase transfer catalyst and 2 equiv. of NaI were required for higher yields. The suggested mechanism was that copper(I) first reacts with alkynyl carboxylic acid and produces the alkynyl copper complex through decarboxylation. The alkynyl copper complex reacts with aryl halides and forms aryl alkynyl copper complex, which produces the desired product after reductive elimination. (Scheme 40). Their suggested mechanism was opposite to the previous report by Xue and coworker, in which the oxidative addition of aryl halide occurred on Cu(I) before decarboxylation.

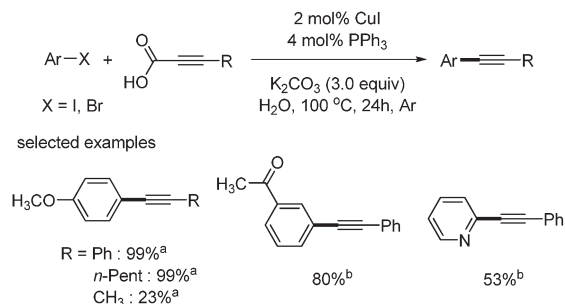

Scheme 39 Cu/PPh₃-catalyzed decarboxylative coupling reactions in water. ^aAryl iodide was used; ^baryl bromide, 2 equiv. of NaI and 1 equiv. of TBAB were used.

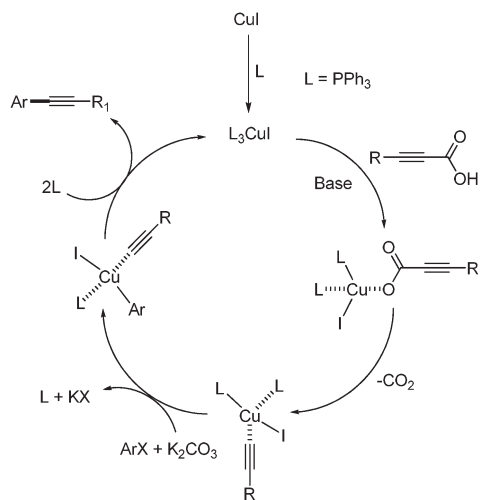

Scheme 40 Proposed mechanism of the copper-catalyzed decarboxylative coupling reaction in aqueous condition.

Muthusubramanian reported the copper-catalyzed synthesis of 2-arylindoles from domino decarboxylative coupling and cyclization.³⁴ They prepared aryl alkynyl carboxylic acids from the coupling reaction of aryl iodides and propiolic acid in the presence of Pd(PPh₃)₂Cl₂ (2 mol%), CuI (4 mol%), and iPr₂NH (2.5 equiv.). When 2-iodotrifluoroacetanilide and aryl alkynyl carboxylic acids were reacted with CuBr (5 mol%), L-proline (15 mol%), and K₂CO₃ (2 equiv.), the desired 2-arylindole was formed in good yields (Scheme 41). When 2-iodobenzoic acid and phenyl propiolic acid were reacted under the same conditions in DMF, a mixture of isocoumarin and phthalide was formed in equal amounts with an overall yield of 52% (Scheme 42).

Jiao and coworkers reported the coupling reaction of aryl boronic acids instead of aryl halides by the copper catalyst.³⁵ When benzoquinone, Et₃N and pyridine (2 equivalents) and under an air atmosphere with CuCl₂·2H₂O showed good catalytic activity for the coupling reaction. However, the usage of the electron deficient aryl boronic acids or alkyl alkyne carboxylic acid for the reaction resulted in the low yields of the coupled products (Scheme 43).

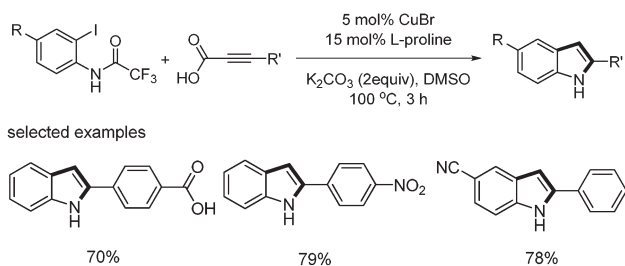

Scheme 41 Synthesis of 2-arylindoles.

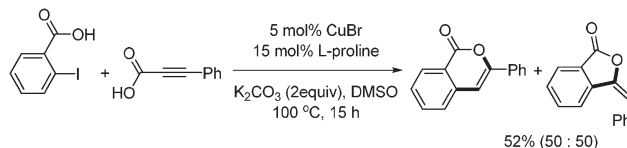

Scheme 42 Synthesis of isocoumarin and phthalide.

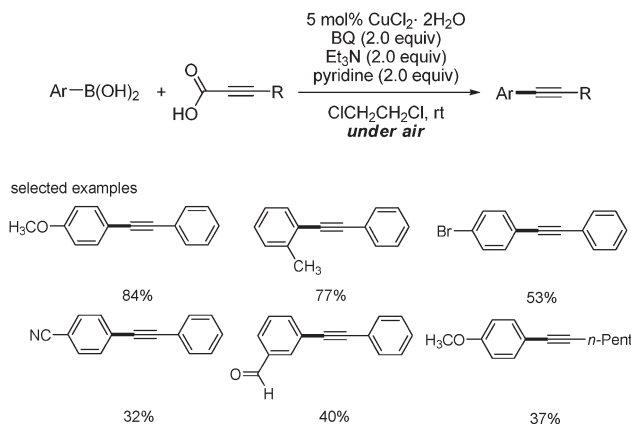

Scheme 43 Copper-catalyzed decarboxylative coupling of aryl boronic acids.

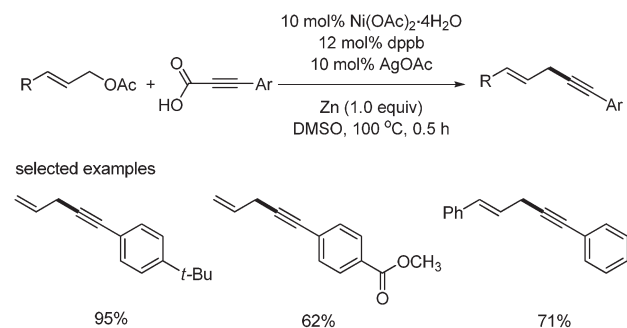

Scheme 44 Nickel-catalyzed decarboxylative coupling.

4. Nickel-catalyzed coupling reaction

Nickel-catalyzed decarboxylative coupling reaction of alkynyl carboxylic acids were first reported by S. Lee³⁶ Allyl acetate was employed as a coupling partner. Ni(OAc)₂·4H₂O (10 mol%) and dppb (12 mol%) were used as a catalyst and ligand, respectively (Scheme 44). 10 mol% AgOAc and 1 equivalent of Zn were respectively employed as an additive and reducing agent of Ni(II). The reactions were carried out at 100 °C for 0.5 h. A variety of the substituted aryl alkynyl carboxylic acid was coupled with allyl acetate, affording the desired products in good yields. Interestingly, the allenes were obtained in the presence of bases such as Cs₂CO₃ and DBU (Scheme 45).

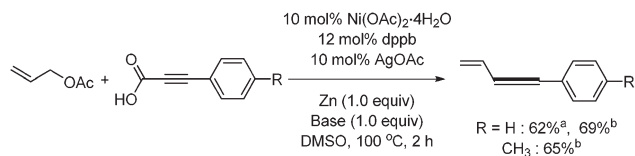

Scheme 45 Synthesis of allenes, ^aCs₂CO₃ was used, ^bDBU was used.

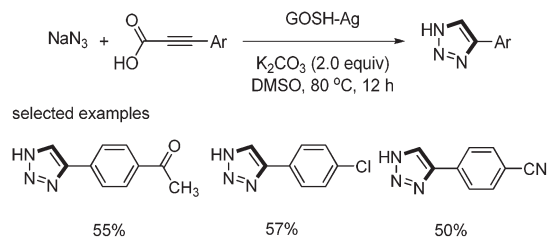

Scheme 46 Silver-catalyzed decarboxylative cyclization reactions leading to triazoles.

5. Silver catalyzed-coupling reaction

The decarboxylative addition of aryl propiolic acid and NaN₃ was reported by Choi and S. Lee³⁷ Silver-decorated graphene oxide catalyst (GOSH-Ag) was prepared by depositing silver nanoparticles on thiolated graphene oxide (GOSH) surfaces. When 1 mol% of GOSH-Ag was used in the reaction of phenyl propiolic acid and NaN₃, the desired 1,2,3-triazole was formed in good yields (Scheme 46). This catalyst could easily be separated and recovered from the reaction mixture and reused several times.

6. Synthesis of aryl alkynyl carboxylic acids

With increasing attention being paid to the decarboxylative coupling of alkynyl carboxylic acid, a variety of synthetic methods have been developed for their synthesis. There are a number of methods to synthesize alkynyl carboxylic acids, including the hydrolysis of alkynyl carboxylates,^{38a} the elimination of bromo-substituted carboxylic acids,^{38b} the oxidation of alkynyl alcohols and aldehydes,^{38c} and the carboxylation of alkynes.^{38d,38e} Among these, C-H carboxylation of terminal alkynes with carbon dioxide has been studied more often and more widely used. However, this approach has several drawbacks, such as the preparation of the terminal alkyne as a starting material from the Sonogashira coupling, and the employment of carbon dioxide, which necessitates special equipment. To overcome these problems, the direct synthesis of aryl alkynyl carboxylic acid from the site-selective Sonogashira coupling reaction of propiolic acid and aryl halides has been developed.

The Sonogashira coupling reaction of propiolic acid and aryl bromides was first reported by Buchwald³⁹ The reaction was carried out with Pd(CH₃CN)₂Cl₂ and sulfonated XPhos, a water-soluble phosphine ligand (Scheme 47). The reaction was

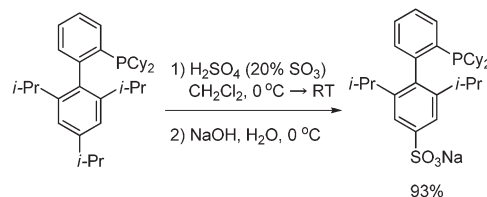

Scheme 47 Preparation of sulfonated XPhos.

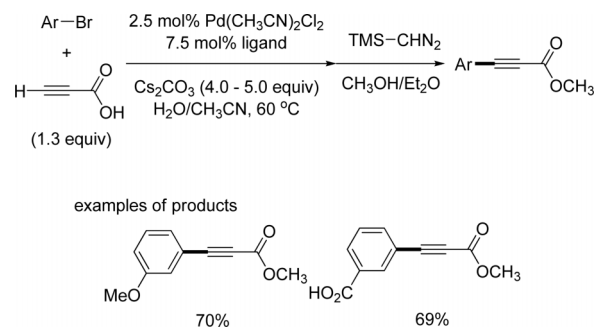

Scheme 48 Coupling reaction of propiolic acid and aryl bromides.

conducted in a mixture solvent of water and CH₃CN. However, the desired product aryl alkynyl carboxylic acid was converted to methyl ester using trimethylsilyldiazomethane to ease purification. For this reaction to proceed the reaction temperature was set at 60 °C, and the ligand has to be prepared (Scheme 48).

S. Lee developed the direct synthesis of aryl alkynyl carboxylic acid from the site-selective reaction of propiolic acid with aryl iodides.⁴⁰ The reaction was carried out with Pd(PPh₃)₂Cl₂ (2.5 mol%), dppb (5 mol%), and DBU (2 equiv.) at

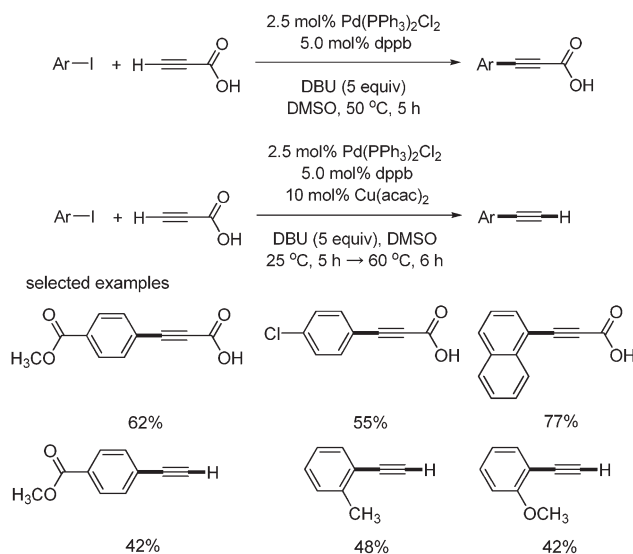

Scheme 49 Synthesis of aryl alkynyl carboxylic acids and aryl alkynes.

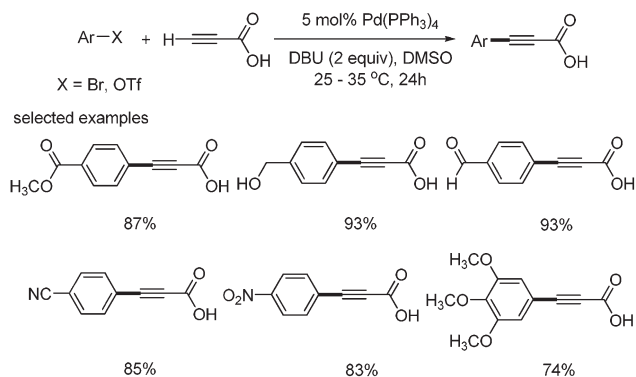

Scheme 50 Synthesis of aryl alkynyl carboxylic acids from aryl bromides.

50 °C. When Cu(acac)₂ was added to the reaction mixture, the desired aryl alkynyl carboxylic acid was formed at 25 °C, and the resulting mixture afforded decarboxylated product, aryl acetylene, at 60 °C. This reaction method provided a simple and efficient tool for the synthesis of aryl alkyne carboxylic acid and aryl acetylene from aryl iodides. Under these reaction conditions, only aryl iodides coupled with propiolic acid, and produced the corresponding aryl alkynyl carboxylic acid and terminal alkynes (Scheme 49).

S. Lee and coworkers reported the synthesis of aryl alkynyl carboxylic acid from the Sonogashira coupling of propiolic acid and aryl bromides or aryl triflates using Pd(PPh₃)₄.⁴¹ The reaction temperature was 25 °C for aryl bromides bearing electron withdrawing groups, and 35 °C for those bearing electron donating groups. Their method showed good tolerance toward functional groups such as alkoxy, ketone, ester, aldehydes, cyano, nitro, and hydroxyl (Scheme 50). In addition, they found that propiolic acid showed higher reactivity than other terminal alkynes. Among terminal alkynes, only propiolic acid coupled with 4-*tert*-butylbromobenzene to produce the desired product in 83% yield (Scheme 51). They found that the oxidative adduct palladium complex reacted with propiolic acid to produce the coupled product, even in the presence of phenyl acetylene (Scheme 52). Based on mechanistic studies using chronoamperometric analysis,⁴¹ it was suggested that the key reaction step for the high reactivity of propiolic acid might be ligand exchange between the acetylide and bromide at palladium, and/or reductive elimination, but not the oxidative addition step.

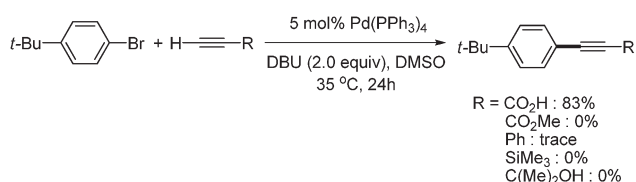

Scheme 51 Sonogashira reaction with terminal alkynes.

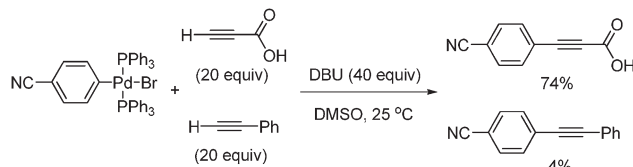

Scheme 52 Comparative coupling reaction of phenyl acetylene and propiolic acid.

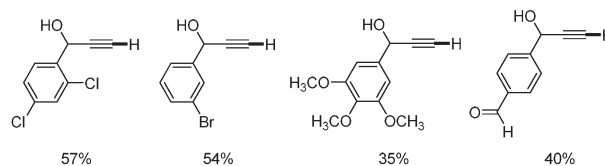
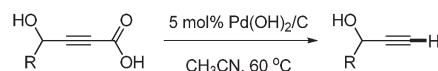

Scheme 53 Decarboxylation using Pd(OH)₂/C.

7. Decarboxylation

Kolarovic first reported the copper-catalyzed decarboxylation of alkynyl carboxylic acids.⁴² The catalytic systems of Pd(OH)₂/C did not give satisfactory results in the decarboxylations (Scheme 53). The best result was obtained when CuCl (5 mol%) was employed in CH₃CN at 60 °C. It was found that the presence of 3 equivalents of Et₃N accelerated the reaction rate in some cases (Scheme 54).

8. Coupling reactions for the formation of C–N[−]1–P/C–S bonds

Decarboxylative carbon–nitrogen bond formation was reported by Jiao⁴³ The coupling reaction of alkynyl carboxylic acids and amides afforded the desired ynamides *via* copper-catalyzed

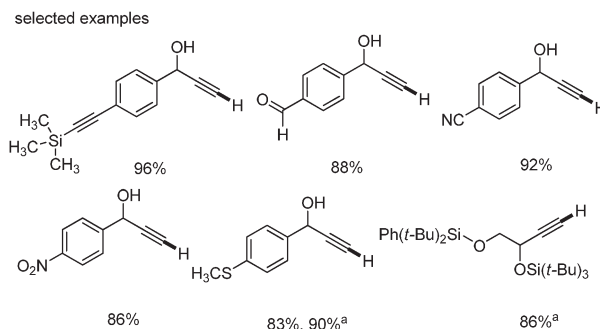
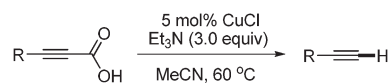

Scheme 54 Copper-catalyzed decarboxylation. ^aEt₃N 3.0 equiv. was used.

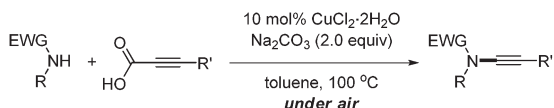

selected examples

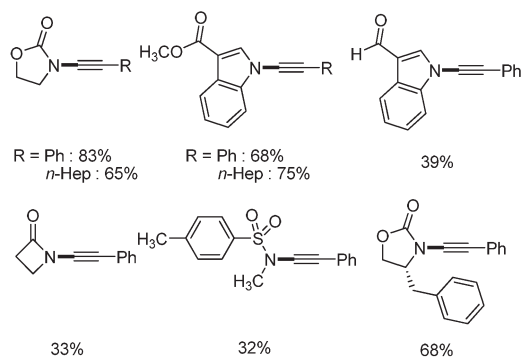
**Scheme 55** Decarboxylative C–N bond formation.

oxidative amidation. The optimized conditions involved $\text{CuCl}_2 \cdot 2\text{H}_2\text{O}$ (10 mol%) as a catalyst and Na_2CO_3 as a base. In addition, air was needed as an oxidant to complete the catalytic cycle. A variety of substituted aryl alkynyl carboxylic acids showed good yields, but only secondary amines bearing electron withdrawing groups such as carbonyl and sulfonyl produced the desired C–N bonded products. Tolerance toward functional groups such as ester, aldehyde, and sulfone was demonstrated (Scheme 55). The mechanism shown in Scheme 56 was suggested showing that alkynyl copper(II) was formed *via* the decarboxylation of copper(II) intermediate. Nucleophilic attack by the amide compound affords the $\text{Cu(II)}(\text{alkynyl})(\text{amidate})$ intermediate, followed by reductive elimination leading to the desired product. Cu(0) was reoxidized by air to fulfill the catalytic cycle (Scheme 56).

Yang and coworkers have developed the C–P bond formation of aryl alkynyl carboxylic acids with HP(O)R_2 through the catalytic combined efforts of both palladium and copper (Scheme 57).⁴⁴ The usage of 1,10-phenanthroline and PPh_3 as ligands, and AgOAc as oxidant in NMP provided good yields of the coupling reaction products.

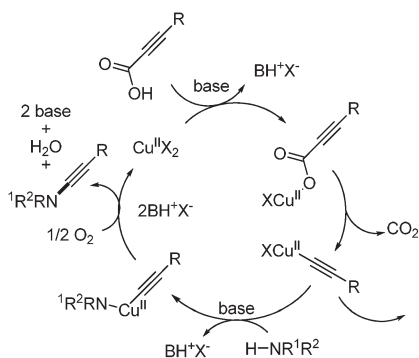
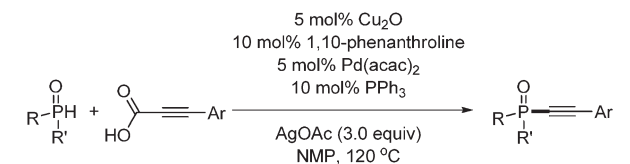
**Scheme 56** Proposed mechanism of decarboxylative C–N bond formation.

selected examples

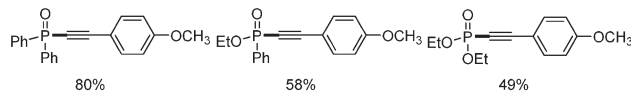
**Scheme 57** Decarboxylative C–P bond formation.

Liu reported copper-catalyzed decarboxylative C–S cross-coupling.⁴⁵ When alkynyl carboxylic acid and thiol were reacted in the presence of CuI (4 mol%) and Cs_2CO_3 (1.2 equiv.), vinyl sulfides were formed, not the alkynyl sulfides. All thiols afforded anti-Markovnikov coupling products in good to excellent yields with high stereoselectivity for *Z*-isomers. Importantly, this method was tolerant of a broad range of functional groups, including amines, alcohols, halides, and nitrogen-containing heterocycles. The tolerance of halides enables further derivatization through cross-coupling reactions (Scheme 58).

9. Multicomponent coupling reactions

Van der Eycken and coworkers reported the synthesis of 1,4-diamino-2-butyne using copper-catalyzed one-pot coupling reaction of propiolic acid, aldehyde, and amine.⁴⁶ Symmetrical substituted diamino alkynes were obtained when the reaction was conducted under microwave conditions. Alkyl aldehydes showed good yields, but benzaldehyde gave only 28% yield. Only secondary amines afforded the desired product. The primary amine produced only trace amounts of the desired product (Scheme 59).

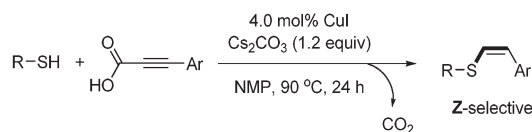

selected examples

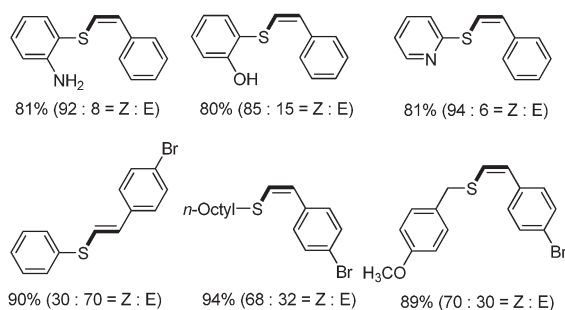
**Scheme 58** Decarboxylative C–S bond formation.

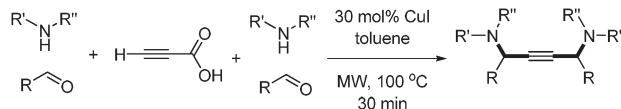

selected examples

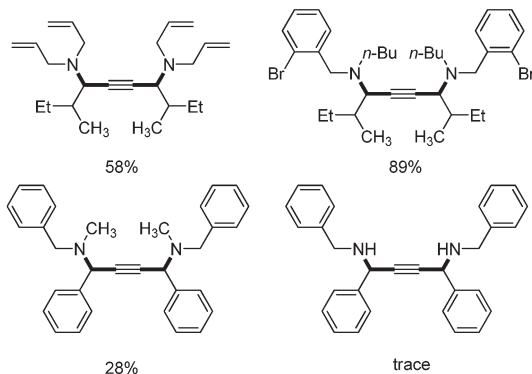

Scheme 59 Synthesis of 1,4-diamino-2-butyne from three-component reaction.

Three-component click-chemistry coupling reaction was reported by Kolarovic.⁴⁷ Aryl iodides, NaN_3 , and alkynyl carboxylic acid were reacted in the presence of $\text{CuSO}_4 \cdot 5\text{H}_2\text{O}$ (10 mol%), sodium ascorbate (20 mol%), L-proline (20 mol%), and K_2CO_3 (1.2 equiv.) to afford the desired 1,2,3-triazoles in good yields. This method avoids the usage of volatile low-molecular-weight terminal alkynes, reduces the handling of potentially unstable and explosive azides, and provides the desired product with good purity without any additional purification steps. In addition, alternative reaction conditions were provided to allow for both non-decarboxylative and decarboxylative coupling product (Scheme 60). Similar decarboxylative click-chemistry reaction was reported by Schoffstall⁴⁸ They employed alpha-bromoacetophenone instead of aryl halides (Scheme 61).

S. Lee reported the copper-catalyzed one-pot synthesis of imidazo[1,2-a]pyridines from the three-component reaction of 2-aminopyridine, aldehyde, and alkynyl carboxylic acids.⁴⁹ The catalysts of CuI and $\text{Cu}(\text{OTf})_2$ afforded the desired imidazo[1,2-

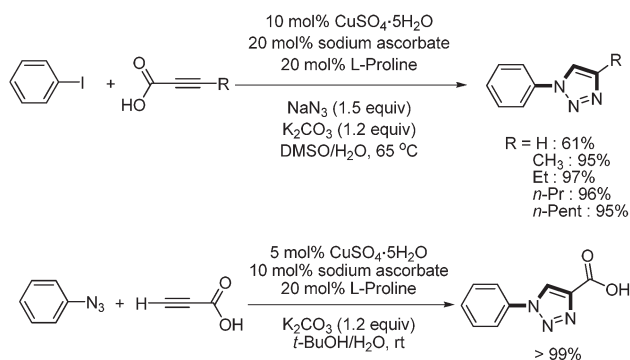

Scheme 60 Synthesis of 1,2,3-triazole from alkynyl carboxylic acid.

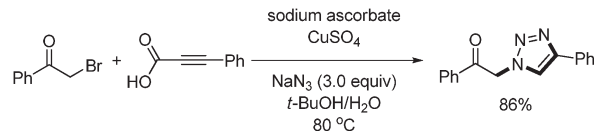

Scheme 61 Three-component reaction for the synthesis of 1,2,3-triazole.

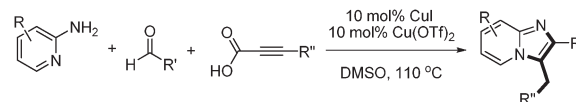

selected examples

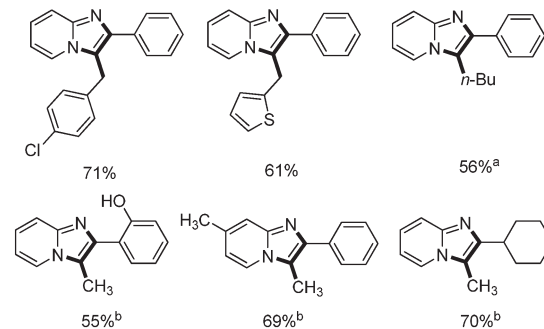

Scheme 62 Three-component reaction for the synthesis of imidazo[1,2-a]pyridines. ^a2-Pentynoic acid was used; ^bpropionic acid was used.

a]pyridines in good yields. Good yields were obtained with propionic acid (Scheme 62). Aryl alkynyl carboxylic acids were prepared *in situ*, and used for the coupling reaction with 2-aminopyridine and benzaldehyde. Based on this concept, S. Lee also reported the four-component reactions of 2-aminopyridine, aldehyde, aryl iodide and propionic acid to produce the desired imidazo[1,2-a]pyridine in good yields. (Scheme 63).

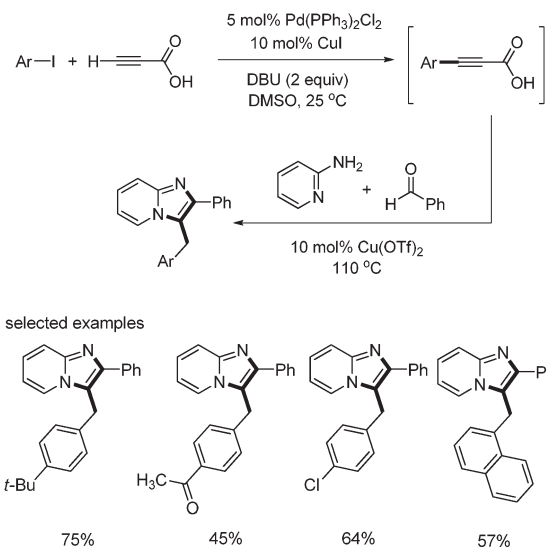

selected examples

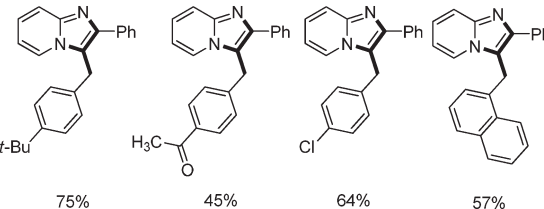

Scheme 63 Four-component reaction for the synthesis of imidazo[1,2-a]pyridines.

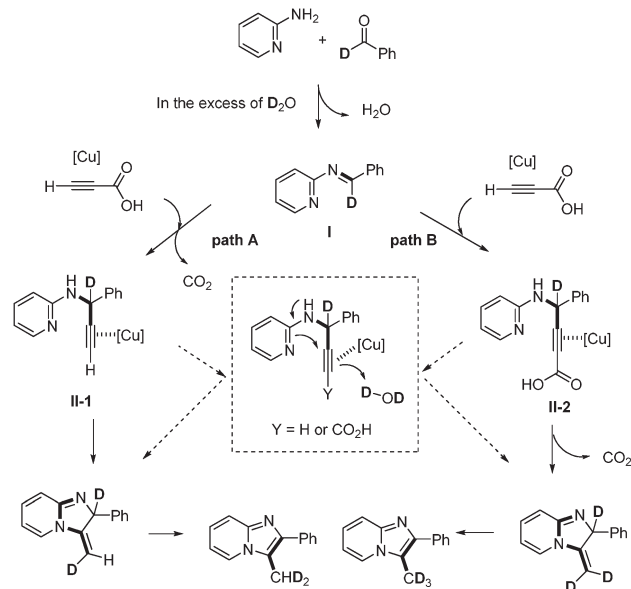

Scheme 64 Proposed mechanism of the decarboxylative coupling reaction in the synthesis of imidazo[1,2-a]pyridines.

In the reaction with propiolic acid, two pathways were proposed to form 3-methyl-2-phenylimidazo[1,2-a]pyridine: path A, in which the decarboxylative coupling reaction occurs first, and path B, in which the reaction at the terminal alkynyl carbon occurs first. Deuterium exchange experiments showed that dideuterated product was formed much more than trideuterated product. This result suggested that two alternative pathways, C and D, are both involved in the reaction, but that path C dominates over path D (Scheme 64).

10. Applications

T. C. Lin and coworkers synthesized a series of star-shaped multipolar chromophores containing functionalized quinoxaline and quinoxalinoid units that showed two-photon absorption properties, both in the femtosecond and the nanosecond time domain.⁵⁰ For the synthesis of diaryl alkyne precursor, 2-butyne-1,3-diol was employed as an alkyne source, which was developed by S. Lee, instead of using their previous methodology.¹³ The desired diaryl alkyne was successfully obtained in 85% yield from the coupling reaction of aryl bromides and 2-butyne-1,3-diol (Scheme 65).

Loye synthesized unsymmetrically substituted heterocyclic alkyne 5-(pyridin-3-ylethynyl) picolinonitrile *via* one-pot Sonogashira and decarboxylative coupling reaction, which was developed in 2008 by S. Lee.⁹ 3-Iodopyridine was employed for the Sonogashira coupling with propiolic acid, and 5-bromo-2-cyanopyridine was employed for the decarboxylative coupling.⁵¹ The coupled product was transformed into the corresponding acid and employed as a ligand for the construction of two-dimensional lead(II) coordination polymer (Scheme 66).

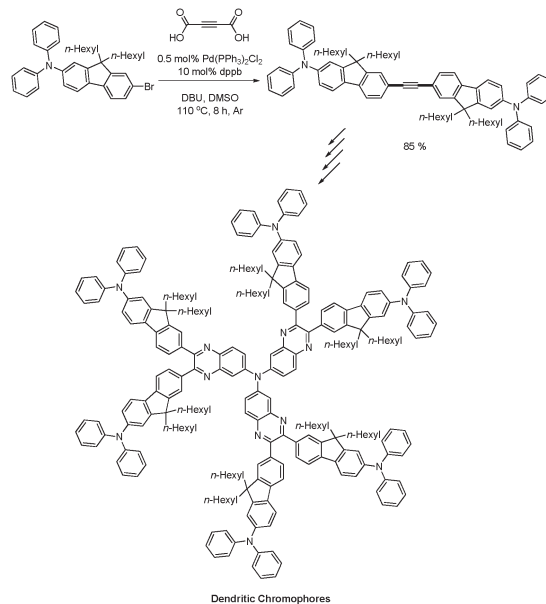

Scheme 65 Synthesis of star-shaped multipolar chromophores.

Skyrdstrup reported the synthesis of two isotopically labeled variants of the β -amyloid binding compound FSB.⁵² In the course of the synthesis of the final products, one-pot Sonogashira and decarboxylative coupling reaction were used instead of the previous three-step synthetic procedure which was Sonogashira coupling, deprotection and another Sonogashira coupling. The desired coupled product was obtained in 43% yield from 1,4-dibromo-2-fluorobenzene, 2-chloro-4-iodoaniline, and propiolic acid under a catalytic system of Pd(PPh₃)₂Cl₂ and dppf. The yield of this reaction is an impressive 81% per C–C bond formation for the four generated C–C bonds. Aryl bromide was used as the first substrate, and aryl iodide was used as the second substrate, which was opposite to the method^{9,13} employed by S. Lee (Scheme 67).

11. Conclusion

Over the past five years, great advances have been made in the decarboxylative coupling reaction of alkynyl carboxylic acids by transition-metal catalysts. Despite the many significant developments in this field, there remain a number of unsolved

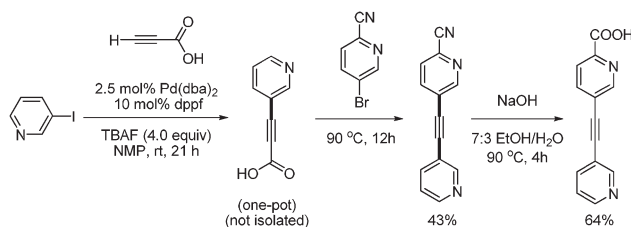

Scheme 66 Synthesis of unsymmetrically substituted heterocyclic alkyne.

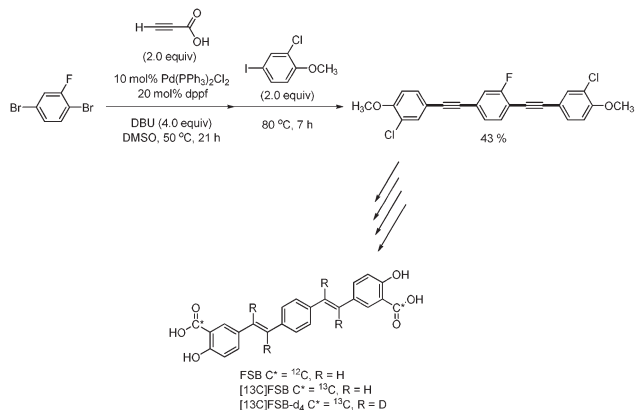

Scheme 67 Synthesis of the fibril binding compound FSB.

problems. Until now, only one example of C–H activation has been reported. In addition, no coupling with alkyl group has been developed. Therefore, further studies are needed to achieve high activity and versatility in these areas. It has been known that the decarboxylation of alkynyl carboxylic acid occurs in the absence of transition-metal catalyst.²⁰ Based on this concept, it is expected that transition-metal-free decarboxylative coupling reactions will be developed.

Acknowledgements

This research was supported by Basic Science Research Program through the National Research Foundation of Korea (NRF) funded by the Ministry of Education, Science and Technology (2012R1A1B3000871)

References

- 1 E. I. Negishi, *Handbook of Organopalladium Chemistry for Organic Synthesis*, Wiley-Interscience, New York, 2002.
- 2 A. de Meijere and F. Diederich, in *Metal-Catalyzed Cross-Coupling Reactions*, Wiley-VCH, Germany, 2nd edn, 2004.
- 3 (a) A. K. Steib, T. Thaler, K. Komeyama, P. Mayer and P. Knochel, *Angew. Chem., Int. Ed.*, 2011, **50**, 3303; (b) K.-H. Wu and H.-M. Gau, *J. Am. Chem. Soc.*, 2006, **128**, 14808; (c) G. Manolikakes, C. M. Hernandez, M. A. Schade, A. Metzger and P. Knochel, *J. Org. Chem.*, 2008, **73**, 8422; (d) M. E. Doster, J. A. Hatnean, T. Jetic, S. Modi and S. A. Johnson, *J. Am. Chem. Soc.*, 2010, **132**, 11923; (e) I. A. I. Mkhaliid, J. H. Barnard, T. B. Marder, J. M. Murphy and J. F. Hartwig, *Chem. Rev.*, 2010, **110**, 890; (f) A. Postigo and R. A. Rossi, *Org. Lett.*, 2001, **3**, 1197.
- 4 (a) O. Daugulis, H.-Q. Do and D. Shabashov, *Acc. Chem. Res.*, 2009, **42**, 1074; (b) S. H. Cho, J. Y. Kim, J. Kwak and S. Chang, *Chem. Soc. Rev.*, 2011, **40**, 5068; (c) J. Wencel-Delord, T. Droge, F. Liu and F. Glorius, *Chem. Soc. Rev.*, 2011, **40**, 4740; (d) P. B. Arockiam, C. Bruneau and P. H. Dixneuf, *Chem. Rev.*, 2012, **112**, 5879; (e) G. Song, F. Wang and X. Li, *Chem. Soc. Rev.*, 2012, **41**, 3651; (f) T. C. Boorman and I. Larrosa, *Chem. Soc. Rev.*, 2011, **40**, 1910;

- (g) J. Q. Yu and Z. J. Shi, *C–H Activation*, Springer, Berlin, Germany, 2010.
- 5 M. Nilsson, *Acta Chem. Scand.*, 1966, **20**, 423.
- 6 A. G. Myers, D. Tanaka and M. R. Mannion, *J. Am. Chem. Soc.*, 2002, **124**, 11250.
- 7 L. J. Goossen, G. Deng and L. M. Levy, *Science*, 2006, **313**, 662.
- 8 (a) N. Rodriguez and L. J. Goossen, *Chem. Soc. Rev.*, 2011, **40**, 5030; (b) R. Shang and L. Liu, *Sci. China: Chem.*, 2011, **54**, 1670.
- 9 J. Moon, M. Jeong, H. Nam, J. Ju, J. H. Moon, H. M. Jung and S. Lee, *Org. Lett.*, 2008, **10**, 945.
- 10 J. Moon, M. Jang and S. Lee, *J. Org. Chem.*, 2009, **74**, 1403.
- 11 H. Kim and P. H. Lee, *Adv. Synth. Catal.*, 2009, **351**, 2827.
- 12 W.-W. Zhang, X.-G. Zhang and J.-H. Li, *J. Org. Chem.*, 2010, **75**, 5259.
- 13 K. Park, G. Bae, J. Moon, J. Choe, K. H. Song and S. Lee, *J. Org. Chem.*, 2010, **75**, 6244.
- 14 H. J. Lee, K. Park, G. Bae, J. Choe, K. H. Song and S. Lee, *Tetrahedron Lett.*, 2011, **52**, 5064.
- 15 S. Tartaggia, O. D. Lucchi and L. J. Goossen, *Eur. J. Org. Chem.*, 2012, 1431.
- 16 K. Park, G. Bae, A. Park, Y. Kim, J. Choe, K. H. Song and S. Lee, *Tetrahedron Lett.*, 2011, **52**, 576.
- 17 A. Pyo, J. D. Kim, H. C. Choi and S. Lee, *J. Organomet. Chem.*, 2013, **724**, 271.
- 18 P. V. Reddy, P. Srinivas, M. Annapurna, S. Bhargava, J. Wagler, N. Mirzadeh and M. L. Kantam, *Adv. Synth. Catal.*, 2013, **355**, 705.
- 19 X. Li, F. Yang and Y. Wu, *J. Org. Chem.*, 2013, **78**, 4543.
- 20 A. Pyo, Y. H. Kim, K. Park, G. C. Kim, H. C. Choi and S. Lee, *Appl. Organomet. Chem.*, 2012, **26**, 650.
- 21 C. Feng and T.-P. Loh, *Chem. Commun.*, 2010, **46**, 4779.
- 22 Y. Heo, Y. Y. Kang, T. Palani, J. Lee and S. Lee, *Inorg. Chem. Commun.*, 2012, **23**, 1.
- 23 M. Yu, D. Pan, W. Jia, W. Chen and N. Jiao, *Tetrahedron Lett.*, 2010, **51**, 1287.
- 24 Y. Kim, A. Park, K. Park and S. Lee, *Tetrahedron Lett.*, 2011, **52**, 1766.
- 25 J. Park, E. Park, A. Kim, S.-A. Park, Y. Lee, K.-W. Chi, Y. H. Jung and I. S. Kim, *J. Org. Chem.*, 2011, **76**, 2214.
- 26 Z. Huang, R. Shang, Z.-R. Zhang, X.-D. Tan, X. Xiao and Y. Fu, *J. Org. Chem.*, 2013, **78**, 4551.
- 27 B. Zhao, *Org. Biomol. Chem.*, 2012, **10**, 7108.
- 28 A. Park, K. Park, Y. Kim and S. Lee, *Org. Lett.*, 2011, **13**, 944.
- 29 W. Kim, K. Park, A. Park, J. Choe and S. Lee, *Org. Lett.*, 2013, **14**, 1654.
- 30 D. Zhao, C. Gao, X. Su, Y. He, J. You and Y. Xue, *Chem. Commun.*, 2010, **46**, 9049.
- 31 J. Mao, M. Wu, G. Xie and S. Ji, *Adv. Synth. Catal.*, 2009, **351**, 2101.
- 32 X. Qu, T. Li, P. Sun, Y. Zhu, H. Yang and J. Mao, *Org. Biomol. Chem.*, 2011, **9**, 6938.
- 33 T. Li, P. Sun, H. Yang, Y. Zhu, H. Yan, L. Lu and J. Mao, *Tetrahedron*, 2012, **68**, 6413.
- 34 T. Ponpandian and S. Muthusubramanian, *Tetrahedron Lett.*, 2012, **53**, 4248.
- 35 L. Shi, W. Jia, X. Li and N. Jiao, *Tetrahedron Lett.*, 2013, **54**, 1951.
- 36 J. Choe, J. Yang, K. Park, T. Palani and S. Lee, *Tetrahedron Lett.*, 2012, **53**, 6908.

- 37 J. D. Kim, T. Palani, M. R. Kumar, S. Lee and H. C. Choi, *J. Mater. Chem.*, 2012, **22**, 20665.
- 38 (a) A. S.-Y. Lee, Y.-J. Hu and S.-F. Chu, *Tetrahedron*, 2001, **57**, 2121; (b) A. Katritzky, S. Ozcan and E. Todadze, *Org. Biomol. Chem.*, 2010, **8**, 1296; (c) E. Dalcanale and F. Montanari, *J. Org. Chem.*, 1986, **51**, 567; (d) X. Zhang, W.-Z. Zhang, X. Ren, L.-L. Zhang and X.-B. Lu, *Org. Lett.*, 2011, **13**, 2402; (e) X. Wang, Y. N. Lim, C. Lee, H.-Y. Jang and B. Y. Lee, *Eur. J. Org. Chem.*, 2013, 1867.
- 39 K. W. Anderson and S. L. Buchwald, *Angew. Chem.*, 2005, **117**, 6329.
- 40 K. Park, T. Palani, A. Pyo and S. Lee, *Tetrahedron Lett.*, 2012, **53**, 733.
- 41 K. Park, J.-M. You, S. Jeon and S. Lee, *Eur. J. Org. Chem.*, 2013, 1973.
- 42 A. Kolarovic and Z. Faberova, *J. Org. Chem.*, 2009, **74**, 7199.
- 43 W. Jia and J. Jiao, *Org. Lett.*, 2010, **12**, 2000.
- 44 J. Hu, N. Zhao, B. Yang, G. Wang, L.-N. Guo, Y.-M. Liang and S.-D. Yang, *Chem.-Eur. J.*, 2011, **17**, 5516.
- 45 S. Ranjit, Z. Duan, P. Zhang and X. Liu, *Org. Lett.*, 2010, **12**, 4134.
- 46 H. Feng, D. S. Ermolat'ev, G. Song and E. V. Van der Eycken, *J. Org. Chem.*, 2012, **77**, 5149.
- 47 A. Kolarovic, M. Schnurch and M. D. Mihovilovic, *J. Org. Chem.*, 2011, **76**, 2613.
- 48 D. E. Mendes and A. M. Schoffstall, *J. Chem. Educ.*, 2011, **88**, 1582.
- 49 T. Palani, K. Park, M. R. Kumar, H. M. Jung and S. Lee, *Eur. J. Org. Chem.*, 2012, 5038.
- 50 T.-C. Lin, Y.-H. Lee, C.-Y. Liu, B.-R. Huang, M.-Y. Tsai, Y.-J. Huang, J.-H. Lin, Y.-K. Shen and C.-Y. Wu, *Chem.-Eur. J.*, 2013, **19**, 749.
- 51 R. C. Severance, E. S. Rountree, M. D. Smith and H.-C. zur Loye, *Solid State Sci.*, 2012, **14**, 1512.
- 52 M. N. Burhardt, R. Taaning, N. C. Nielsen and T. Skrydstrup, *J. Org. Chem.*, 2012, **77**, 5357.