

The chemistry of cationic polyphosphorus cages – syntheses, structure and reactivity

Michael H. Holthausen^a and Jan J. Weigand^{*b}

Cite this: *Chem. Soc. Rev.*, 2014, 43, 6639

Received 13th January 2014

DOI: 10.1039/c4cs00019f

www.rsc.org/csr

The aim of this review is to provide a comprehensive view of the chemistry of cationic polyphosphorus cages. The synthetic protocols established for their preparation, which are all based on the functionalization of P₄, and their intriguing follow-up chemistry are highlighted. In addition, this review intends to foster the interest of the inorganic, organic, catalytic and material oriented chemical communities in the versatile field of polyphosphorus cage compounds. In the long term, this is envisioned to contribute to the development of new synthetic procedures for the functionalization of P₄ and its transformation into (organo-)phosphorus compounds and materials of added value.

1. Introduction

Discovering novel pathways for the activation and transformation of white phosphorus (P₄) is important for the ongoing search for new, systematic entries to polyphosphorus and

organo-phosphorus compounds. Especially in the realm of polyphosphorus cations methods for the preparation of species featuring a high P to substituent ratio are rare. In contrast, a systematic access to highly substituted cations R_nP_m ($n > m$) is achieved with synthetic protocols mainly based on the utilization of neutral *catena* or *cyclic* polyphosphanes R_nP_m.¹ Protocols for phosphorus-rich cations R_nP_m ($n < m$) often involve P₁-precursors and are based on the reduction of either P–Cl² or P–H bonds.³ Multiple P–P bonds are formed in these reactions giving access to elaborate P–P bonded frameworks. However, in most

^a Department of Chemistry, University of Toronto, Toronto, Canada.

E-mail: m.holthausen@utoronto.ca

^b Fachrichtung Chemie und Lebensmittelchemie, TU Dresden, Professur für Koordinationschemie, Dresden, Germany. E-mail: jan.weigand@tu-dresden.de; Tel: +49 (351) 468-42800



Michael H. Holthausen

postdoctoral stay at the TU Dresden he recently joined the research group of Prof. Douglas Stephan at the University of Toronto in Canada and obtained a Feodor Lynen Scholarship for postdoctoral researchers.

Michael H. Holthausen received his diploma degree from the WWU Münster at the end of 2009 and his Dr rer nat. in March 2013. As a PhD student in the Weigand group he was supported by a scholarship of the Fond der Chemischen Industrie. He studied the reactivity of cationic polyphosphorus cages and developed protocols for their preparation based on the activation of elemental white phosphorus by phosphenium ions. After a brief



Jan J. Weigand

of Prof. Hahn. He was awarded shortly after the Liebig scholarship of the FCI which allowed him in 2008 to start his independent career. In April 2010 he became a fellow of the Emmy Noether research program awarded by the DFG and obtained recently the Wöhler research award for young scientists. In 2012, he obtained an ERC starting grant from the European Council. Since 2013 he has been Professor at the TU University Dresden.

Jan J. Weigand obtained his diploma in chemistry in 2002 and his Dr rer nat. in 2005 from the LMU in Munich (Germany). He was awarded in 2005 the Bavarian culture prize and obtained a Lynen Scholarship from the AvH foundation for postdoctoral research at Dalhousie University in Halifax (Canada). He returned to Germany with a Lynen Return Fellowship and started his habilitation at the WWU Münster at the end of 2007 under the supervision



cases the reaction outcome is unpredictable which hampers the targeted preparation of polyphosphorus cations. Thus, a synthetic approach that takes advantage of the tetrahedral P_4 framework should allow for a targeted and systematic assembly of phosphorus-rich cations R_nP_m ($n < m$). Additionally, the application of P_4 in such conversions is of high interest, since it constitutes an important raw material in industrial chemistry and is produced on a megaton-scale nowadays.⁴ The desire to develop synthetic protocols for the more sustainable production of P-containing bulk chemicals has sparked significant academic and industrial research efforts within the last decades. Progress in the areas of transition metal⁵ and main group⁶ mediated P_4 activation has been reviewed several times. However, no account was given so far on the importance of P_4 as a starting material for the preparation of polyphosphorus cations.

The aim of this review is to provide a comprehensive view of the chemistry of cationic polyphosphorus cages.

The synthetic protocols established for their preparation, which are all based on the functionalization of P_4 , and their intriguing follow-up chemistry are highlighted. In addition, this review intends to foster the interest of the inorganic, organic, catalytic and material oriented chemical communities in the versatile field of polyphosphorus cage compounds. In the long term, this is envisioned to contribute to the development of new synthetic procedures for the functionalization of P_4 and its transformation into (organo-)phosphorus compounds and materials of added value.

In the following, black dots denote P atoms in order to provide easily comprehensible drawings of complex polyphosphorus frameworks for the reader. These frameworks may give rise to complicated, sometimes higher order, spin systems in their ^{31}P NMR spectra. Their designation is derived by assigning letters in alphabetical order starting with the resonance at the highest field. The spin systems were considered to be higher

order and consecutive letters are assigned if $\Delta\delta(P_iP_{ii})/J(P_iP_{ii}) < 10$. For $\Delta\delta(P_iP_{ii})/J(P_iP_{ii}) > 10$, the spin system is considered to be pseudo first order and the assigned letters are separated. However, if a group of similar compounds is discussed, only one spin system is mentioned for the sake of clarity. All cationic polyphosphorus cages presented here are obtained by functionalization of P_4 . Mostly, phosphonium ions or cationic phosphorus species which formally serve as a phosphonium ion source are used for this functionalization. It is of high importance for the reader to be aware of the general reactivity pattern of P_4 and the general characteristics of phosphonium ions. Thus, a brief insight into both fields is given in the first two sections.

2. P_4 activation pathways

In order to gain an in depth understanding of the reactions of P_4 and main group element compounds, it is crucial to understand the properties of the P_4 tetrahedron. The bonding in P_4 is almost “cluster-like”, strongly delocalized and mostly effected through 3p atomic orbitals. Interestingly, P_4 shows spherical aromaticity and is virtually unstrained despite acute bond angles of 60° .⁷ Generalized reactions of P_4 with nucleophiles (Nu^-), electrophiles (El^+) and ambiphiles (Ab) are shown in Fig. 1. Radical reactions involving P_4 are excluded. A nucleophile (Nu^-) interacts with the LUMO of P_4 (-1.8 eV),⁷ which leads to the rupture of a P–P bond giving butterfly-type bicyclo[1.1.0]tetraphosphane **A** (Fig. 1I). The reactions of P_4 with nucleophiles were intensely investigated using an array of organo-alkali and organo-alkali earth reagents.⁶ However, in many cases the formation of a derivative of **A** only constitutes the first step of a reaction sequence which ultimately leads to the degradation of P_4 to P_1 -compounds.⁶ Only a few reactions involving a selective cleavage of only a single bond in the P_4 tetrahedron are reported.



Fig. 1 Generalized reactions of P_4 with nucleophiles (I, Nu^-), electrophiles (II, El^+), predominantly nucleophilic ambiphiles (III, Ab), and predominantly electrophilic ambiphiles (IV, Ab); **A–D** illustrate structural motifs obtained after reaction with the aforementioned species.



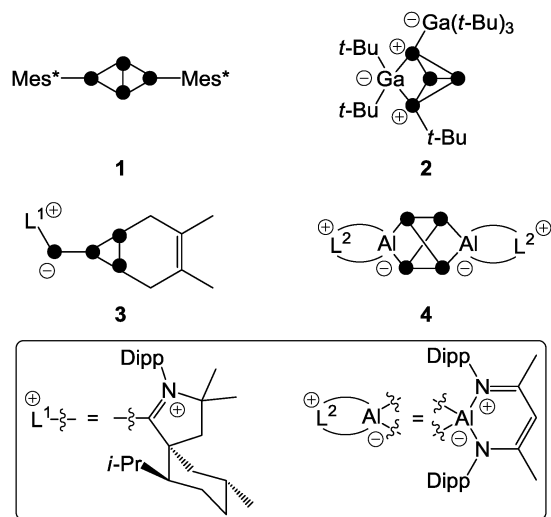

Fig. 2 Examples of polyphosphorus compounds obtained by the functionalization of P_4 by nucleophiles (1), electrophiles (2), predominantly nucleophilic ambiphiles (3), and predominantly electrophilic ambiphiles (4).

One is the reaction of Mes^*Li ($Mes^* = 2,4,6$ -tri-*tert*-butylphenyl) with one equivalent of P_4 yielding a tetraphosphanide intermediate of type A. Subsequent reaction with Mes^*Br yields the butterfly-type species 1 (Fig. 2).⁸ Further degradation of 1 is prevented by the sterically demanding Mes^* -groups. Nucleophiles based on silicon, main group 5 or main group 6 elements were also employed.⁶ An electrophile may attack at a non-bonding orbital of lone pair character (HOMO – 6, –7.5 eV)⁷ which results in the formation of compounds of type B (Fig. 1II a). Alternatively, an electrophile may attack at a bonding orbital at one of the edges of the tetrahedron (HOMO, –6.7 eV; Fig. 1II b). However, this mode of attack is commonly less productive for main group element centered electrophiles and is not depicted. In total, only very few reactions with electrophiles were reported due to the low nucleophilicity of P_4 .⁹ One example constitutes the reaction of P_4 with two equivalents of the sterically encumbered Lewis acid $Ga(t-Bu)_3$. This yields compound 2; however, mechanistic details regarding its formation were not reported (Fig. 2).¹⁰

The utilization of ambiphilic main group element compounds (Ab) for the activation of P_4 represents a rather new synthetic approach. Reactions of P_4 with ambiphiles can be divided into two categories assuming an asynchronous process with two consecutive steps. The first category comprises reactions of P_4 with predominantly nucleophilic ambiphiles. Similar to the reactions of P_4 and nucleophiles, intermediate A' is obtained in the first step of the reaction. Subsequently, A' rearranges to *cyclo*-triphosphirene derivative C (Fig. 1III). The rearrangement is attributed to the propensity of Ab to accept electron density from the adjacent P atom which formally leads to the formation of an Ab–P double bond. Carbenes are ambiphiles with a predominantly nucleophilic character.¹¹ Two types of carbenes, *i.e.* N-heterocyclic carbenes (NHC) and cyclic or acyclic alkyl amino carbenes (cAAC or aAAC), were investigated in reactions with P_4 by the research group of Bertrand.¹²

The formation of an intermediate of type A' was confirmed by DFT calculations¹² and of type C by trapping experiments with 2,3-dimethylbutadiene yielding [2+4] *cyclo*-addition product 3 (Fig. 2, *e.g.* $L^1 = cAAC$).

The second category comprises reactions of P_4 with predominantly electrophilic ambiphiles. By analogy with the reactions involving electrophiles, the first step of the reaction is an electrophilic attack of Ab yielding an intermediate B' (Fig. 1). Subsequently, B' rearranges to a bicyclo[1.1.0]tetraphosphane D featuring a bridging Ab moiety (IV). This reaction sequence equals the formal insertion of the ambiphile in one of the P–P bonds of the P_4 tetrahedron. P_4 functionalization involving a predominantly electrophilic ambiphile is an experimentally more widespread approach. Monovalent group 13 element compounds with the oxidation state +I are a class of substances that are widely used in such transformations.¹³ The first type of such a structural motif was achieved by Roesky and coworkers by reacting P_4 with two equivalents of Al(I) compound AlL^2 ($L^2 = CH\{(CMe)(2,6\text{-}i\text{-}Pr_2C_6H_3N)\}_2$).¹³ The formal insertion of AlL^2 into one P–P bond of P_4 is assumed to give an intermediate of type B' in the first step. However, the insertion of a second equivalent of AlL^2 into the opposing P–P bond of the P_4 tetrahedron occurs rapidly yielding the two-fold insertion product 4 (Fig. 2). In addition, P_4 activation by predominantly electrophilic silylenes,¹⁴ disilylenes,¹⁵ phosphasilylenes,¹⁶ and a bis(stannylenes)¹⁷ was reported. Reactions of P_4 with phosphonium cations (R_2P^+) are also classified as P_4 functionalization with predominantly electrophilic ambiphiles. They will be thoroughly discussed within this review from an experimental as well as a mechanistic point of view.

3. Syntheses and characteristics of phosphonium ions

The term phosphonium ion describes a cation featuring a di-coordinated, positively polarized P atom.¹⁸ Phosphonium ions reveal a lone pair of electrons and a formally vacant p-type orbital, and thus, they constitute carbene analogues.¹¹ The stability of phosphonium ions strongly depends on their substituents. While aryl- or alkylphosphonium ions R_2P^+ (7^+ , Fig. 3) are strongly electrophilic and generally elusive, a large series of phosphonium ions bearing amino-substituents ($(R_2N)_2P^+$ ($R = \text{alkyl, aryl}$)) are known.¹⁸ Three methods for their preparation are mainly reported throughout the literature. Halide abstraction from the corresponding halo-phosphane precursor is the most commonly used synthetic protocol.¹⁸ Further methods



Fig. 3 Distinct types of phosphonium ions featuring two (5^+) or one (6^+) stabilizing amino-substituents and elusive, non-stabilized phosphonium ion 7^+ ($R, R' = \text{alkyl, aryl}$).



constitute the protolysis of P–N single bonds by Brønsted acids and the coordination of strong Lewis acids to P–N double bonds.¹⁸

The increased stability of phosphonium ions ($(R_2N)_2P^+$ (5^+ , Fig. 3) stems from a lowered electrophilicity due to donation of π -electron density from the lone pair of electrons at the nitrogen atoms to the vacant p-type orbital at the P atom.¹⁹ Phosphonium ions of type 6^+ featuring one amino-substituent are borderline cases between both of the aforementioned types and are only scarcely investigated. Only a few fully characterized derivatives are reported to date bearing either (pseudo-) halogens²⁰ or sterically demanding aryl-moieties²¹ as the second substituent R' on phosphorus (Fig. 3).

A phosphonium ion bearing only alkyl- or aryl-substituents has not been isolated to date.¹⁸ The reaction of phosphanes bearing organo- and chloro-groups $R_nPCl_{(3-n)}$ ($n = 1, 2$) and a halide abstracting agent (e.g. Me_3SiOTf , $GaCl_3$, or $AlCl_3$) in the appropriate stoichiometry usually results in the formation of phosphanylphosphonium ions.¹ This is best exemplified by the reaction of Ph_2PCl and $GaCl_3$ in a 2:1 stoichiometry which yields $8[GaCl_4]$ (Scheme 1).²²

Two mechanisms for the formation of 8^+ are conceivable. Firstly, Ph_2PCl reacts with $GaCl_3$ as a halide abstracting agent giving a transient Ph_2P^+ -phosphonium ion. This reacts with the second equivalent of Ph_2PCl yielding 8^+ . The second and in the author's opinion more likely mechanism proceeds *via* the zwitterionic intermediate **9** which features a Ph_2PCl molecule donating electron density from its lone pair of electrons to the lobes of the antibonding $\sigma^*(P-Cl)$ orbital of a second molecule of Ph_2PCl . Subsequently, chloride abstraction by $GaCl_3$ yields 8^+ without an intermediary formation of a free Ph_2P^+ -phosphonium ion. The phosphoniumyl-moiety in 8^+ is easily substituted when 8^+ is reacted with phosphanes of higher basicity than the leaving group.¹ This is illustrated by the reaction of 8^+ with Ph_3P yielding 10^+ and Ph_2PCl (Scheme 2, left).²³ Other Lewis bases are also suitable as nucleophiles. This is illustrated by the reaction of 8^+ with 1,3-di-iso-propyl-4,5-dimethylimidazol-2-ylidene (L^3) which yields the imidazoliumyl-substituted phosphane 11^+ .²³

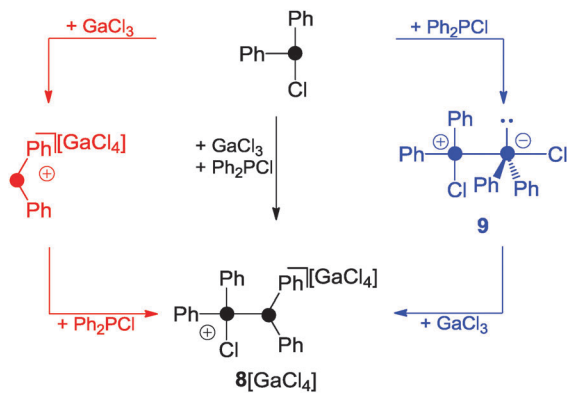

Scheme 1 Synthesis of $8[GaCl_4]$ by the reaction of Ph_2PCl and $GaCl_3$ in 2:1 stoichiometry and possible reaction sequences giving $8[GaCl_4]$ either *via* free Ph_2P^+ -phosphonium ion (red) or zwitterion **9** (blue).

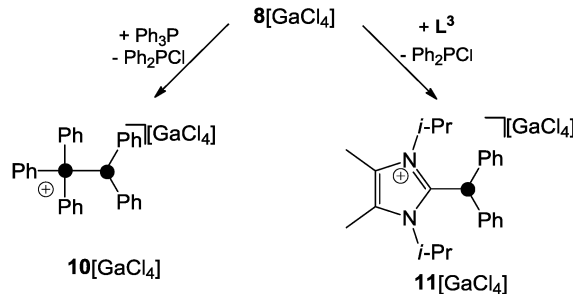

Scheme 2 Substitution of the phosphoniumyl-moiety of 8^+ by Lewis-bases.

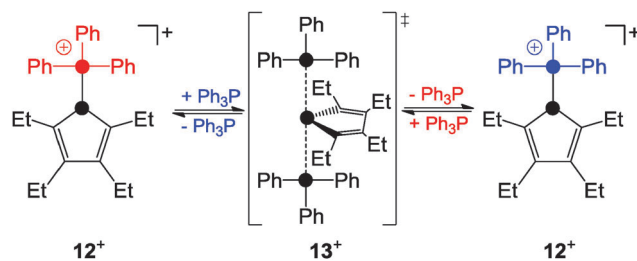

Scheme 3 S_N2 -type substitution of the phosphoniumyl-moiety in 12^+ .

Detailed investigations of mixtures of phosphanyl-phosphonium ion 12^+ and Ph_3P revealed second-order kinetics for the exchange process of Ph_3P consistent with a S_N2 -type pathway (Scheme 3).²⁴

This was further supported by quantum chemical calculations which suggested the phosphoranide-type transition state **13** for the substitution process.²⁴ In contrast, the phosphanyl-phosphonium ion 14^+ , which is formed *via* the reaction of phosphonium ion 15^+ and PMe_3 , was reported to favour a dissociative S_N1 -type reaction pathway in substitution reactions (Scheme 4).²⁵

For phosphanylphosphonium ions such as those described above the term “ligand stabilized phosphonium ions” is frequently used in the literature while the described substitution reactions are also called “ligand exchange” reactions.¹ Independent of any such controversy, however, these distinct points of view are based on the labile P–P bond observed in phosphanylphosphonium ions. This allows for the transfer of R_2P^+ -moieties (formally phosphonium ions) between distinct Lewis bases (e.g. phosphanes, carbenes or P_4). Thus, for reasons of simplification, phosphanylphosphonium ions will be regarded as “sources of phosphonium ions”¹ throughout this review.

Phosphanylphosphonium ions were frequently used as phosphonium ion sources. The reaction of a mixture of Me_2PCl



Scheme 4 S_N1 -type dissociation of phosphanylphosphonium ion 14^+ .



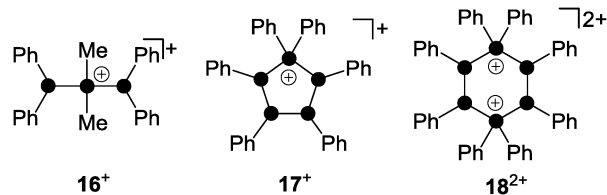

Fig. 4 Polyphosphorus cations 16^+ , 17^+ and 18^{2+} obtained via the formal insertion of R_2P^+ -phosphenium ions ($R = \text{Me}, \text{Ph}$) into the P–P bond of $(\text{Ph}_2\text{P})_2$, $(\text{PhP})_4$ and $(\text{PhP})_5$.

and Me_3SiOTf with diphosphane $(\text{Ph}_2\text{P})_2$ gave diphosphanylphosphonium ion 16^+ as a triflate salt (Fig. 4).²⁶ Species 16^+ is formally derived from the insertion of a Me_2P^+ -phosphenium ion into the P–P bond of the diphosphane $(\text{Ph}_2\text{P})_2$. Mixtures of Ph_2PCl and Me_3SiOTf with the *cyclo*-phosphanes $(\text{PhP})_4$ or $(\text{PhP})_5$ give in both cases the *cyclo*-tetraphosphanylphosphonium ion 17^+ .

A ring expansion is observed in the reaction with $(\text{PhP})_4$ whereas a 5-membered ring is retained in the reaction involving $(\text{PhP})_5$ via an unknown redistribution process.²⁶ Both reactions proceed via the formal transfer of a Ph_2P^+ -phosphenium ion from the intermediary formed phosphanylphosphonium ion 8^+ . In both cases 17^+ is exclusively formed which demonstrates the thermodynamic preference of the five-membered ring over the six-membered alternative. The highly reactive, cyclic six-membered dication 18^{2+} is only obtained by employing a melt approach.²⁷ Solvent-free mixtures of Ph_2PCl and GaCl_3 provide room temperature molten media. These melts represent a powerful source of phosphenium ions Ph_2P^+ .²⁸

4. Cationic homoleptic polyphosphorus cages

For decades the investigation of homoleptic polyphosphorus cations was limited to mass spectroscopy²⁹ and quantum chemical calculation³⁰ in the gas phase. Homoleptic P_n^+ cations are paramagnetic if the number of P atoms n is even. In the case of an odd number of P atoms the respective cation is diamagnetic. In general, the paramagnetic series of polyphosphorus cations is less stable. In the odd-membered series, the smaller P_n^+ cations 19^+ ($n = 5$) and 20^+ ($n = 7$) may be described as electron-deficient Wade clusters whereas larger P_n^+ -cages ($n \geq 9$) feature electron-precise Zintl-type structures. According to Wade's rules, a square pyramidal structure is anticipated for cation 19^+ (Fig. 5, *nido*-cluster). Such a structure was confirmed as the most stable isomer by means of quantum chemical calculations.^{30a} The structural motif of the second most stable isomer 19^{*+} (34.7 kcal mol⁻¹ higher in energy) does not follow Wade's rules and shows a di-coordinated P atom. The most stable isomer of P_7^+ -cage 20^+ is a tricapped trigonal prism that is missing two of the capping vertices (*arachno*-cluster). A second isomer, which is only slightly higher in energy (20^{*+} , 2.0 kcal mol⁻¹), shows the P_5^+ -cage motif of 19^+ and a three-membered P ring which are both fused by a bridging

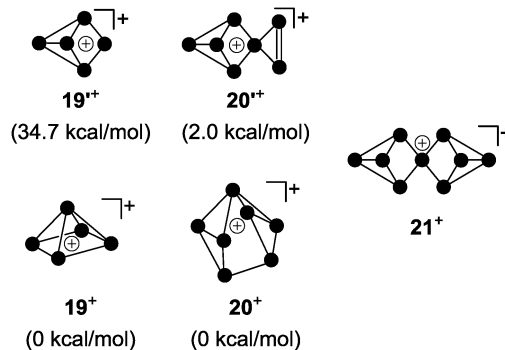
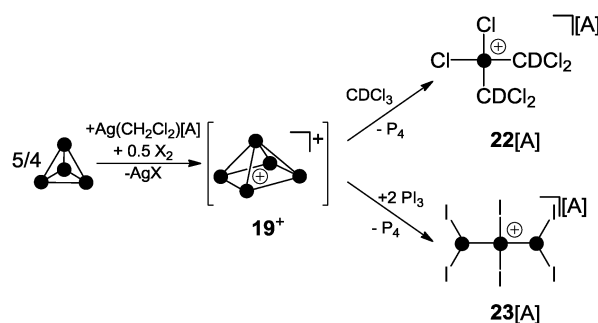

Fig. 5 Anticipated structures of homoleptic, diamagnetic polyphosphorus cations 19^+ , 20^+ and 21^+ .

phosphonium moiety. The P_9^+ -cage 21^+ , which is composed of two P_4 -moieties fused by a phosphonium moiety, is one of the most stable homoleptic polyphosphorus cations according to quantum chemical calculations (Fig. 5).^{30b}

Krossing and co-workers were the first to report evidence for the existence of homoleptic polyphosphorus cations in the condensed phase.³¹ The attempted oxidation of P_4 with I_2 or Br_2 in the presence of $\text{Ag}(\text{CH}_2\text{Cl}_2)[\text{A}]$ ($\text{A} = \text{Al}(\text{OC}(\text{CF}_3)_3)_4$) was suggested to proceed via the intermediary formation of P_5^+ -cage cation 19^+ (Scheme 5).³² However, cation 19^+ is highly reactive and reacts with the solvent to give phosphonium ion 22^+ as one of the main products. Cation 22^+ forms via elimination of P_4 and two-fold insertion into C–Cl bonds of CDCl_3 molecules which was used as solvent. In the case of I_2 as oxidant, P_4 reacts partially to give PI_3 which was suggested to react with intermediate 19^+ to give P_4 and the bis(phosphanyl)-substituted phosphonium ion 23^+ . Experimental evidence confirming the presence of 19^+ in the reaction mixtures was not obtained; however, the suggested reaction pathways are in accordance with quantum chemical calculations.³² The nitrosonium salt $[\text{NO}][\text{A}]$ ($\text{A} = \text{Al}(\text{OC}(\text{CF}_3)_3)_4$) was also investigated as a possible one electron oxidant. However, the reaction of P_4 with $[\text{NO}][\text{A}]$ yields P_4NO^+ -cage compound $24[\text{A}]$ via insertion of the nitrosonium cation into a P–P bond (Scheme 6).³³

Although X-ray structure determination of compound $24[\text{A}]$ was not successful, the molecular structure is confirmed by spectroscopic data and computational investigations. The theoretical



Scheme 5 Oxidation of P_4 with I_2 or Br_2 in the presence of $\text{Ag}(\text{CH}_2\text{Cl}_2)[\text{A}]$ via P_5^+ -cage intermediate 19^+ ; $\text{A} = \text{Al}(\text{OC}(\text{CF}_3)_3)_4$.



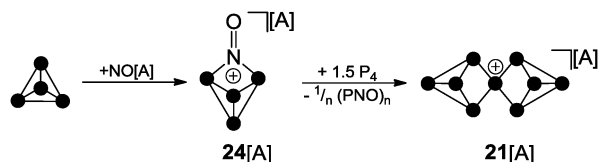

Scheme 6 Reaction of P₄ and NO[A] yielding P₄NO⁺-cage **24**[A] and subsequent reaction with P₄ yielding P₉⁺-cage compound **21**[A]; A = Al(OC(CF₃)₃)₄.

investigations suggested a two-step mechanism indicating the HOMO of P₄ and a π*-type LUMO at NO⁺ as the interacting frontier orbitals (II b, Fig. 1).³³ Similar results were obtained utilizing the carborate salt NO[HCB₁₁Cl₁₁].³⁴ The reaction of P₄NO⁺-cage compound **24**[A] with additional 1.5 equivalents of P₄ was reported to yield P₉⁺-cage compound **21**[A] which is the first isolated salt of a homoleptic phosphorus cation (Scheme 6).³⁵

The reaction proceeds very likely *via* extrusion of 1/n (PNO)_n and intermediary formation of a P₃⁺-species. The P₉⁺ cation **21**⁺ is obtained upon reaction of the latter with 1.5 equivalents of P₄ *via* an unknown reaction mechanism. The ³¹P NMR spectrum of cation **21**⁺ shows a characteristic A₂A'₂BC₂C'₂ spin system which confirms the D_{2d} symmetric Zintl-type structure. Despite the electron precise Lewis formula of eight neutral, three-coordinated and one cationic, four-coordinated P atom the charge is almost evenly distributed over all nine atoms according to quantum chemical calculations.³⁵

5. Cationic polyphosphorus cages featuring halogen-substituents

The oxidation of Ag(I) complex **25**[A] (A = Al(OC(CF₃)₃)₄) featuring two intact P₄ ligands with elemental iodine at low temperatures gives rise to interesting binary PI cations. The P₅I₂⁺-cage **26a**⁺ was observed in the reaction mixture at -78 °C together with PI₃ and P₄ (Scheme 7).³⁶ However, on raising the temperature above -40 °C, decomposition of **26a**⁺ was observed, leading to the formation of P₃I₆⁺ (**23**⁺) and unidentified by-products.

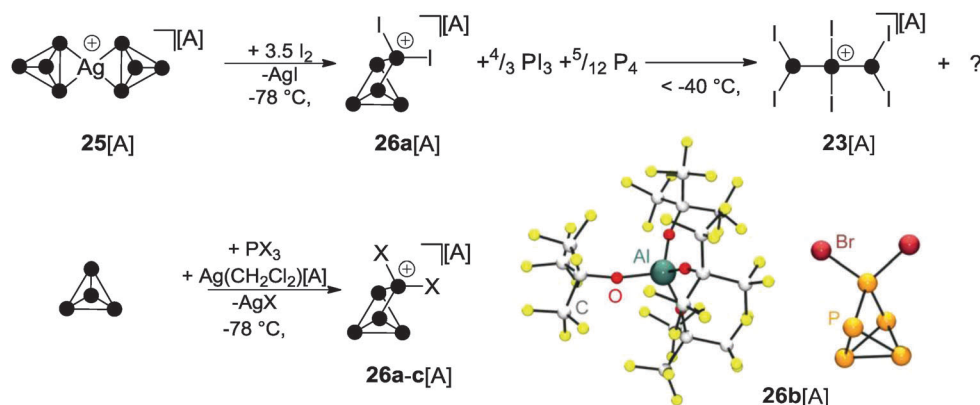

Scheme 7 Oxidation of Ag(I) complex **25**[A] with I₂ at low temperatures giving intermediary P₅I₂⁺-cage **26a**⁺ (top), targeted syntheses of P₅X₂⁺-cages **26a-c**⁺ (X = I, Br, Cl) by the reaction of P₄, PX₃ and Ag(CH₂Cl₂)[A] and molecular structure of **26b**[A] (bottom); A = Al(OC(CF₃)₃)₄.

A proposed reaction mechanism indicates the partial oxidation of the P₄ ligands in **25**⁺ by I₂ to give PI₃.³⁶ The latter reacts with Ag[A] (A = Al(OC(CF₃)₃)₄) *via* halide abstraction to give AgI and formally the phosphonium ion PI₂⁺. This highly reactive, predominantly electrophilic ambiphile reacts with white phosphorus *via* insertion in one of the P–P bonds of the P₄ tetrahedron yielding the P₅I₂⁺-cage **26a**⁺. Likewise, according to the observations described in Section 3, a mechanism involving the formation of phosphanylphosphonium ion P₂I₅⁺ can also be considered. Here, P₂I₅⁺ is assumed to transfer a PI₂⁺ phosphonium ion to P₄ and, thus, serves as a phosphonium ion source. Upon warming the reaction mixture, the excess of PI₃ reacts with P₄ to yield diphosphane P₂I₄ in a conproportionation reaction. The diphosphane reacts with **26a**⁺ *via* transfer of the phosphonium ion PI₂⁺. This gives P₄ and the P₃I₆⁺ cation **23**⁺ which is formed upon insertion of the PI₂⁺ ion into the P–P bond of P₂I₄. On the basis of these observations, a synthetic protocol for the targeted preparation of P₅X₂⁺-cages was developed (Scheme 7).^{36,37} Thus, white phosphorus reacts with PX₃ (X = I, Br) in the presence of Ag(CH₂Cl₂)[A] as a halide abstracting agent and salts of cage cations **26a**⁺ and **26b**⁺ can be isolated in good yield. However, utilizing PCl₃, the formation of the respective cation **26c**⁺ was observed only in trace amounts since it readily decomposes in the reaction mixture.³⁸ The molecular structure of **26b**⁺ is shown in Scheme 7. The structural motif of the P₅-core of the P₅X₂⁺-cage was unprecedented and was not previously observed as part of the many known polyphosphides and organo-polyphosphanes.

6. Cationic polyphosphorus cages featuring alkyl- and aryl-groups

A versatile approach to cationic polyphosphorus cages featuring alkyl- and aryl-groups represents the utilization of dichlorophosphanes RPCL₂ (R = alkyl, aryl) instead of PX₃ (X = I, Br, Cl).³⁹ Mixtures of dichlorophosphanes RPCL₂ and a strong Lewis acid (GaCl₃, AlCl₃) as a halide abstracting reagent can be utilized as the source for the phosphonium ion RPCL⁺. In the presence of P₄, insertion into one of the P–P bonds takes place, giving access to



a series of RP_5Cl^+ -cages featuring distinct substituents R.³⁹ Mixtures of dichlorophosphanes and AlCl_3 were previously utilized for the *in situ* formation of phosphonium ion salts $[\text{RPCl}][\text{AlCl}_4]$ and subsequent syntheses of various phosphorus heterocycles.⁴⁰ However, neither free phosphonium ions nor respective phosphonium ion sources could be verified. In some cases, the formation of Lewis acid–base complexes of the type $m\text{RPCl}_2 \cdot n\text{AlCl}_3$ ($n = 1, 2$; $m = 1, 2$) was suggested.⁴¹ Detailed investigations of mixtures of mono- and dichlorophosphanes in the presence of Lewis acids revealed the formation of chlorophosphanylchlorophosphonium ions of type 27^+ (Fig. 6).⁴² In most cases, characteristic $^1\text{J}(\text{PP})$ coupling constants were observed by ^{31}P NMR spectroscopy at ambient temperature.

However, the spectra of mixtures of dichlorophosphanes and Lewis acids in CH_2Cl_2 were less informative and showed in most cases only broad resonances.⁴² A systematic study based on Raman and ^{31}P NMR spectroscopy of mixtures of RPCl_2 and GaCl_3 in fluorobenzene applying varying stoichiometries gave important insight into these reactions.³⁹ Depending on the ratio of the reactants and the substituent R in RPCl_2 , mixtures of the structurally distinct species 28^+ , 29^+ and 30 were formed (Fig. 6).

The classical Lewis acid–base adducts of type 30 are only formed in reaction mixtures involving dichlorophosphanes RPCl_2 featuring alkyl-substituents R. The formation of non-classical adducts of type $30'$ is not observed and is unlikely according to quantum chemical calculations.³⁹ This is further supported by the isolation and structural characterization of 30a ($\text{R} = t\text{-Bu}$), which was proven to form a classical Lewis acid–base adduct. An increasing amount of phosphanylphosphonium ions of type 28^+ is formed with decreasing steric demand of the substituent R ($t\text{-Bu} > \text{Cy} > i\text{-Pr}$). The formation of cations of type 29^+ is observed when the basicity and the steric requirements of the dichlorophosphanes are further reduced ($\text{R} = \text{Et}, \text{Me}, \text{Ph}$). Such cations are the result of adduct formation between GaCl_3 and the phosphane moiety of phosphanylphosphonium ions of type 28^+ . Most mixtures show dynamic exchange indicating a possible interconversion of species 28^+ , 29^+ and 30 .³⁹ The exchange rates of these processes strongly depends on the concentration of GaCl_3 . In the reaction mixtures equilibrium dissociation of the GaCl_4^- anion to free GaCl_3 and Cl^- occurs. The dynamic exchange is linked to these chloride anions which nucleophilically attack phosphanylphosphonium species yielding

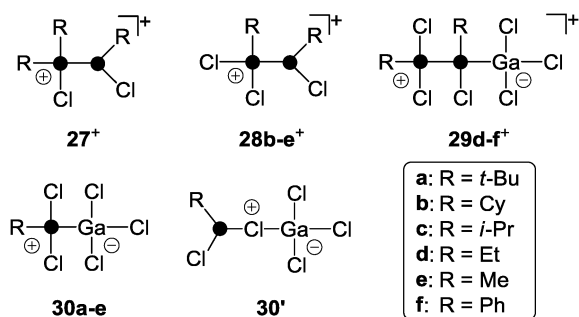

Fig. 6 Phosphanylphosphonium ion derivatives 27^+ – 29^+ and Lewis acid–base adduct 30 (classical) and $30'$ (non-classical); R = alkyl, aryl.

the phosphane starting materials in a back reaction. By using an excess of GaCl_3 the GaCl_4^- forms higher gallates (Ga_2Cl_7^- or $\text{Ga}_3\text{Cl}_{10}^-$) and the concentration of free chloride anions is reduced.⁴³

Quantum chemical calculations were carried out to determine which of the observed species serves as the phosphonium ion source in a reaction with P_4 . According to these results,⁴⁴ the formation of RP_5Cl^+ -cages *via* a free phosphonium ion RPCl^+ can be excluded. Attempts to calculate a feasible reaction mechanism from adducts 30 or $30'$ as sources of phosphonium ions were not successful. Thus, the reaction of P_4 with methyl-substituted phosphanylphosphonium derivative 28e^+ was investigated (Fig. 7). A single step insertion of the phosphonium moiety into a P–P bond of the P_4 tetrahedron is viable and the calculated energy profile of the reaction path is denoted in black. In addition, a two-step reaction pathway is feasible as well (energy profile is shown in red).

The two step reaction pathway proceeds *via* butterfly-type compound 31 as an intermediate (bottom, Fig. 7). The single step transfer of the phosphonium moiety in $28\text{e}^+[\text{GaCl}_4^-]$ and insertion thereof into a P–P bond of P_4 shows an energy barrier of $27.4 \text{ kcal mol}^{-1}$ (TS1) and is energetically viable. In the light of recent mechanistic studies on the reaction of isoelectronic silylenes with P_4 ,^{7a} this is best understood as a combined electrophilic and nucleophilic attack of the phosphonium moiety. On the one hand the P–P bond of P_4 (HOMO) nucleophilically attacks the p-type orbital of the phosphonium moiety. On the other hand the lone pair of electrons of the phosphonium moiety donates electron density to the LUMO of the P_4 tetrahedron which corresponds to p-orbitals situated perpendicular to the P_4 lone pairs.⁷ It was found that a lower barrier reaction pathway is possible if 28e^+ does not act as a nucleophile. Instead, a chloro-substituent of the GaCl_4^- anion nucleophilically attacks the P_4 tetrahedron along with the electrophilic attack of the phosphonium moiety of 28e^+ on P_4 . This leads to the slightly endothermic formation of the intermediate 31 ($15.6 \text{ kcal mol}^{-1}$) *via* transition state TS2 ($17.7 \text{ kcal mol}^{-1}$). Compound 31 reveals a butterfly-type structure featuring a chloro-substituent in an *exo*-position and a phosphanyl-substituent in an *endo*-position. Finally, 31 reacts *via* TS3 ($16.3 \text{ kcal mol}^{-1}$), which shows only a very low energy barrier. This step proceeds *via* the intramolecular nucleophilic attack of the phosphanyl-substituent on the chloro-substituted P atom. This eliminates the GaCl_4^- anion and leads to the formation of the P_5^+ -cage cation 32e^+ .

Despite their different compositions 1 : 1 mixtures of RPCl_2 and a Lewis acid ECl_3 ($\text{E} = \text{Al}, \text{Ga}$) in fluorobenzene are potent sources of reactive phosphonium ion RPCl^+ equivalents, which insert formally into P–P bonds of P_4 .³⁹ Dissolution of P_4 in these mixtures yielded white to yellowish precipitates of the corresponding RP_5Cl^+ -cage salts for a large range of different alkyl- and aryl-substituents R ($32\text{a–h}^+[\text{GaCl}_4^-]$, Scheme 8).

All compounds are obtained in almost quantitative yield and high purity. In contrast to the halogen-substituted species $26\text{a–c}[\text{A}]$, they are stable in the solid state or when dissolved in non-coordinating solvents at ambient temperature.^{36,37} The cations 32a–h^+ show characteristic ^{31}P NMR spectra. Iterative line shape



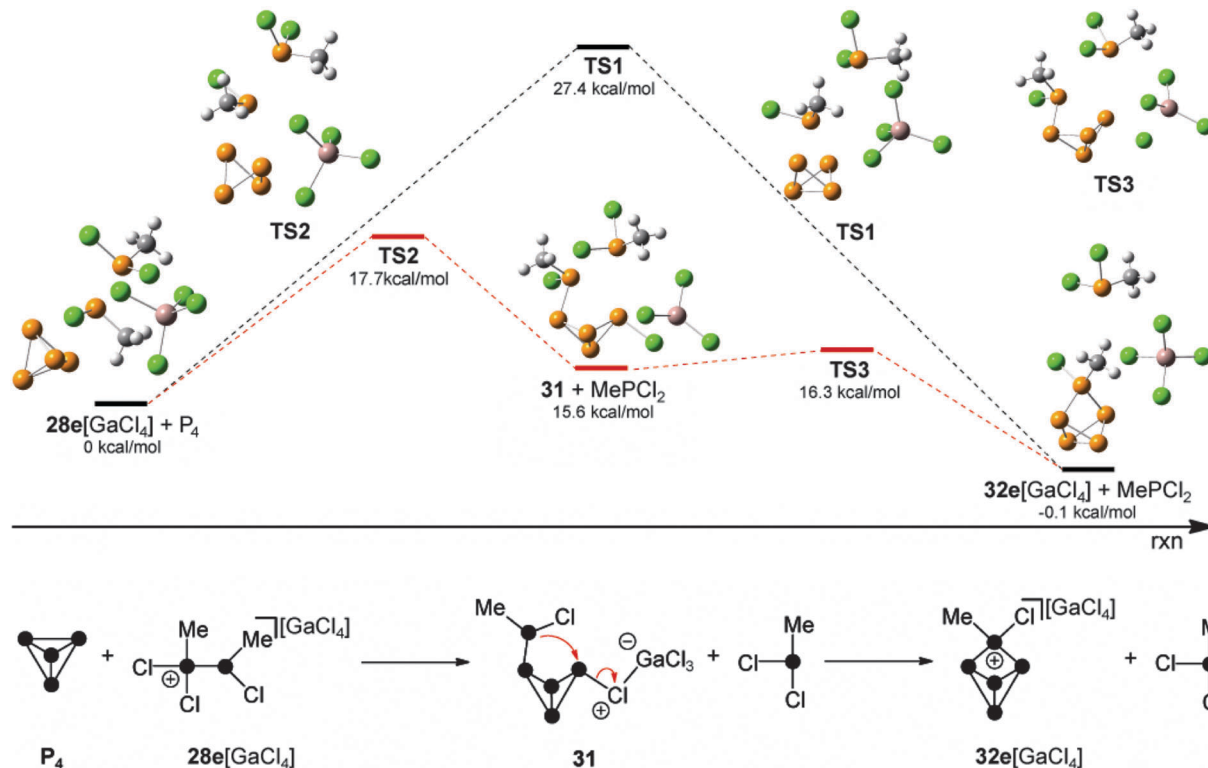
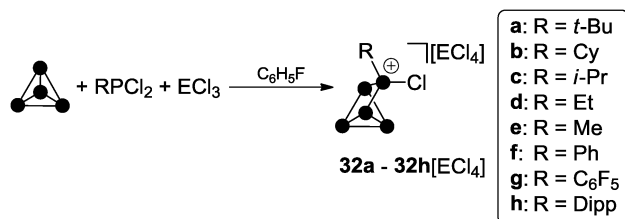

Fig. 7 Calculated reaction pathways for the reaction of **28e**[GaCl₄] and P₄; calculated differences of the enthalpies at 298.15 K (ΔH_{298}) are given for the optimized structures of MP2/6-31G(d) and the optimized structures of **28e**[GaCl₄] + P₄ were defined as 0 kcal mol⁻¹.



Scheme 8 Preparation of compounds **32a–h**[EC₁₄] from P₄, R_nPCl₂ and EC₁₃ (E = Ga, Al; R = alkyl, aryl) in fluorobenzene.

analysis of the observed spin systems gave chemical shifts and coupling constants in accordance with C_s symmetric RP₅Cl⁺-cages with four chemically non-equivalent phosphorus nuclei. All cages possess a mirror plane which includes the tetra-coordinated P atom and both P atoms opposing the former. Due to the reduced symmetry compared to the C_{2v}-symmetric P₅X₂⁺-cages **26a–c**⁺ an ABM₂X spin system is observed for **32a–d**⁺ and an ABM₂ spin system for **32e–h**⁺. Due to the similar geometry of the P₅⁺-core in all cations, the respective ¹J(PP) and ²J(PP) coupling constants deviate only marginally. However, the chemical shifts are strongly dependent on the substituent R attached to the RP₅Cl⁺-cage (Fig. 8). The P_A and P_B atoms exhibit characteristic low field resonances at approximately –275 ppm. The assignment of the A and B part to the respective P nuclei is based on the observed coupling pattern. First, the non-symmetrically substituted P₅⁺-cage is divided by a plane spanned by the tetra-coordinated and both adjacent P atoms into a H_{Cl}- and H_R-hemisphere (Fig. 9).

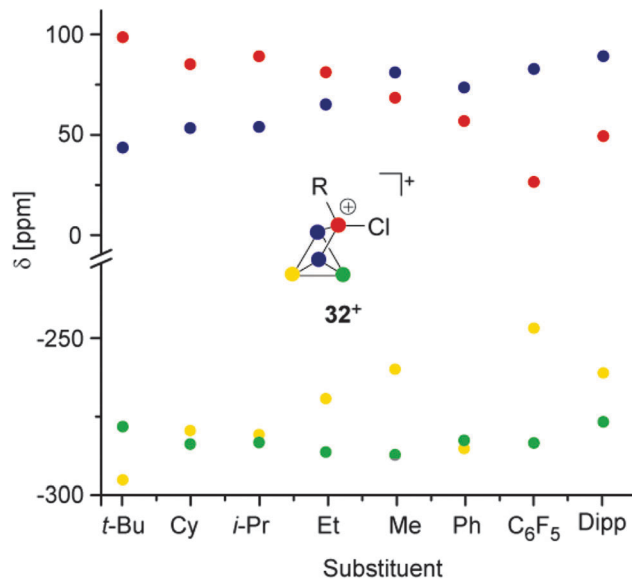

Fig. 8 Plot of the ³¹P NMR chemical shifts of RP₅Cl⁺-cages **32a–h**⁺ versus their alkyl- or aryl-substituent.

The H_{Cl}-hemisphere contains the chloro-substituent and the H_R-hemisphere the alkyl- or aryl-substituent. Within the series of cations **32a–h**⁺ the P atom located in the H_{Cl}-hemisphere shows values of ¹J(PP) and ²J(PP) coupling constants which are reminiscent of those of P₅X₂⁺-cages **26a–c**⁺.^{36,37} Accordingly, the P atom located in the H_R-hemisphere reveals one- and



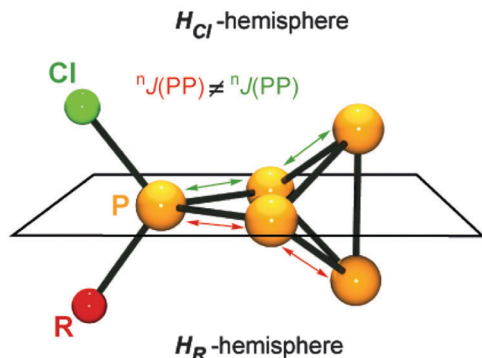

Fig. 9 Definition of the H_{Cl} - and H_R -hemisphere in cations $32a-h^+$. The tetra-coordinated P atom and the adjacent P atoms span a plane. The tri-coordinated P atom above the plane is within the H_{Cl} -hemisphere, and the P atom below the plane is in the H_R -hemisphere.

two-bond P–P coupling constants similar to the values observed for the respective $R_2P_5^+$ -cages. In addition, the former group of P atoms experiences the spatial proximity of the chloro-group, and, therefore, shows similar chemical shifts (marked in green, Fig. 8). In contrast, the P atoms in the H_R -hemisphere show resonances in a much larger chemical shift range. This is attributed to the distinct electronic parameters of the substituents. They affect the chemical shifts of the P atoms most likely through “cross-ring through space” interactions of the lone pairs on P atoms and the respective group R.⁴⁵ For RP_5Cl^+ -cages featuring alkyl-substituents R ($32a-e^+$) the resonances of the P atoms adjacent to the phosphonium moiety (marked in blue, Fig. 8) are shifted stepwise to lower field with a decreasing positive inductive effect of the substituent (from 44 ppm ($32a^+$) to 81 ppm ($32e^+$)). This is in agreement with the increased shielding of a P atom caused by additional alkyl-moieties in the γ -position relative to the P nuclei. This trend was previously termed γ -effect.⁴⁶ In contrast, the chemical shifts of tetra-coordinated P atoms (marked in red, Fig. 8) exhibit an almost inverse trend (from 99 ppm ($32a^+$) to 69 ppm ($32e^+$)). This high-field shift correlates with an increasing number of hydrogen atoms at the α -carbon atom of the substituent. This constitutes a characteristic feature of phosphonium moieties and was termed α -effect.⁴⁷ Overall, these influences are reflected in a change of the spin system between $32e-h^+$ featuring aryl- and methyl-substituents (ABMX₂ spin system) and those bearing alkyl-substituents $32a-d^+$ (ABM₂X spin system).

Employing dichlorophosphanes R_2NPCL_2 (R = Cy, i-Pr) in combination with $GaCl_3$ in reactions with P_4 gave distinct results. In mixtures of R_2NPCL_2 (R = Cy, i-Pr) and $GaCl_3$ the corresponding phosphonium ions $33a,b^+$ are the only observable species.^{20a} Indicative of their formation is a resonance in the ^{31}P NMR which is shifted to remarkable low field.¹⁸ It is highly influenced by the nature of the respective anion (compare $33a[GaCl_4]$: $\delta = 310$ ppm, $33a[Ga_2Cl_7]$: $\delta = 350$ ppm). The $GaCl_4^-$ salt of $33a^+$ can be isolated and constitutes a rare example of a structurally characterized mono-amino substituted phosphonium ion (Scheme 9). Upon reacting phosphonium ions $33a,b^+$ with P_4 insertion into a P–P bond is observed giving the C_5 -symmetric RP_5Cl^+ -cage cations $34a,b^+$. However, these cages are in equilibrium with the respective free phosphonium ions and P_4 which hampers the isolation of pure compounds $34a,b[GaCl_4]$. The observation of an equilibrium can be attributed to the relative stability of free $33a,b^+$. A similar reversibility of the phosphonium ion insertion was observed in the case of RP_5Cl^+ compounds. The addition of coordinating solvents like acetonitrile to solutions of $32[ECu_4]$ (E = Ga, Al) decomposes the respective metallate anion *via* chloride liberation. Nucleophilic attack of free chloride anions on 32^+ yields mainly the starting materials P_4 and $RPCL_2$ (R = alkyl, aryl) in a back reaction.

It is interesting to note that a reaction between the two-fold amino-substituted phosphonium ion $[(i-Pr_2N)_2P]^+$ (35^+) and P_4 was not observed.^{20a} This is attributed to a significantly lowered electrophilicity of 35^+ compared to $33a,b^+$.¹⁹ Also, diamino-phosphonium ions of type 35^+ reveal frontier orbitals comparable to those of allyl-anions⁴⁸ with the HOMO mainly located at the N atoms, and, thus, are not ambiphilic at the P moiety.

$R_2P_5[GaCl_4]$ cage compounds $36[GaCl_4]$ featuring two alkyl- or aryl-substituents R are obtained in high yield *via* the reaction of chlorophosphanes R_2PCL , $GaCl_3$ and P_4 (Scheme 10).⁴⁹

The Lewis acid–base adduct 37 and phosphanylphosphonium ion 38^+ are commonly formed in mixtures of chlorophosphanes and $GaCl_3$ in various stoichiometries.^{22b} Both convert into each other *via* equilibria involving free R_2PCL and $GaCl_3$.^{49,22b} Cations of type 38^+ serve as phosphonium ion sources in the presence of P_4 allowing for the formation of $R_2P_5^+$ -cage cations 36^+ . Most likely, this proceeds in analogy to quantum chemical calculations on the mechanism of the formation of MeP_5Cl^+ cage $32e^+$.³⁹ In contrast to dichlorophosphanes, however, the reaction conditions for the formation of $R_2P_5^+$ -cages $36a-h^+$ depend strongly on the substituent R. In the case of chlorophosphanes featuring aryl



Scheme 9 Reaction of R_2NPCL_2 (R = Cy, i-Pr) with $GaCl_3$ and P_4 and equilibrium of $34a,b^+$ with $33a,b^+$ and P_4 (middle) and molecular structure of $33a[GaCl_4]$ (left) and $34a^+$ (right).





Scheme 10 Preparation of compounds **36a–h**[GaCl₄] from P₄, R₂PCL and GaCl₃ in fluorobenzene (R = aryl) or according to a solvent free approach (R = alkyl) and species **37** and **38⁺** commonly observed in mixtures of R₂PCL and GaCl₃.

substituents R, the reactions proceeds smoothly at ambient temperature in fluorobenzene solution. A significant decrease in reaction time is observed with increasing steric bulk of the substituents (Dipp > Mes > C₆F₅ > Ph). For the preparation of R₂P₅⁺-cages **36a–d**⁺ featuring alkyl-substituents R, solvent-free conditions are necessary. Mixtures of R₂PCL (R = Cy, *i*-Pr, Et, Me) and GaCl₃ in a 1 : 1 stoichiometry form melts at ambient temperature.²⁸ Upon addition of P₄ to these melts, the formation of the corresponding cage compounds **36a–d**[GaCl₄] is observed. With increasing steric demand of the substituents R (Cy > *i*-Pr > Et > Me) extended reaction times and higher temperatures (100 °C to 150 °C) are required. The different reactivity of alkyl- and aryl-substituted phosphanes in the synthesis of R₂P₅-cage compounds of type **36**[GaCl₄] can be rationalized in terms of the different Lewis acidities of the corresponding phosphonium ions. The Lewis acidity is reflected *e.g.* by their distinct fluoride ion affinities (*e.g.* Me₂P⁺: FIA = 959 kJ mol⁻¹, Ph₂P⁺: FIA = 838 kJ mol⁻¹).^{19,50} This necessitates a more Lewis acidic environment for the transfer of a phosphonium ion featuring alkyl-groups, which is realized in a solvent free medium.

The molecular structures of all compounds of the series **36a–h**[GaCl₄] were determined by single crystal X-ray structure determination. This allowed for an in-depth evaluation of the influence of substituents of distinct steric demand on the structural parameters of the P₅-cage in the solid state (Fig. 10).



Fig. 10 Influence of the steric demand of substituents R on the structural parameters of the P₅⁺-cage core in cations of type **36⁺**; upon increasing the steric demand of R green arrows indicate increasing angles and distances and red arrows indicate declining angles and distances.

The phosphonium P atoms of cations of type **36⁺** show a distorted tetrahedral environment. If the steric demand of the substituent R is increased a stepwise increase in the corresponding C–P–C angle is observed from the sterically very bulky substituted Dipp₂P₅⁺ (**36h**⁺) to the methyl-substituted derivative **36e**⁺. This is accompanied by a decreasing P–P–P angle at the phosphonium moiety and stepwise increase in P–P bond lengths involving the phosphonium P atom.

As a consequence, the tetraphosphabicyclo[1.1.0]butane moieties display a more pronounced folding (distance between both P atoms adjacent to the phosphonium P atom decreases) and the P₅⁺-cages are stretched (distance between the bridgehead P–P bond and the phosphonium P atom increases).

The ³¹P NMR spectra of cage cations **36⁺** show A₂M₂X or A₂MX₂ spin systems in accordance with their C_{2v} symmetry and are comparable to those observed for the P₅X₂⁺ cages **26a–c**⁺ (Fig. 11). The observation of two different spin systems for R₂P₅⁺-cages of type **36⁺** may be explained in terms of different steric and electronic influences of the alkyl- or aryl-substituent R. In the series of alkyl-substituted R₂P₅⁺-cages (**36a**⁺ to **36d**⁺) the resonances of the phosphonium P atoms are shifted to higher field and the resonances of the adjacent P atoms are shifted to lower field. This can be explained in terms of a combination of *α*-effect and *γ*-effect (*vide infra*).^{46,47} The resonances of the tetra-coordinated P atoms in aryl-substituted cations **36e–h**⁺ are shifted to higher field compared to those of the corresponding P atoms in cages **36a–d**⁺. This is due to a positive mesomeric effect, namely the donation of *π*-electron density from the aryl substituents to the lobes of the anti-bonding *σ*^{*}(P–P) orbitals at the phosphonium moiety.^{47a} Some main group centered, predominantly electrophilic ambiphiles react with P₄ *via* multiple insertions into P–P bonds of the P₄ tetrahedron. This is exemplified by SiP₄-cage compound **40**,

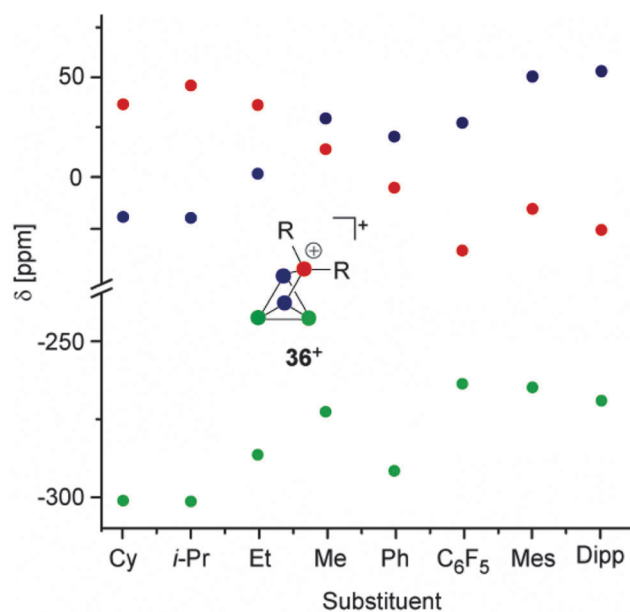
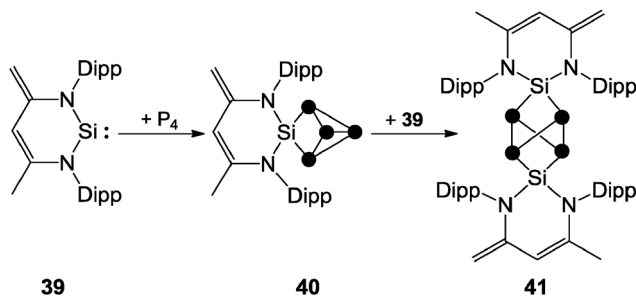

Fig. 11 Plot of the ³¹P NMR chemical shifts of R₂P₅⁺-cages **36a–h**⁺ versus their alkyl- or aryl-substituent.





Scheme 11 Stepwise insertion of zwitterionic silylene **39** into P–P bonds of P_4 yielding SiP_4 -cage compound **40** and Si_2P_4 -cage compound **41**.

which is obtained by the reaction of P_4 with zwitterionic silylene **39**. This compound reacts with a second equivalent of **39** to give the Si_2P_4 -cage compound **41** (Scheme 11).¹⁴ The second insertion takes place at a P–P bond opposing the initially inserted main group element. The related product **4** was obtained by the reaction of P_4 with a low valent Al(i) species (Fig. 2).¹³

Distinct results were obtained in the investigation of multiple insertions of phosphonium ions into P–P bonds of P_4 . In this context, solvent-free mixtures of P_4 , $\text{Ph}_2\text{P}^+\text{Cl}$ and GaCl_3 in various stoichiometries and at different temperatures were investigated. A 1 : 1 : 1 mixture yields quantitatively the Ph_2P_5^+ -cage compound **36f** $[\text{GaCl}_4]$ after 45 min at 60 °C (Scheme 12).⁵¹

The $\text{Ph}_4\text{P}_6^{2+}$ -cage cation **42**²⁺ is observed in a mixture of 1 : 8 : 5 stoichiometry (P_4 : $\text{Ph}_2\text{P}^+\text{Cl}$: GaCl_3) as the main product after a reaction time of seven hours at 70 °C. The ³¹P NMR spectrum of **42**²⁺ shows a characteristic ABMM'XX' spin system which is in accordance with the insertion of a second Ph_2P^+ -phosphonium ion into a P–P bond adjacent to the phosphonium

moiety in **36f**⁺. Two second-order resonances corresponding to an AA'XX'X''X''' spin system are expected for the isomer of **42**²⁺ formed *via* formal insertion into two opposing P–P bonds of P_4 . Such a species is not formed in the melt reaction. The formation of dication **42**²⁺ can only be observed if the ratio of $\text{Ph}_2\text{P}^+\text{Cl}$ and GaCl_3 is higher than 0.5. In these mixtures, the dominant gallium species is GaCl_4^- ; hence, the melt can be considered as basic medium. In a more Lewis acidic melt, composed of P_4 , $\text{Ph}_2\text{P}^+\text{Cl}$ and GaCl_3 in a 1 : 3 : 6 stoichiometry, the tricationic $\text{Ph}_6\text{P}_7^{3+}$ -cage **43**³⁺ is formed exclusively. Large single crystals of **43**³⁺ as a heptachlorodigallate salt are formed in the respective melt after 12 h at 100 °C. Cation **43**³⁺ features a nortricyclane-type (tricyclo[2.2.1.0^{2,6}]heptane) framework. It is composed of a basal ring of three-coordinated P atoms, three tetra-coordinated P atoms at the bridging positions and a three-coordinated P atom at the apex of the cage. This skeleton is reminiscent of the trianionic phosphide P_7^{3-} ,⁵² several polyphosphanes $\text{R}_3\text{P}_7^{53}$ and many polyphosphorus-chalcogenides like *e.g.* P_4S_3 .⁵⁴ The ³¹P NMR spectrum of **43**³⁺ shows an AA'A''BXX'X'' spin system resulting from the C_3 symmetry of the cage. A ²J or ³J P–P bond coupling to the apex of the cage is not observed which might be a result of the adjacent phosphonium P atoms. This leads to a first-order quartet resonance for the apical P atom. The highly electrophilic cation **43**³⁺ is stable only in the presence of excess GaCl_3 . This prevents the detrimental presence of chloride anions which decompose **43**³⁺ by nucleophilic attack and subsequent degradation *via* **42**²⁺ to **36f**⁺. This illustrates that the consecutive insertion of up to three Ph_2P^+ -moieties into P–P bonds of P_4 is directed by the Lewis acidity of the reaction mixture.

7. Cationic polyphosphorus cages featuring four-membered heterocycles

Cyclic diaminohalophosphanes are important precursors for the preparation of cyclic phosphonium ions *via* halide abstraction.⁵⁵ Within this class of compounds, phosphazanes, like the diphosphadiazane **44**, are of particular interest (Scheme 13). These compounds feature two chloro-substituted P moieties and, thus, offer a versatile reactivity.⁵⁶ The diphosphadiazanium ion **45**⁺ is generated from **44** upon chloride abstraction with GaCl_3 . Solutions of **45**⁺ are characterized by a bright red colour and the ³¹P NMR spectrum shows a broad resonance at characteristic low field ($\delta = 242.3$ ppm) indicating the formation of a di-coordinated P moiety. Subsequent addition of P_4 to this solution leads to discolouration and quantitative formation of the P_5^+ -cage compound **46** $[\text{GaCl}_4]$.⁵⁷ The molecular structure of cation **46**⁺ shows a planar four-membered (NP)₂ ring and an almost orthogonal oriented P–Cl bond (Scheme 13). This arrangement is also reflected by the A₂MXZ spin system observed in the ³¹P NMR spectrum of C_5 -symmetric cation **46**⁺. Interestingly, the P_5^+ -cage does not couple with the chloro-substituted P atom resulting in the observation of a singlet resonance for the latter. This P–Cl functionality was used for the *in situ* generation of a phosphonium ion upon addition of three equivalents of GaCl_3 to the reaction mixture. The resulting dicationic intermediate

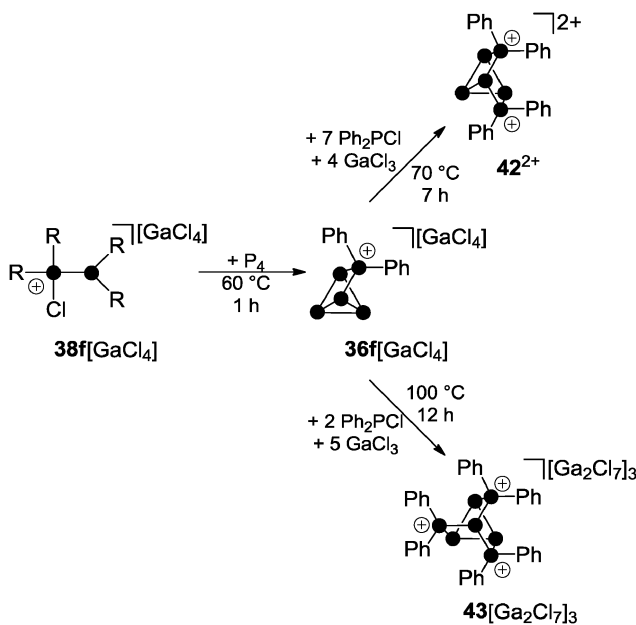

Scheme 12 Stepwise insertion of Ph_2P^+ -phosphonium ions into P–P bonds of P_4 yielding $\text{Ph}_4\text{P}_6^{2+}$ -cage cation **42**²⁺ and $\text{Ph}_3\text{P}_7^{3+}$ -cage compound **43** $[\text{Ga}_2\text{Cl}_7]_3$.





Scheme 13 Stepwise synthesis of N_2P_{10} -cage compound **47** via insertion of phosphonium ions generated *in situ* by the reaction of diphosphadiazane **44** with $GaCl_3$.

was not detected. However, upon addition of P_4 , the formation of the corresponding insertion product 47^{2+} is observed. The ^{31}P NMR spectrum of 47^{2+} shows an A_2MX_2 spin system which is consistent with two C_{2v} -symmetric P_5^+ -cages bridged by two imido-groups. The dication can be isolated as heptachloro-gallate salt $47[Ga_2Cl_7]_2$ and the molecular structure of the N_2P_{10} -cage was confirmed by single crystal structure determination (Scheme 13). This illustrates that the stepwise insertion of the disguised bifunctional Lewis acid $[DippNP]_2^{2+}$ into P–P bonds of two P_4 tetrahedra can be mediated by the Lewis acidity of the reaction mixture. The utilization of an excess of $GaCl_3$ allows for the preparation of the more electrophilic,

higher charged species 47^{2+} , similar to the reaction sequence yielding 43^{3+} (Scheme 12).

It is interesting to note that related NHC analogues, five-membered 1,3,2-diazaphospholenium ions, do not react with P_4 under various reaction conditions⁵⁸ similar to acyclic, diamino-phosphonium ion ($i\text{-Pr}_2N)_2P^+$ (*vide infra*). This indicates that the strained four-membered ring geometry present in diphosphadiazanium ions is crucial for its reactivity towards P_4 .

Other cyclic, four-membered phosphorus containing heterocycles can be employed in reactions with P_4 as well.⁵⁹ The cyclic chlorophosphane **48**, featuring a $SiCl_2$ -backbone,⁶⁰ reacts with $GaCl_3$ to give the corresponding Lewis acid–base adduct **49** (Scheme 14).



Scheme 14 Preparation of P_5^+ -cage cation **51** from P_4 , $GaCl_3$ and chlorophosphane **48** (top) and preparation of zwitterionic P_5 -cage compound **53** from P_4 and zwitterionic phosphonium ion **52**.



The formation of related phosphonium ion 50^+ is observed only upon addition of a second equivalent of GaCl_3 . This can be explained by the suppression of detrimental concentrations of nucleophilic chloride anions through the formation of Ga_2Cl_7^- .

Cation 50^+ is not stable in solution and decomposes *via* Lewis acid mediated Me_3SiCl elimination. However, the insertion reaction with P_4 requires only the use of one equivalent of GaCl_3 . In 1 : 1 : 1 mixtures of **48**, GaCl_3 and P_4 the corresponding P_5^+ -cage compound **51** $[\text{GaCl}_4]$ is formed slowly within four days presumably due to the presence of small amounts of 50^+ formed from **49** in a series of equilibrium reactions.⁵⁹ The related zwitterionic phosphonium ion **52** features a formally anionic AlCl_2 -backbone.⁶⁰ It reacts with P_4 in toluene giving the formally neutral P_5 -cage compound **53**. A conversion of only 30% to the respective product is observed in the reaction mixture, presumably due to the low electrophilicity of **52**. However, the developed synthetic protocol includes removal of unreacted starting materials **52** and P_4 by sublimation which can be used in additional synthetic cycles increasing the overall isolated yield.

8. Cationic polyphosphorus-chalcogen cages

A multitude of phosphorus-chalcogenides have been characterized to date and many of their structural motifs are displayed even in undergraduate textbooks.⁶¹ However, until recently, only very few examples of polyphosphorus-chalcogen cations were known which was due to the lack of established synthetic routes for their preparation. To the best of our knowledge only three distinct protocols have been reported so far. The first is based on the reaction of P_4S_3 with *in situ* generated phosphonium ion PI_2^+ (Scheme 15).^{44b}

The phosphonium ion formally inserts into a P–P bond of the basal P_3 -ring accompanied by migration of one of the iodo-substituents to an adjacent P atom giving cation **54** $^+$. However, **54** $^+$ is not stable and subsequently disproportionates *via* an unknown reaction pathway to form **55** $^+$ and **56** $^+$. This process involves the extrusion of a very reactive iodo-phosphinidene $[\text{PI}]$ and redistribution of the sulfur atoms.

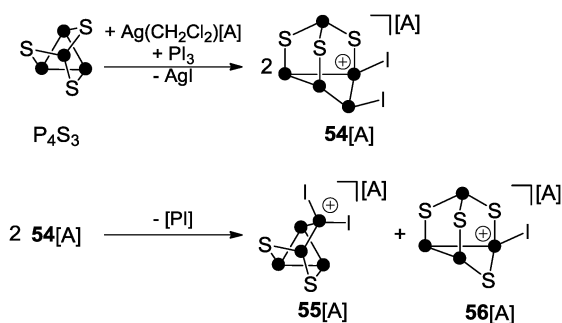

Scheme 15 Reaction of P_4S_3 with *in situ* generated phosphonium ion PI_2^+ ; $\text{A} = \text{Al}(\text{OC}(\text{CF}_3)_3)_4$.

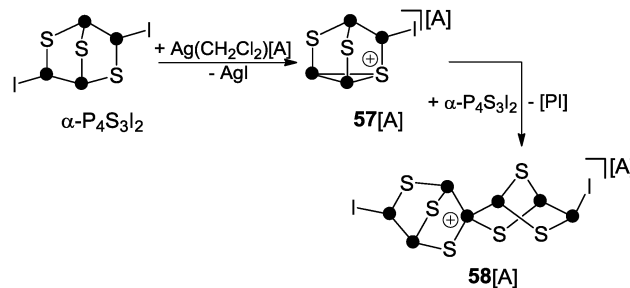

Scheme 16 Reaction of $\alpha\text{-P}_4\text{S}_3\text{I}_2$ with $\text{Ag}(\text{CH}_2\text{Cl}_2)[\text{A}]$, $\text{A} = \text{Al}(\text{OC}(\text{CF}_3)_3)_4$.

The second protocol is based on halide abstraction from $\alpha\text{-P}_4\text{S}_3\text{I}_2$ with $\text{Ag}(\text{CH}_2\text{Cl}_2)[\text{Al}(\text{OC}(\text{CF}_3)_3)_4]$ and yields the spiro-cyclic cage cation **58** $^+$ (Scheme 16).⁶² The initial step involves the formation of **57** $^+$ *via* iodide abstraction from $\alpha\text{-P}_4\text{S}_3\text{I}_2$. Cation **57** $^+$ subsequently reacts with a second equivalent of $\alpha\text{-P}_4\text{S}_3\text{I}_2$ and this in association with the formal extrusion of phosphinidene $[\text{PI}]$ gives rise to spiro-cyclic cage **58** $^+$. However, detailed information on the mechanism of the formation of **58** $^+$ was not gained. The structural motif of this cation is unprecedented and contains the first tetra-coordinated P atom exclusively bonded to P and S atoms.⁶²

Recently, a third approach garnered interest which is based on using cationic polyphosphorus cages as starting materials for the preparation of cationic polyphosphorus-chalcogen cages. They constitute potentially versatile reagents due to the multitude of distinctly substituted derivatives which are all conveniently obtained in one step procedures from white phosphorus.⁴⁹ Chalcogenation reactions of R_2P_5^+ -cage compounds **36a** $[\text{GaCl}_4]$ and **36f** $[\text{GaCl}_4]$ with elemental grey selenium yield the corresponding polyphosphorus-selenium cages **59a** $[\text{GaCl}_4]$ and **59f** $[\text{GaCl}_4]$ (Scheme 17). Both are obtained at elevated temperatures (110–150 °C) following a solvent-free protocol. In some cases,

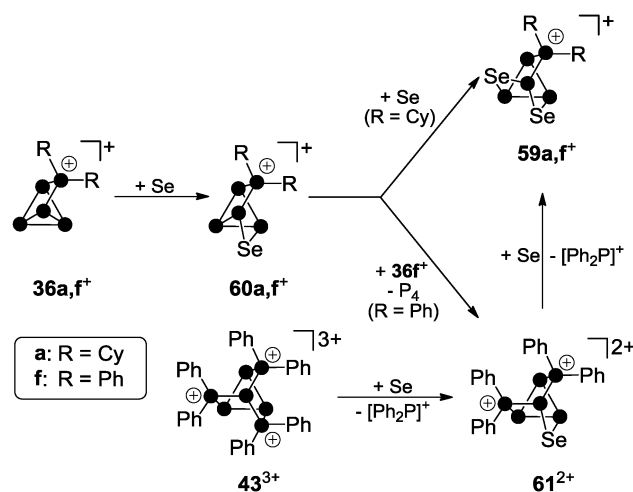

Scheme 17 Stepwise insertion of selenium atoms into P–P bonds of **36a,f** $^+$ and stepwise substitution of $[\text{Ph}_2\text{P}]^+$ -moieties in **43** $^{3+}$ by selenium atoms giving the nortricyclane-type polyphosphorus-chalcogen cage cations **59a,f** $^+$ and **61** $^{2+}$.



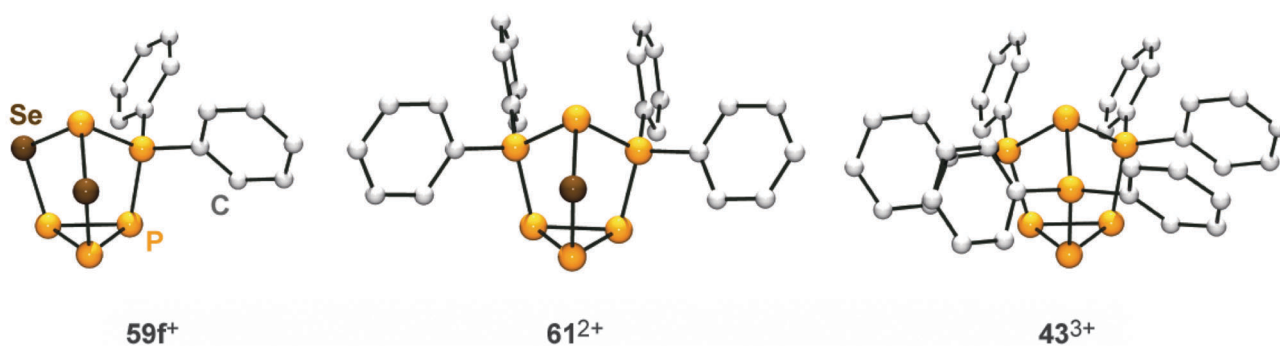

Fig. 12 Nortricyclane type molecular structures of the related, polyphosphorus cations **59f⁺**, **61²⁺** and **43³⁺**.

the addition of one equivalent of GaCl₃ is beneficial since it lowers the melting point of the respective melt. Both cations are formed upon insertion of two selenium atoms into two P–P bonds adjacent to the phosphonium moieties in **36a,f⁺**.

Their structural motif resembles that of nortricyclane, with a basal P₃-ring, the tetra-coordinated P atom and the selenium atoms occupying the bridging positions, and one P atom defining the apex of the cage. This class of compounds feature interesting ³¹P and ⁷⁷Se NMR characteristics. Cages **59a,f⁺** reveal an AM₂OX spin system for the C₅-symmetric isotopomer without a ⁷⁷Se nucleus. These resonances are superimposed by the C₁-symmetric isotopomer featuring one ⁷⁷Se atom in one of the bridging positions. This isotopomer gives rise to an AMNOXZ spin system which is highly influenced by higher order effects. However, in the case of **59a⁺**, the spin systems of both isotopomers were successfully simulated allowing for the exact determination of chemical shifts and coupling constants. A series of experiments employing varying temperatures, reaction times and stoichiometries gave meaningful insights into the mechanism of the chalcogenation. These experiments indicate that the insertion of Se atoms into P–P bonds of **36a,f⁺** proceeds in a stepwise manner *via* the intermediates **60a,f⁺**. In the case of alkyl-substituted cage **36a⁺** the insertion of a second equivalent grey selenium is fast, yielding the respective product **59a⁺** quantitatively. If the aryl-substituted starting material **36f⁺** is employed, the intermediate formation of dication **61²⁺** is observed. This species forms *via* the transfer of a [Ph₂P]⁺ moiety from a second equivalent of **36f⁺** to the reactive intermediate **60f⁺**. Due to the higher stability of the corresponding phosphonium ion Ph₂P⁺,^{19,50} this transfer is faster than the insertion of the second selenium atom. Subsequently, one of the [Ph₂P]⁺-moieties of **61²⁺** is substituted by a selenium atom giving rise to **59f⁺**. The formally liberated Ph₂P⁺-phosphonium ion is not stable and reacts with a GaCl₄[−] anion to give the Lewis acid–base adduct **37** (Ph₂PCl–GaCl₃). This is in accordance with the observation of only 50% conversion and the quantitative formation of P₄ and **37** or the respective oxidation product Ph₂P(Se)Cl–GaCl₃ in the case of reactions involving **36f⁺** as a starting material. The targeted preparation of **61²⁺** as GaCl₄[−] salt is achieved by utilizing a 2 : 1 stoichiometry of **36f⁺** and grey selenium. Another synthetic approach for the preparation of **61²⁺** is the targeted substitution of one [Ph₂P]⁺-moiety in

the tricationic cage **43³⁺**. This is achieved by reacting **43³⁺** with grey selenium under solvent-free conditions (Scheme 17).⁴⁹ Dication **61²⁺** was comprehensively characterized by X-ray crystallography (Fig. 12) as well as ³¹P and ⁷⁷Se NMR spectroscopy. The ³¹P NMR spectrum reveals a characteristic AA'MOXX'-spin system for the isotopomer without a ⁷⁷Se nucleus which is superimposed by the respective AA'MOXX'Z-spin system of the ⁷⁷Se containing species.

A similar reactivity was observed for reactions of the P₅⁺-cage **36a⁺** or the P₇³⁺-cage **43³⁺** with elemental α-S₈.⁴⁹ The polyphosphorus cation **43³⁺** and cationic polyphosphorus-chalcogen cages **61²⁺** and **59f⁺** are formally derived from the stepwise isolobal exchange of [Se] atoms by [Ph₂P]⁺ units in the bridging positions of the nortricyclane-type structure of P₄Se₃. This allows for an in-depth study of the ³¹P NMR characteristics of the whole series of compounds and a correlation with the observed structural features in the solid state. Fig. 13 shows the dependence of the chemical shifts of **43³⁺**, **61²⁺** and **59f⁺**, the related sulfur-containing cages **62a⁺** and **63²⁺**, and P₄Ch₃ (Ch = Se, S)⁶³ on the number of chalcogen atoms in the corresponding molecules. The stepwise exchange of tetra-coordinated P atoms in **43³⁺** by Se or S atoms is accompanied by a high-field shift of the resonances of the P atoms of the basal three-membered ring. The chemical shifts of basal P atoms in nortricyclane-type cages are influenced by the exocyclic angles of the P₃-ring.⁶³ The observed high-field shift correlates well with decreasing exocyclic angles observed in the solid state structures of the respective compounds. The resonances of apical P atoms exhibit the widest range of chemical shifts and reveal a stepwise down-field shift upon the substitution of tetra-coordinated P atoms by chalcogen atoms. This is consistent with different electronegativities of directly bonded phosphorus or chalcogen atoms. Moreover, apical P atoms show a high dependency of their chemical shift on elongation or compression of the nortricyclane framework.⁶⁴ Elongation is accompanied by a decrease in the P–P–P angles involving the apical P atom. This increases the s-orbital contribution to the lone pair of electrons and leads to an upfield shift of the corresponding resonance in the ³¹P NMR spectrum.⁶⁵ On this basis, the observed downfield shift indicates a stepwise elongation of the cages which is observed in the respective molecular structures in the solid state.



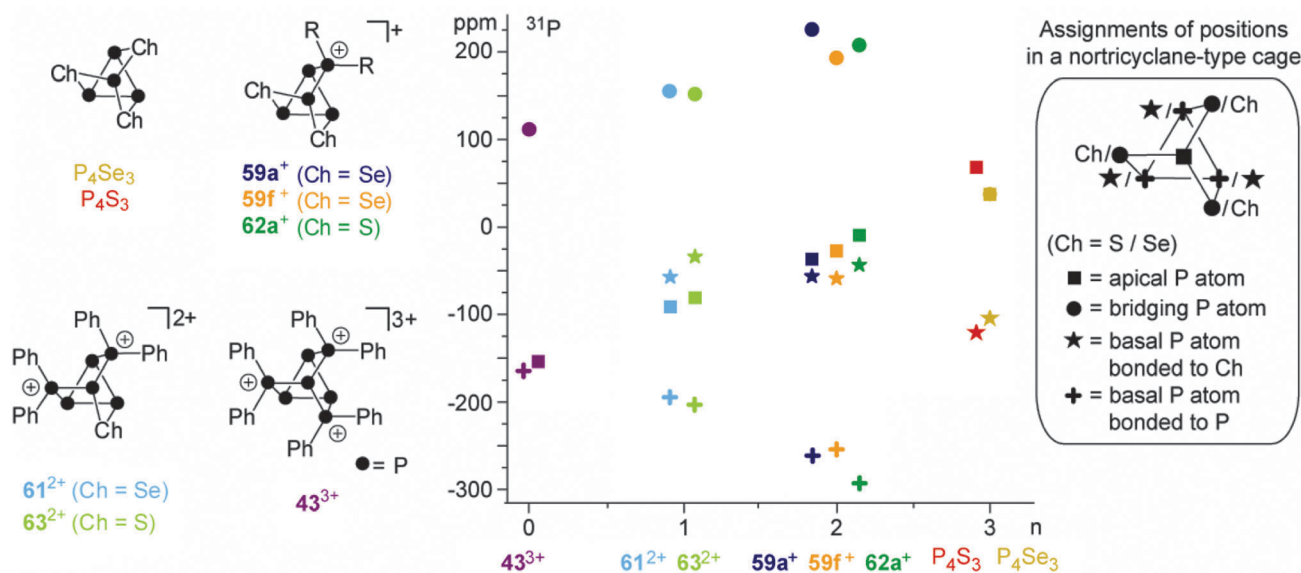

Fig. 13 Family of cationic polyphosphorus-chalcogen cages formally derived from stepwise isolobal exchange of [Ch] by $[R_2P]^+$ units in P_4Ch_3 (Ch = Se, S, left), their ^{31}P NMR shifts versus the number of chalcogen atoms (n , middle) and the assignment of P or Ch atoms to the positions of a nortricyclane-type cage (right).

9. Nucleophilic fragmentation of cationic polyphosphorus cages

The activation of white phosphorus with carbenes, which belong to the class of predominantly nucleophilic ambiphiles, displays one of the most diverse fields of P_4 chemistry.⁶ The *cyclo*-triphosphirene derivative **C** constitutes a key intermediate in all transformations, independent of the characteristic of the respective carbene employed (Fig. 1). However, intermediate **C** is elusive and distinct reaction pathways occur depending on the electronic and steric features of carbene **L** (Scheme 18). Bertrand and co-workers reacted P_4 with carbenes L^1 and L^3 in a 1:2 stoichiometry and obtained *E/Z* isomers **64a,b** via an intermediate of type **C**.¹² Bicyclic species **65** is the result of a cyclo-addition reaction involving the phosphorus double bond of an intermediate of type **C** and the alkyl amino carbene L^4 .⁶⁶ Compound **66** results from a ring-opening reaction of an intermediate **C** with two equivalents of L^5 .⁶⁶ This reaction is accompanied by the formation of **67** as a side product. This P_2 -species is formed by the formal [2+2] fragmentation of P_4 by carbene L^5 . A [3+1]-fragmentation of the P_4 tetrahedron was achieved using the sterically less demanding carbene L^6 in a reaction with P_4 in a 3:1 stoichiometry.⁶⁶ The P_1 -fragment was identified as **68**⁺ and isolated as chloride salt. The presence of chloride anions is explained by the decomposition of $CHCl_3$ solvent molecules.

A compound of unknown constitution featuring a P_3 moiety was indicated in the ^{31}P NMR spectrum of the respective reaction mixture.⁶⁶

A combination of phosphonium ion and carbene mediated P_4 activation constitutes a novel, potentially versatile approach for the preparation of cationic polyphosphorus cages. This strategy allows for the preparation of polyphosphorus cations

featuring imidazoliumyl-substituents. These substituents are valuable for two purposes. First, they serve well for the stabilization of cations by delocalization of the positive charge.⁷⁰ Second, they stabilize low-coordinated P moieties by reducing the nucleophilicity of directly bonded P atoms.⁷¹ The reaction of P_5^+ -cage compound **32h**[GaCl₄] with carbene L^7 in a 1:1 stoichiometry yields the bicyclo[1.1.0]tetraphosphane **69**[GaCl₄] (Scheme 19).⁶⁷ The bicyclic framework is substituted with an imidazoliumyl-group in an *exo*-position and a phosphanyl-group in an *endo*-position. This is reminiscent of the intermediate **31** observed in the formation of RP_5Cl^+ -cages. Cation **69**⁺ features an ACEMX spin system indicating a non-symmetrical molecular structure due to hindered rotation around the P–P bond involving the Dipp-substituted P atom. The *endo,exo*-substitution of **69**⁺ causes a short intermolecular distance between the Dipp- and the imidazoliumyl-substituted P atoms in the solid state (see molecular structure in Scheme 19). This spatial proximity is also indicated in solution by an extraordinarily large $^3J(PP)$ coupling constant of 244.6 Hz in the ^{31}P NMR spectrum.

The reaction of **32h**[GaCl₄] with carbene L^7 in a 1:3 stoichiometry proceeds via a quantitative [3+2]-fragmentation of the P_5^+ -cage (Scheme 20).⁶⁷

The P_2 fragment was identified as the neutral P_2 species **70** featuring an inversely-polarized⁶⁸ phosphalkene moiety. The di-coordinated P atom bears a phosphanyl-substituent which originates from the tetra-coordinated P atom of starting material **32h**⁺. The P_3 fragment was identified as GaCl₄[−] salt of cation **71**⁺ which features a chain of three di-coordinated P atoms terminated by two imidazoliumyl-substituents. This compound is characterized by a deep green colour that results from $n \rightarrow \pi^*$ and $\pi \rightarrow \pi^*$ transitions similar to those observed in diphosphenes.⁶⁹ Quantum chemical calculations elucidated the bonding in **71**⁺.⁶⁷ The frontier orbital arrangement of the cation is closely related

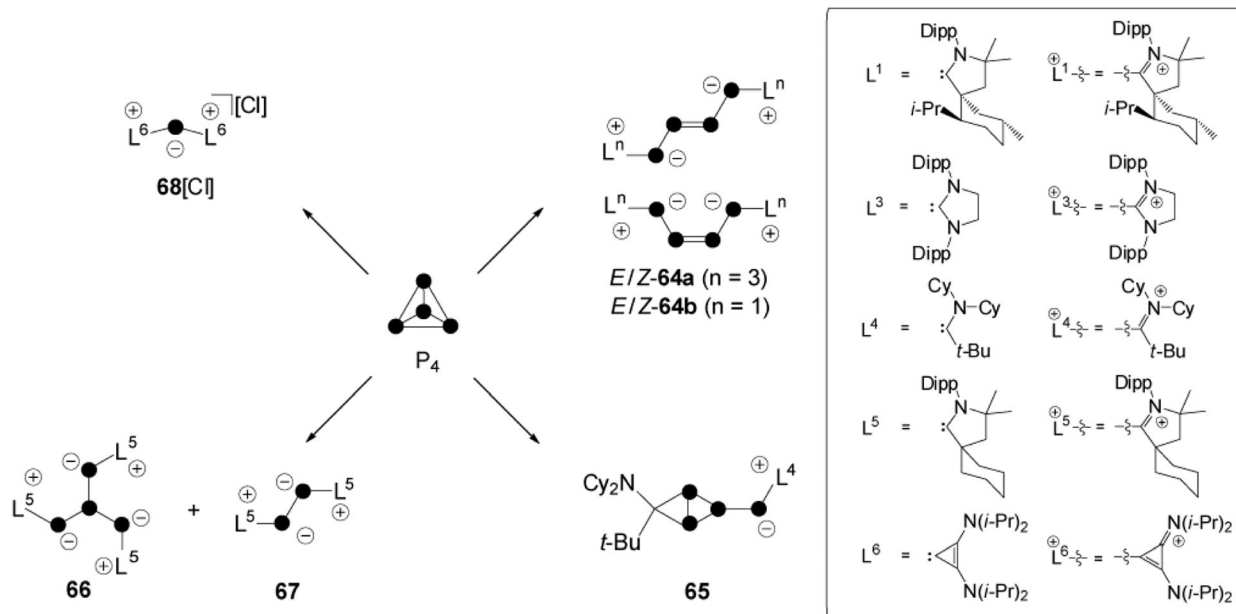
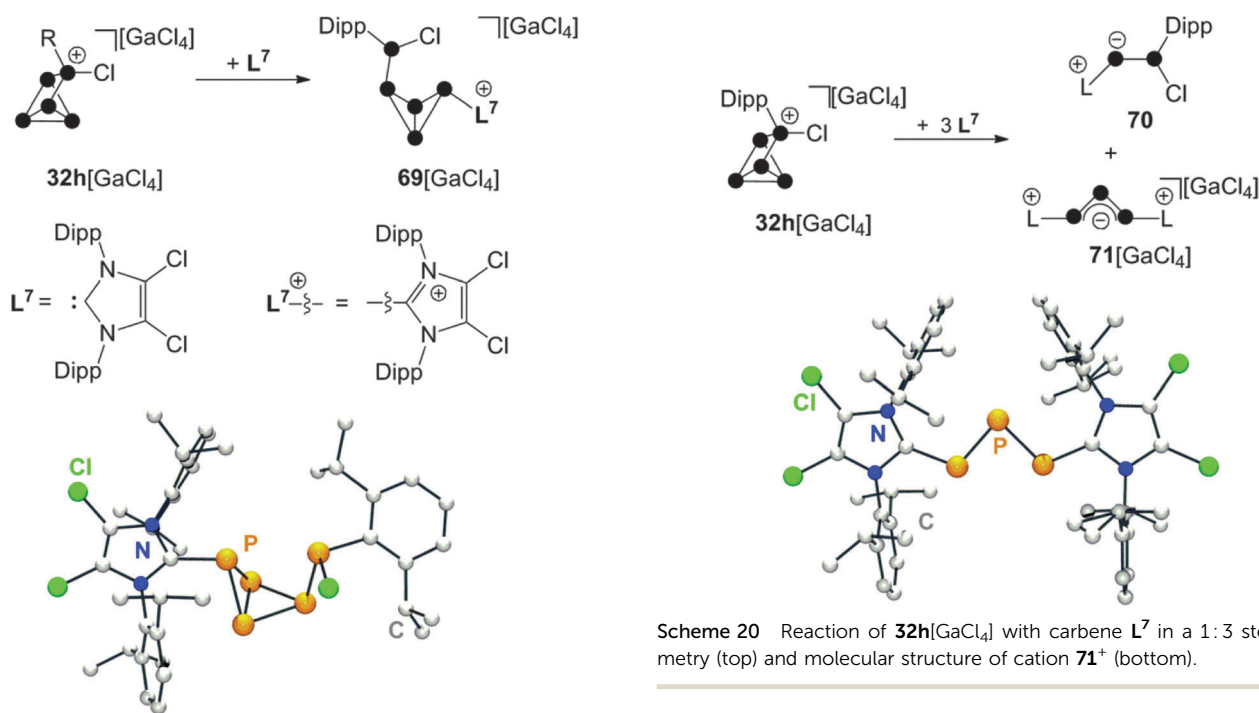

Scheme 18 Carbene-induced transformation and fragmentation reactions of P_4 .Scheme 19 Reaction of $32h[GaCl_4]$ with carbene L^7 in a 1:1 stoichiometry (top) and molecular structure of cation 69^+ (bottom).Scheme 20 Reaction of $32h[GaCl_4]$ with carbene L^7 in a 1:3 stoichiometry (top) and molecular structure of cation 71^+ (bottom).

to the classical π -system of the C_3 -allyl anion. Thus, 71^+ features a local triphosphaallylanion moiety substituted with imidazoliumyl-groups. The mechanism of the [3+2] fragmentation is explained by the reaction sequence in Scheme 21 on the basis of experimental evidence and quantum chemical calculations.⁶⁷ The reaction of $32h^+$ with the first equivalent of L^7 yields the experimentally verified species 69^+ . The nucleophilic attack of

L^7 occurs at a P atom adjacent to the phosphonium moiety in $32h^+$ and initiates a P–P bond cleavage. This reaction step is the reverse of the last step in the formation of RP_5Cl^+ -cages (Fig. 7) and is in accordance with the observed reversibility of phosphonium ion insertion into P–P bonds of P_4 (*vide infra*). The nucleophilic attack of a second carbene L^7 occurs at the *endo*-substituted P atom of 69^+ and initiates a P–P bond cleavage in the respective P_3 -ring.

This yields intermediate 72^+ according to quantum chemical calculations.⁶⁷ Subsequently, this intermediate intramolecularly



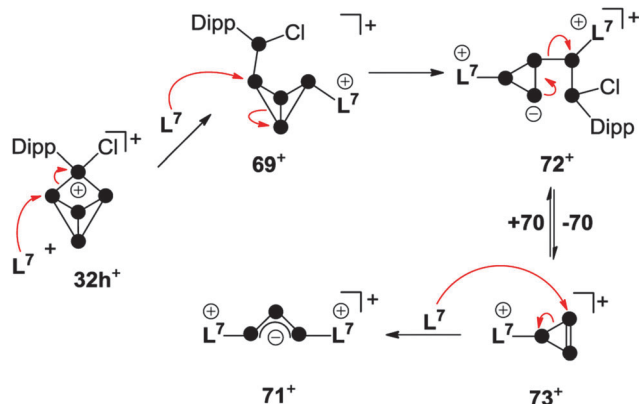

Scheme 21 Reaction sequence for the carbene-induced [3+2]-fragmentation of P_5^+ -cage $32h^+$.

eliminates the P_2 fragment 70 . This yields the elusive triphosphirene derivative 73^+ which is related to the key intermediate C (Fig. 1) of carbene-induced P_4 activation.^{12,66} The nucleophilic attack of a third carbene L^7 on the PP double bond of 73^+ initiates a ring-opening and yields the second fragment 71^+ . The ease of fragmentation (high yields, multi-gram scale) together with the facile accessibility of cationic phosphorus cages from P_4 and the multitude of carbenes available render this approach suitable for the preparation of a plethora of interesting poly-phosphorus compounds.

Abbreviations

aAAC	Acyclic alkyl amino carbene
Ab	Ambiphile
Ch	Chalcogen atom (Se or S)
El	Electrophile
Et	Ethyl
cAAC	Cyclic alkyl amino carbene
Cy	Cyclo-hexyl
Dipp	2,6-Di-iso-propylphenyl
FIA	Fluoride ion affinity
HOMO	Highest occupied molecular orbital
i-Pr	Iso-propyl
LUMO	Lowest unoccupied molecular orbital
Me	Methyl
Mes*	2,4,6-Tri- <i>tert</i> -butylphenyl
NHC	N-Heterocyclic carbene
Nu	Nucleophile
OTf	Triflate, trifluoromethylsulfonate
<i>t</i> -Bu	<i>tert</i> -Butyl

Acknowledgements

This work was supported by the Fonds der Chemischen Industrie (FCI, scholarship for M.H.H.), the German Science Foundation (DFG, WE 4621/2-1), and the ERC (SynPhos 307616).

References

- 1 C. A. Dyker and N. Burford, *Chem. – Asian. J.*, 2008, **3**, 28.
- 2 M. Donath, E. Conrad, P. Jerabek, G. Frenking, R. Fröhlich, N. Burford and J. J. Weigand, *Angew. Chem., Int. Ed.*, 2012, **51**, 2964.
- 3 K.-O. Feldmann and J. J. Weigand, *Angew. Chem., Int. Ed.*, 2012, **51**, 7545.
- 4 D. E. Corbridge, *C Phosphorus – an Outline of its Chemistry and Technology*, Elsevier, Amsterdam, 5th edn, 1995.
- 5 (a) B. M. Cossairt, N. A. Piro and C. C. Cummins, *Chem. Rev.*, 2010, **110**, 4164; (b) M. Caporali, L. Gonsalvi, A. Rossin and M. Peruzzini, *Chem. Rev.*, 2010, **110**, 4235.
- 6 (a) M. Scheer, G. Balazs and A. Seitz, *Chem. Rev.*, 2010, **110**, 4236; (b) N. A. Giffin and J. D. Masuda, *Coord. Chem. Rev.*, 2011, **255**, 1342; (c) S. Khan, S. S. Sen and H. W. Roesky, *Chem. Commun.*, 2012, **48**, 2169.
- 7 (a) W. W. Schoeller, *Phys. Chem. Chem. Phys.*, 2009, **11**, 5273; (b) W. W. Schoeller, V. Staemmler, P. Rademacher and E. Niecke, *Inorg. Chem.*, 1986, **25**, 4382; (c) R. O. Jones and D. Hohl, *J. Chem. Phys.*, 1990, **11**, 6710; (d) V. G. Tsierelson, N. P. Tarasova, M. F. Bobrov and Y. V. Smetannikov, *Heteroat. Chem.*, 2006, **17**, 572; (e) C. R. C. R. Brundle, N. A. Kuebler, M. B. Robin and H. Basch, *Inorg. Chem.*, 1972, **11**, 20; (f) S. S. Evans, P. J. Joachim, A. F. Orchard and D. W. Turner, *Int. J. Mass Spectrom. Ion Phys.*, 1972, **9**, 41; (g) R. R. Hart, M. B. Robin and N. A. Kuebler, *J. Chem. Phys.*, 1965, **42**, 3631; (h) M. Driess and H. Nöth, *Molecular Clusters of the Main Group Elements*, Wiley-VCH, Weinheim, 1st edn, 2004; (i) I. Krossing, *Homoatomic Cages and Clusters of the Heavier Group 15 Elements: Neutral Species and Cations*, 2004, pp. 209–229.
- 8 (a) R. Riedel, H.-D. Hausen and E. Fluck, *Angew. Chem., Int. Ed. Engl.*, 1985, **24**, 1056; (b) E. Fluck, R. Riedel, H.-D. Hausen and G. Heckmann, *Z. Anorg. Allg. Chem.*, 1987, **46**, 7052.
- 9 E. Fluck, C. M. E. Pavlidou and R. Janoscheck, *Phosphorus Sulfur Relat. Elem.*, 1979, **6**, 469.
- 10 M. B. Power and A. R. Barron, *Angew. Chem., Int. Ed. Engl.*, 1991, **30**, 1353.
- 11 H. M. Tuononen, R. Roesler, J. L. Dutton and P. J. Ragogna, *Inorg. Chem.*, 2007, **46**, 10693.
- 12 (a) J. D. Masuda, W. W. Schoeller, B. Donnadiou and G. Bertrand, *Angew. Chem., Int. Ed.*, 2007, **46**, 7052; (b) J. D. Masuda, W. W. Schoeller, B. Donnadiou and G. Bertrand, *J. Am. Chem. Soc.*, 2007, **129**, 14180.
- 13 (a) Y. Peng, H. Fan, H. Zhu, H. W. Roesky, J. Magull and C. E. Hughes, *Angew. Chem., Int. Ed.*, 2004, **43**, 3443; (b) G. Prabusankar, A. Doddi, C. Gemel, M. Winter and R. A. Fischer, *Inorg. Chem.*, 2010, **49**, 7976; (c) W. Uhl and M. Benter, *Chem. Commun.*, 1999, 771; (d) C. Dohmeier, H. Schnöckel, C. Robl, U. Schneider and R. Ahlrichs, *Angew. Chem., Int. Ed. Engl.*, 1994, **33**, 199.
- 14 (a) Y. Xiong, S. Yao, M. Brym and M. Driess, *Angew. Chem., Int. Ed.*, 2007, **46**, 4511; (b) S. S. Sen, S. Khan, H. W. Roesky, D. Kratzert, K. Meindl, J. Henn, D. Stalke, J.-P. Demers and



- A. Lange, *Angew. Chem., Int. Ed.*, 2011, **50**, 2322; (c) S. Khan, R. Michel, S. S. Sen, H.-W. Roesky and D. Stalke, *Angew. Chem., Int. Ed.*, 2011, **50**, 11786.
- 15 (a) M. Driess, A. D. Fanta, D. Powell and R. West, *Angew. Chem., Int. Ed. Engl.*, 1989, **28**, 1038; (b) A. D. Fanta, R. P. Tan, N. M. Comerlato, M. Driess, D. R. Powell and R. West, *Inorg. Chim. Acta*, 1992, **198**, 733.
- 16 M. Driess, *Angew. Chem., Int. Ed. Engl.*, 1991, **30**, 1022.
- 17 S. Khan, R. Michel, J. M. Dieterich, R. A. Mata, H. W. Roesky, J.-P. Demers, A. Lange and D. Stalke, *J. Am. Chem. Soc.*, 2011, **133**, 17889.
- 18 (a) A. H. Cowley and R. A. Kemp, *Chem. Rev.*, 1985, **85**, 367; (b) D. Gudat, *Coord. Chem. Rev.*, 1997, **163**, 71.
- 19 J. M. Slattery and S. Hussein, *Dalton Trans.*, 2012, **41**, 1808.
- 20 (a) M. H. Holthausen and J. J. Weigand, *Z. Anorg. Allg. Chem.*, 2012, **638**, 1103; (b) C. Hering, A. Schulz and A. Villinger, *Angew. Chem., Int. Ed.*, 2012, **51**, 6241; (c) C. Hering, A. Schulz and A. Villinger, *Inorg. Chem.*, 2013, **52**, 5214.
- 21 (a) R. W. Reed, Z. Xie and C. A. Reed, *Organometallics*, 1995, **14**, 5002; (b) A. Dumitrescu, H. Gornitzka, W. W. Schoeller, D. Bourissou and G. Bertrand, *Eur. J. Inorg. Chem.*, 2002, 1953.
- 22 (a) F. S. Shagvaleev, T. V. Zykova, R. I. Tarasova, T. S. Sitdikova and V. V. Moskva, *Zh. Obshch. Khim.*, 1990, **60**, 1775; (b) N. Burford, T. S. Cameron, D. J. LeBlanc, P. Losier, S. Sereda and G. Wu, *Organometallics*, 1997, **16**, 4712.
- 23 N. Burford, T. S. Cameron and P. J. Ragogna, *J. Am. Chem. Soc.*, 2001, **123**, 7947.
- 24 J. M. Slattery, C. Fish, M. Green, T. N. Hooper, J. C. Jeffery, R. J. Kilby, J. M. Lynam, J. E. McGrady, D. A. Pantazis, C. A. Russel and C. E. Williams, *Chem. – Eur. J.*, 2007, **13**, 6967.
- 25 M. B. Abrams, B. L. Scott and R. T. Baker, *Organometallics*, 2000, **19**, 4944.
- 26 N. Burford, C. A. Dyker and A. Decken, *Angew. Chem., Int. Ed.*, 2005, **44**, 2364.
- 27 J. J. Weigand, N. Burford, M. D. Lumsden and A. Decken, *Angew. Chem., Int. Ed.*, 2006, **45**, 6733.
- 28 J. J. Weigand, N. Burford and A. Decken, *Eur. J. Inorg. Chem.*, 2008, 4343.
- 29 T. P. Martin, *Z. Phys. D Atom. Mol. Cl.*, 1986, **3**, 211.
- 30 (a) M. D. Chen, R. B. Huang, L. S. Zheng, Q. E. Zhang and C. T. Au, *Chem. Phys. Lett.*, 2000, **325**, 22; (b) T. Xue, J. Luo, S. Shen, F. Li and J. Zhao, *Chem. Phys. Lett.*, 2010, **485**, 26.
- 31 T. A. Engesser and I. Krossing, *Coord. Chem. Rev.*, 2013, **257**, 946.
- 32 I. Krossing, *J. Chem. Soc., Dalton Trans.*, 2002, 500.
- 33 T. Köchner, S. Riedel, A. J. Lehner, H. Scherer, I. Raabe, T. A. Engesser, F. W. Scholz, U. Gellrich, P. Eiden, R. A. Paz Schmidt, D. A. Plattner and I. Krossing, *Angew. Chem., Int. Ed.*, 2010, **49**, 8139.
- 34 C. Bolli, T. Köchner and C. Knapp, *Z. Anorg. Allg. Chem.*, 2012, **638**, 559.
- 35 T. Köchner, T. A. Engesser, H. Scherer, A. D. Plattner, A. Steffani and I. Krossing, *Angew. Chem., Int. Ed.*, 2012, **51**, 6529.
- 36 I. Krossing and I. Raabe, *Angew. Chem., Int. Ed.*, 2001, **40**, 4406.
- 37 (a) M. Gonsior, I. Krossing, L. Müller, I. Raabe, M. Jansen and L. van Wüllen, *Chem. – Eur. J.*, 2002, **8**, 4475; (b) I. Krossing, *J. Chem. Soc., Dalton Trans.*, 2002, 500.
- 38 A. Bihlmeier, M. Gonsior, I. Raabe, N. Trapp and I. Krossing, *Chem. – Eur. J.*, 2004, **10**, 5041.
- 39 M. H. Holthausen, K.-O. Feldmann, S. Schulz, A. Hepp and J. J. Weigand, *Inorg. Chem.*, 2012, **51**, 3374.
- 40 (a) Y. Kashman, Y. Menachem and E. Benary, *Tetrahedron*, 1973, **29**, 4279; (b) P. Crews, *J. Org. Chem.*, 1975, **40**, 1170; (c) Y. Kashman and A. Rudi, *Tetrahedron Lett.*, 1976, **32**, 2819; (d) A. Rudi and Y. Kashman, *Tetrahedron Lett.*, 1978, **25**, 2209; (e) A. H. Cowley, C. A. Stewart, B. R. Whittlesey and T. C. Wright, *Tetrahedron Lett.*, 1984, **25**, 815.
- 41 C. Symmes and L. D. Quin, *J. Org. Chem.*, 1978, **43**, 1250.
- 42 Y. Carpenter, N. Burford, M. D. Lumsden and R. McDonald, *Inorg. Chem.*, 2011, **50**, 3342.
- 43 S. Ulvenlund, A. Whaetley and L. A. Bengtsson, *J. Chem. Soc., Dalton Trans.*, 1995, 245.
- 44 (a) D. Gudat, *Eur. J. Inorg. Chem.*, 1998, 1087; (b) M. Gonsior, I. Krossing and E. Matern, *Chem. – Eur. J.*, 2006, **12**, 1703.
- 45 (a) M. Baudler, C. Adamek, S. Opiela, H. Budzikiewicz and D. Ouzounis, *Angew. Chem., Int. Ed.*, 1988, **27**, 1059; (b) P. Jutzi and U. Meyer, *J. Organomet. Chem.*, 1987, **333**, C18.
- 46 (a) R. K. Harris, E. M. Norval and M. Fild, *J. Chem. Soc., Dalton Trans.*, 1979, 826; (b) J. J. Weigand, S. D. Riegel, N. Burford and A. Decken, *J. Am. Chem. Soc.*, 2007, **129**, 7969.
- 47 (a) S. O. Grim, W. McFarlane, E. F. Davidoff and T. J. Marks, *J. Phys. Chem.*, 1966, **70**, 581; (b) S. O. Grim and W. McFarlane, *Can. J. Chem.*, 1968, **46**, 2071.
- 48 (a) G. Trinqueler and M.-R. Marre, *J. Phys. Chem.*, 1983, **87**, 1903; (b) A. H. Cowley, M. C. Crushner, M. Lattman, M. L. McKee, J. S. Szobota and J. C. Wilburn, *Pure Appl. Chem.*, 1980, **52**, 789; (c) W. W. Schoeller and U. Tubbesing, *THEOCHEM*, 1995, **343**, 49.
- 49 M. H. Holthausen, A. Hepp and J. J. Weigand, *Chem. – Eur. J.*, 2013, **19**, 9895.
- 50 B. D. Ellis, P. J. Ragogna and C. L. B. McDonald, *Inorg. Chem.*, 2004, **43**, 7857.
- 51 J. J. Weigand, M. H. Holthausen and R. Fröhlich, *Angew. Chem., Int. Ed.*, 2009, **48**, 295.
- 52 (a) M. Baudler, W. Faber and J. Hahn, *Z. Anorg. Allg. Chem.*, 1980, **469**, 15; (b) G. Fritz, H. Rothmann and E. Matern, *Z. Anorg. Allg. Chem.*, 1992, **610**, 33; (c) I. Kovacs, G. Baum, G. Fritz, D. Fenske, N. Wiberg, H. Schuster and K. Karaghiosoff, *Z. Anorg. Allg. Chem.*, 1993, **619**, 453; (d) S. Charles, J. C. Fettinger and B. W. Eichorn, *J. Am. Chem. Soc.*, 1995, **117**, 5303.
- 53 (a) G. Fritz and K. D. Hoppe, *J. Organomet. Chem.*, 1983, **249**, 63; (b) V. A. Milyukov, A. V. Kataev, E. Hey-Hawkins and O. G. Sinyshin, *Russ. Chem. Bull.*, 2007, **56**, 298; (c) M. Baudler and R. Riekenhof-Böhmer, *Z. Naturforsch., B: J. Chem. Sci.*, 1985, **40**, 1424; (d) M. Baudler and T. Pontzen, *Z. Naturforsch., B: J. Chem. Sci.*, 1983, **38**, 955; (e) G. Fritz and W. Hölderich, *Naturwissenschaften*, 1975, **62**, 573.



- 54 Y. C. Leung, J. Waser, v. S. Houten, A. Vos, G. A. Wiegers and E. H. Wiebenga, *Acta Crystallogr.*, 1957, **10**, 574.
- 55 D. Gudat, *Top. Heterocycl. Chem.*, 2010, **21**, 63.
- 56 (a) G. David, E. Niecke, M. Nieger, V. von der Gönna and W. W. Schoeller, *Chem. Ber.*, 1993, **126**, 1513; (b) N. Burford, T. S. Cameron, K. D. Conroy, B. Ellis, M. Lumsden, C. L. B. McDonald, R. McDonald, A. D. Philips, P. J. Ragogna, R. W. Schurko, D. Walsh and R. E. Wasylshen, *J. Am. Chem. Soc.*, 2002, **124**, 14012; (c) J. R. Davidson, J. J. Weigand, N. Burford, T. S. Cameron, A. Decken and U. Werner-Zwanziger, *Chem. Commun.*, 2007, 4671; (d) D. Michalik, A. Schulz, A. Villinger and N. Wedling, *Angew. Chem., Int. Ed.*, 2008, **47**, 6465.
- 57 M. H. Holthausen and J. J. Weigand, *J. Am. Chem. Soc.*, 2009, **131**, 14210.
- 58 Unpublished results.
- 59 M. H. Holthausen, C. Richter, A. Hepp and J. J. Weigand, *Chem. Commun.*, 2010, **46**, 6921.
- 60 E. Niecke and R. Kröher, *Angew. Chem., Int. Ed. Engl.*, 1976, **15**, 692.
- 61 A. F. Hollemann and E. Wiberg, *Lehrbuch der Anorganischen Chemie*, W. d. Gruyter, Berlin, New York, 102nd edn, 2007.
- 62 M. Gonsior, I. Krossing and E. Matern, *Chem. – Eur. J.*, 2006, **12**, 1986.
- 63 B. W. Tattershall, *J. Chem. Soc., Dalton Trans.*, 1988, 2055.
- 64 W. Hönle and H. G. v. Schnering, *Z. Anorg. Allg. Chem.*, 1978, **440**, 171.
- 65 M. Baudler, *Angew. Chem., Int. Ed. Engl.*, 1987, **26**, 419.
- 66 O. Back, G. Kuchenbeiser, B. Donnadieu and G. Bertrand, *Angew. Chem., Int. Ed.*, 2009, **48**, 5530.
- 67 M. H. Holthausen, S. K. Surmiak, P. Jerabek, G. Frenking and J. J. Weigand, *Angew. Chem., Int. Ed.*, 2013, **52**, 11078.
- 68 L. Weber, *Eur. J. Inorg. Chem.*, 2000, 2425; a P₃ chain similar to fragmentation product **71**⁺ was reported shortly after this review was completed, see A. M. Tondreau, Z. Benkő, J. R. Harmer and H. Grützmacher, *Chem. Sci.*, 2014, **5**, 1545.
- 69 L. Weber, *Chem. Rev.*, 1992, **92**, 1839.
- 70 (a) O. Back, B. Donnadieu, P. Parameswaran, G. Frenking and G. Bertrand, *Nat. Chem.*, 2010, **2**, 369; (b) J. J. Weigand, K.-O. Feldmann and F. D. Henne, *J. Am. Chem. Soc.*, 2010, **132**, 16321.
- 71 (a) F. D. Henne, E.-M. Schnökelborg, K.-O. Feldmann, J. Grunenberg, R. Wolf and J. J. Weigand, *Organometallics*, 2013, **32**, 6674; (b) K. Schwedtmann, M. H. Holthausen, K.-O. Feldmann and J. J. Weigand, *Angew. Chem., Int. Ed.*, 2013, **52**, 11078.

