

Cite this: *Nanoscale Adv.*, 2019, 1, 154

# Rational design of C<sub>2</sub>N-based type-II heterojunctions for overall photocatalytic water splitting†

Xu Zhang, An Chen, Zihe Zhang, Menggai Jiao and Zhen Zhou \*

Photocatalytic water splitting is a promising method for the production of clean energy and searching for efficient photocatalysts has received extensive attention. Fabricating type-II heterojunctions is an effective approach to improve the photocatalytic efficiency. Based on the band edge positions and lattice parameters, we found that several kinds of monochalcogenide monolayers can be used to fabricate type-II heterojunctions with C<sub>2</sub>N monolayers. C<sub>2</sub>N/GaTe and C<sub>2</sub>N/InTe van der Waals (vdW) heterojunctions were investigated as potential photocatalysts for water splitting by means of first-principles computations. Both are type-II heterojunctions, and could promote the efficient spatial separation of electron–hole pairs. Their band edges straddle water redox potentials, satisfying the requirements for photocatalytic water splitting. Besides, the high carrier mobility of C<sub>2</sub>N/GaTe and C<sub>2</sub>N/InTe heterojunctions implies that the transfer of carriers to reactive sites is easy, and the recombination probability of photo-generated carriers is reduced. The Gibbs free energy calculations indicate that C<sub>2</sub>N/GaTe and C<sub>2</sub>N/InTe heterojunctions, especially C<sub>2</sub>N/InTe, exhibit high catalytic performance towards hydrogen and oxygen evolution reactions. Particularly, C<sub>2</sub>N/InTe exhibits a direct band gap with strong absorption in both visible and near ultraviolet regions, indicating that it is a very promising candidate for photocatalytic water splitting. This work would provide a new idea for the development of type-II heterojunctions for photocatalytic water splitting.

Received 12th July 2018  
Accepted 10th September 2018

DOI: 10.1039/c8na00084k

rsc.li/nanoscale-advances

## Introduction

Photocatalytic water splitting is a promising technology to produce hydrogen with sunlight, providing a sustainable solution to address environmental and energy related issues.<sup>1,2</sup> The first significant breakthrough in photocatalytic overall water splitting without electric power was achieved by Fujishima and Honda.<sup>3</sup> Since then, many photocatalysts have been developed.<sup>4–10</sup> However, industrial hydrogen is primarily produced from fossil fuels since the current photocatalytic systems are not efficient and economical enough for industrial hydrogen production.<sup>4</sup> A low quantum yield, inability to utilize visible light and poor catalytic activity are critical obstacles for the commercial application of photocatalytic water splitting.<sup>11,12</sup> Therefore, the discovery of novel photohydrolytic catalysts with high efficiency plays a critical role in the development of photocatalytic water splitting.

Nanoscale materials with adjustable dimensions and shapes are one of the most promising photohydrolytic catalysts. Among various kinds of nanoscale materials, two-dimensional (2D) materials possess two main inherent advantages which can be used to improve the photocatalytic efficiency for water splitting.<sup>11,13–15</sup> First, 2D materials have a high surface to volume ratio, exhibiting a large specific surface area available for photocatalytic reactions and promoting the adsorption of reactants. Besides, the distance that photo-generated electrons and holes have to migrate in 2D materials is short, reducing the possibility of electron–hole recombination, thereby potentially enhancing photocatalytic activity. With the rapid development of high-performance computations, various 2D materials were designed and predicted to be promising photocatalysts for overall water splitting.<sup>11,12,15,16</sup> The computations have promoted the development of photocatalysts and some 2D materials have been proved to be good photocatalysts for water splitting in experiments, such as g-C<sub>3</sub>N<sub>4</sub> (ref. 17) and MPS<sub>3</sub> (M = Fe or Mn).<sup>18,19</sup>

Besides, fabricating van der Waals (vdW) heterojunctions is an effective method to further improve the photocatalytic performance.<sup>20,21</sup> Especially, in type-II heterojunctions, both the conduction band minimum (CBM) and valence band maximum (VBM) of one layer are lower than that of the other layer. Therefore, the lowest energy states of electrons and holes are on

School of Materials Science and Engineering, National Institute for Advanced Materials, Institute of New Energy Material Chemistry, Computational Centre for Molecular Science, Nankai University, Tianjin 300350, P. R. China. E-mail: zhouzhen@nankai.edu.cn; Fax: +86 22 23498941; Tel: +86 22 23503623

† Electronic supplementary information (ESI) available. See DOI: 10.1039/c8na00084k



different layers, ensuring the effective separation of photo-generated electrons and holes. In our previous reports, we proposed a high-throughput computational material design framework to search for 2D photocatalysts and rationally design type-II heterojunctions for water splitting based on the Materials Project Database.<sup>15</sup> Various kinds of type-II heterojunctions were successfully designed. However, due to the rapid development of 2D materials, several novel kinds of materials, which have not been included in materials databases, have been successfully prepared in experiments. Therefore, predicting type-II heterojunctions containing novel kinds of 2D materials is necessary to evaluate their photocatalytic activity.

Recently, a novel kind of 2D material, named C<sub>2</sub>N, has been successfully prepared by simple wet chemical reactions.<sup>22</sup> By means of first-principles computations, C<sub>2</sub>N monolayers were predicted to be a promising photocatalyst for water splitting.<sup>23</sup> In experiments, vdW heterojunctions composed of C<sub>2</sub>N and azo-conjugated microporous polymers were prepared, which exhibit good photocatalytic performance for overall water splitting.<sup>24</sup> Enlightened by the computational and experimental results, we screened the 2D monolayer materials in our previous work<sup>15</sup> to explore the materials which could be used to fabricate type-II heterojunctions with C<sub>2</sub>N monolayers to further improve their photocatalytic performance. The screening criteria are consistent with our previous report.<sup>15</sup> First, the CBM and VBM of the layer should be lower or higher than that of C<sub>2</sub>N, respectively. Then the lattice parameters of the layer should be close to those of C<sub>2</sub>N (lattice mismatch <10%), which could reduce the strain, improving the stability. This could also be achieved by constructing supercells. Considering the computational cost, small supercells, such as 2 × 2 × 1 supercells, were considered. Our results indicate that transition metal monochalcogenides and dichalcogenides could be used to fabricate type-II vdW heterojunctions with C<sub>2</sub>N. Recently, C<sub>2</sub>N/WS<sub>2</sub> vdW type-II heterojunctions were proposed as promising photocatalysts for water splitting.<sup>25</sup>

Therefore, in this work, we focused on monochalcogenide/C<sub>2</sub>N heterojunctions. Based on the calculated band structures,<sup>26</sup> besides GaTe which was proposed in our previous report,<sup>15</sup> some other monochalcogenides, including GaSe and InTe, were also investigated. By means of first-principles computations, we designed GaSe/C<sub>2</sub>N, GaTe/C<sub>2</sub>N and InTe/C<sub>2</sub>N vdW heterojunctions and investigated their stability, electronic, optical properties, carrier mobility and catalytic performance towards the hydrogen evolution reaction (HER) and oxygen evolution reaction (OER). The results indicate that GaTe/C<sub>2</sub>N and InTe/C<sub>2</sub>N are type-II heterojunctions, implying the efficient separation of holes and electrons, thereby preventing their recombination. The exciton binding energies of GaTe/C<sub>2</sub>N and InTe/C<sub>2</sub>N type-II heterojunctions are lower than that of C<sub>2</sub>N, indicating better separation of the bound holes and electrons to free charge carriers. Both GaTe/C<sub>2</sub>N and InTe/C<sub>2</sub>N exhibit high carrier mobility, indicating high photocatalytic activity. Besides, InTe/C<sub>2</sub>N exhibits an excellent catalytic performance towards the HER and OER, further proving InTe/C<sub>2</sub>N type-II heterojunctions to be a promising candidate for overall photocatalytic water splitting.

## Computational methods

First-principles computations on the basis of density functional theory (DFT) were performed by using a plane-wave basis set as implemented in the Vienna ab initio simulation package (VASP).<sup>27</sup> Ion-electron interactions were described with the projector augmented wave (PAW) method<sup>28</sup> and an energy cutoff of 550 eV was adopted for the plane-wave basis set. The generalized gradient approximation (GGA) involving the Perdew, Burke, and Ernzerhof (PBE) functional was selected to describe the exchange correlation energy.<sup>29</sup> The effect of the vdW interactions was dealt with the DFT-D3 method with Becke–Johnson damping.<sup>30,31</sup> A Monkhorst–Pack *k*-point mesh<sup>32</sup> of 5 × 5 × 1 was employed for C<sub>2</sub>N and heterojunctions and 10 × 10 × 1 for monochalcogenide (MX, M = Ga, In, X = Se, Te) monolayers. In order to prevent the artificial interactions between periodic images, a vacuum space with at least 20 Å was inserted between the periodic images along the *z*-direction. Since the GGA functional systematically underestimates the band gaps,<sup>33</sup> we used the Heyd–Scuseria–Ernzerhof (HSE06) functional<sup>34</sup> to accurately compute the band structures and band edge positions.

The binding energy of vdW heterojunctions was calculated based on:

$$E_{\text{binding}} = E_{\text{heterojunction}} - E_{\text{C}_2\text{N}} - E_{\text{MX}}$$

where  $E_{\text{heterojunction}}$ ,  $E_{\text{C}_2\text{N}}$  and  $E_{\text{MX}}$  represent the total energies of the heterojunctions, C<sub>2</sub>N and monochalcogenides (GaSe, GaTe and InTe), respectively.

For inorganic semiconductors, the phonon scattering dominates the intrinsic mobility which could be described by deformation potential (DP) theory.<sup>35</sup> DP theory has been successfully used in predicting the carrier mobility of 2D semiconductors, including graphene,<sup>36</sup> phosphorene,<sup>37</sup> MoS<sub>2</sub>,<sup>38</sup> MXenes<sup>39</sup> and so on.<sup>16,40</sup> Therefore, the carrier mobility ( $\mu_{2\text{D}}$ ) of isolated C<sub>2</sub>N, GaTe, and InTe monolayers and heterojunctions could be predicted by using the phonon limited scattered mode on the basis of effective mass approximation with DP theory according to:

$$\mu_{2\text{D}} = \frac{2e\hbar^3 C}{3k_{\text{B}} T |m^*|^2 E_1^2}$$

in which  $\hbar$  is the reduced Planck constant,  $e$  is the electron charge,  $T$  is the temperature and set to be 300 K, and  $C$  represents the in-plane stiffness and is given by  $C = (\partial^2 E_{\text{total}} / \partial \varepsilon^2) / S_0$ , where  $E_{\text{total}}$ ,  $\varepsilon$  and  $S_0$  represent the total energy of a cell, the uniaxial strain and the area of an optimized cell.  $m^*$  is the effective mass and calculated by using  $m^* = \hbar^2 (\partial^2 E(k) / \partial k^2)^{-1}$ , in which  $k$  is the wave vector and  $E(k)$  means the energy at the corresponding wave vector  $k$ .  $E_1$  is the DP constant calculated by using  $E_1 = \partial E_{\text{edge}} / \partial \varepsilon$ , where  $E_{\text{edge}}$  is the energy of the CBM and VBM along the transport direction. Considering the time consumption, the carrier mobility was calculated with the PBE functional.

To investigate the optical absorption, the imaginary part of the dielectric function  $\varepsilon_2$  was calculated based on the following equation:<sup>41</sup>



$$\varepsilon_{\alpha\beta}^2(\omega) = \frac{4\pi^2 e^2}{\Omega} \lim_{q \rightarrow 0} \frac{1}{q^2} \sum_{c,\nu,\vec{k}} 2W_{\vec{k}} \delta(\varepsilon_{c\vec{k}} - \varepsilon_{\nu\vec{k}} - \omega) \times \langle u_{c\vec{k}+e_a\vec{q}} | u_{\nu\vec{k}} \rangle \langle u_{c\vec{k}+e_b\vec{q}} | u_{\nu\vec{k}} \rangle^*$$

where  $c$  and  $\nu$  refer to the conduction and valence band states, respectively, and both were determined by using the HSE06 functional here.  $u_{c\vec{k}}$  represents the cell periodic part of the orbital at the  $k$ -point  $\vec{k}$ . The real part is obtained by using the Kramers–Kronig relationship:<sup>42</sup>

$$\varepsilon_{\alpha\beta}^1(\omega) = 1 + \frac{2}{\pi} P \int_0^\infty \frac{\varepsilon_{\alpha\beta}^2(\omega') \omega'}{\omega'^2 - \omega^2 + i\eta} d\omega'$$

where  $P$  indicates the principal value. The absorption coefficient  $\alpha(\omega)$  was computed by using<sup>43</sup>

$$\alpha(\omega) = \sqrt{2\omega} \left( \sqrt{\varepsilon_1^2(\omega) + \varepsilon_2^2(\omega)} - \varepsilon_1(\omega) \right)^{1/2}$$

where  $\varepsilon_1$  is the real part of the dielectric function, obtained from  $\varepsilon_2$  by using the Kramer–Kronig relationship.

The HER catalytic performance of the heterojunctions was evaluated by calculating the Gibbs free energy change of the adsorption of atomic hydrogen ( $\Delta G_{\text{H}}$ ):

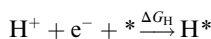

in which  $*$  represents the active sites and  $\text{H}^*$  represents the adsorbed intermediates. According to the computational hydrogen electrode model,<sup>44</sup> the chemical potential of the  $\text{H}^+/\text{e}^-$  pair under the standard conditions of  $\text{pH} = 0$  is equal to half that of  $\text{H}_2$  at a potential of 0 V. Here,  $\Delta G_{\text{H}}$  can be calculated by using

$$\Delta G_{\text{H}} = \Delta E_{\text{H}} + \Delta E_{\text{ZPE}} - T\Delta S_{\text{H}}$$

$\Delta E_{\text{H}}$  represents the adsorption energy of one hydrogen atom and can be calculated based on:  $\Delta E_{\text{H}} = E_{\text{nH}} - E_{(n-1)\text{H}} - 1/2E_{\text{H}_2}$ , where  $E_{\text{nH}}$  and  $E_{(n-1)\text{H}}$  stand for the total energy of the heterojunction with  $n$  and  $n - 1$  hydrogen atoms adsorbed, respectively, and  $E_{\text{H}_2}$  represents the total energy of gas phase  $\text{H}_2$  calculated by DFT.  $\Delta E_{\text{ZPE}}$  means the difference of the zero-point energy between the  $n$ -th adsorbed hydrogen and half of the gas phase hydrogen.  $\Delta S_{\text{H}}$  is the entropy change between the adsorbed state and gas phase. The entropy of the adsorbed state was calculated by using<sup>45</sup>

$$S(T) = \sum_{i=1}^{3N} \left[ -R \ln \left( 1 - e^{-\frac{h\nu_i}{k_{\text{B}}T}} \right) + \frac{N_{\text{A}} h\nu_i}{T} \frac{e^{-h\nu_i/k_{\text{B}}T}}{1 - e^{-h\nu_i/k_{\text{B}}T}} \right]$$

where  $R$  is the universal gas constant,  $h$  is Planck's constant,  $\nu_i$  is the normal mode frequency,  $N_{\text{A}}$  is Avogadro's number and  $N$  represents the number of the adsorbed atoms. The  $\Delta G_{\text{H}}$  of a good catalyst for the HER should be close to zero.

Under acidic conditions, the mechanism for the OER process is:

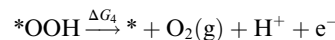
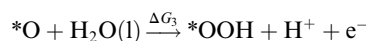
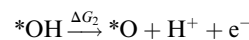
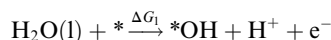

where (l) represents the liquid phase and (g) refers to the gas phase. To estimate the OER activity, the free energy change ( $\Delta G$ ) of the OER elementary steps should be calculated by:

$$\Delta G = \Delta E + \Delta E_{\text{ZPE}} - T\Delta S + \Delta G_{\text{U}} + \Delta G_{\text{pH}}$$

where  $\Delta E$  means the reaction energy which could be obtained by DFT computations.  $\Delta G_{\text{U}} = -eU$  and  $U$  is the electrode potential.  $\Delta G_{\text{pH}}$  denotes the correction of the  $\text{H}^+$  free energy by the concentration dependence of the entropy and is given by:  $\Delta G_{\text{pH}} = k_{\text{B}}T \ln 10 \times \text{pH}$ . Because of the inaccuracy of DFT in estimating the binding energy of  $\text{O}_2$ , the free energy of  $\text{O}_2$  was calculated according to the free energy change of  $\text{O}_2 + 2\text{H}_2 \rightarrow 2\text{H}_2\text{O}$ , which is  $-4.92$  eV.

In order to evaluate the efficiency of the separation of photo-generated charge carriers, the exciton binding energies ( $E_{\text{b}}$ ) were calculated based on the Mott–Wannier hydrogenic model. In a previous report, the exciton binding energies of  $\text{C}_2\text{N}$  containing vdW heterojunctions were calculated based on:<sup>25</sup>

$$E_{\text{b}} = \frac{13.6\mu_{\text{ex}}}{m_{\text{e}}\varepsilon^2}$$

$$\mu_{\text{ex}} = \frac{m_{\text{e}}m_{\text{h}}}{m_{\text{e}} + m_{\text{h}}}$$

where  $\mu_{\text{ex}}$  is the effective exciton mass and  $\varepsilon$  is the macroscopic static dielectric constant which is the sum of the ionic  $\varepsilon_{\text{ion}}$  and electronic  $\varepsilon_{\text{el}}$  contributions.

## Results and discussion

### Geometric structure and electronic properties of isolated monolayers

First the geometric structures of isolated monolayers were optimized and are shown in Fig. S1.† The lattice parameters are listed in Table S1,† which are consistent with reported values.<sup>26,46</sup>

Then the electronic properties of these monolayers were investigated at the HSE06 level as shown in Fig. S2.† The  $\text{C}_2\text{N}$  monolayer exhibits a direct band gap of 2.49 eV at the  $\Gamma$  point of the Brillouin zone, which agrees well with those in previous reports.<sup>23,46</sup> The MX monolayers (GaSe, GaTe and InTe) exhibit indirect band gaps of 2.97, 2.21 and 2.21 eV, respectively. For GaSe and InTe monolayers, the CBM is at the  $\Gamma$  point while the VBM is located between the  $\Gamma$  and  $K$  points. For the GaTe monolayer, the CBM is located at the  $M$  point. These computational results are consistent with those in the previous report,<sup>26</sup> indicating the reliability of our results.



### Geometric structure and stability of heterojunctions

In order to match the lattice and reduce the strain, the  $C_2N/MX$  heterojunctions were constructed based on the unit cell of  $C_2N$  and  $2 \times 2 \times 1$  supercells of  $MX$  monolayers. Three high symmetry stacking patterns (Fig. S3<sup>†</sup>) were considered in this work. For pattern a, all the  $MX$  atoms are on the top of the hollow sites of the  $C_2N$  monolayers. For patterns b and c, several  $MX$  atoms are located on the top of  $C_2N$  atoms. The relative binding energies are shown in Table S2.<sup>†</sup> For all the heterojunctions, pattern a is the most stable structure and was used in the following computations.

The geometric structures, lattice parameters and binding energies of the most stable structure for the three heterojunctions are summarized in Fig. 1 and Table S3.<sup>†</sup> The distance between the  $C_2N$  and  $MX$  monolayers in these heterojunctions is about 3.40 Å (Table S3<sup>†</sup>), implying that the vdW effect plays the primary role in the interlayer interaction. Due to the large lattice mismatch for  $C_2N/GaSe$  (Table S3<sup>†</sup>), the binding energy is positive, indicating that it is unstable. For  $C_2N/GaTe$  and  $C_2N/InTe$ , their lattice mismatch is lower than 3%, ensuring the experimental feasibility. Besides, the binding energies of  $C_2N/GaTe$  and  $C_2N/InTe$  are  $-10.8$  and  $-9.6$  meV Å<sup>-2</sup>, respectively, which are comparable to those of some typical vdW crystals, including  $MoS_2$  ( $-26.0$  meV Å<sup>-2</sup>)<sup>47</sup> and graphene ( $-12.0$  meV Å<sup>-2</sup>),<sup>48</sup> and some vdW heterojunctions, such as  $GaSe/graphene$  ( $-18.4$  meV Å<sup>-2</sup>)<sup>49</sup> and  $C_3N_4/MoS_2$  ( $-17.8$  meV Å<sup>-2</sup>).<sup>50</sup> These results further indicate that  $C_2N/GaTe$  and  $C_2N/InTe$  are stable.  $C_2N/GaTe$  and  $C_2N/InTe$  heterojunctions were investigated in the following computations.

### Electronic and optical properties of heterojunctions

The electronic properties are extremely important for photocatalysts. The band structures of  $C_2N/GaTe$  and  $C_2N/InTe$  heterojunctions were calculated with the HSE06 functional as shown in Fig. 2.

The band gaps of  $C_2N/GaTe$  and  $C_2N/InTe$  heterojunctions are 1.43 and 1.52 eV, respectively, which are lower than those of isolated monolayers. The CBM of  $C_2N/GaTe$  and  $C_2N/InTe$

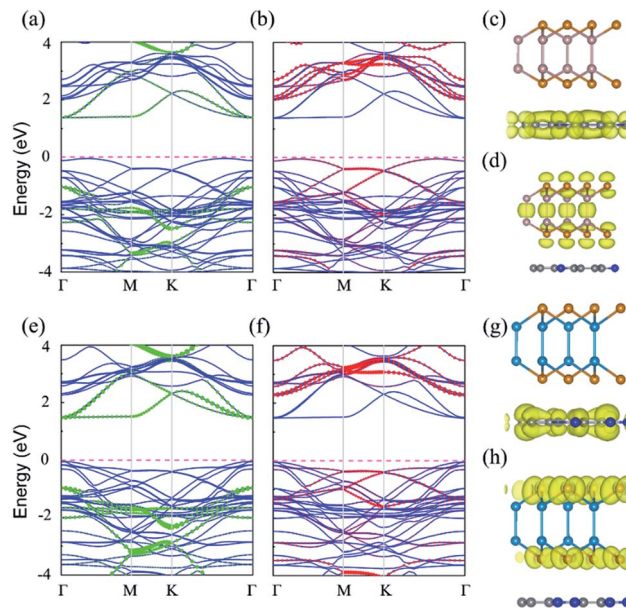

Fig. 2 Band structures of the  $C_2N/GaTe$  heterojunction projected to (a)  $C_2N$  and (b)  $GaTe$ , respectively computed with the HSE06 functional. Band structures of the  $C_2N/InTe$  heterojunction projected to (e)  $C_2N$  and (f)  $InTe$ , respectively. The sizes of green and red dots represent the weight of  $C_2N$  and  $GaTe$  ( $InTe$ ). Spatial structures of wave functions for the  $C_2N/GaTe$  heterojunction at the (c) CBM and (d) VBM with an isosurface of  $0.002 e \text{ \AA}^{-3}$ . Spatial structures of wave functions for the  $C_2N/InTe$  heterojunction at the (g) CBM and (h) VBM with an isosurface of  $0.002 e \text{ \AA}^{-3}$ .

heterojunctions both are located at the  $\Gamma$  point. The VBM of  $C_2N/GaTe$  is located between the  $\Gamma$  and  $K$  points while the VBM of  $C_2N/InTe$  is at the  $\Gamma$  point. Therefore,  $C_2N/InTe$  transfers to a direct band gap semiconductor while  $C_2N/GaTe$  still possesses an indirect band gap. As shown in Fig. 2, the CBM of the heterojunctions is mainly contributed by  $C_2N$  while the VBM mostly comes from the  $MX$ . Therefore, both  $C_2N/GaTe$  and  $C_2N/InTe$  possess a typical type-II band alignment, which promotes the efficient spatial separation of electron-hole pairs, overcoming the electron-hole recombination issue. The conduction band offset (CBO) and valence band offset (VBO) were calculated to be 0.65 and 1.00 eV for  $C_2N/GaTe$  and 0.79 and 0.92 eV for  $C_2N/InTe$ . The photogenerated electrons in the CBM of  $GaTe$  or  $InTe$  could transfer to the CBM of  $C_2N$  by the chemical potential difference of CBO while the photogenerated holes in the VBM of  $C_2N$  can migrate to the VBM of  $GaTe$  or  $InTe$  via the chemical potential difference of VBO. The results further ensure the effective spatial separation of electron-hole pairs.

Besides, the partial density of states (PDOS) was also calculated to gain deep insight into the composition of the VBM and CBM of the heterojunctions as shown in Fig. S4.<sup>†</sup> The CBM mainly originates from the p states of C and N atoms while the VBM is contributed by the p states of Te and Ga (or In) atoms.

A fundamental requirement for photocatalysts for overall water splitting is that the band edges should straddle the water redox potentials. That is to say, the VBM must be lower than the oxidation potential of  $O_2/H_2O$  and the CBM should be higher than the reduction potential of  $H^+/H_2$ . Besides, the

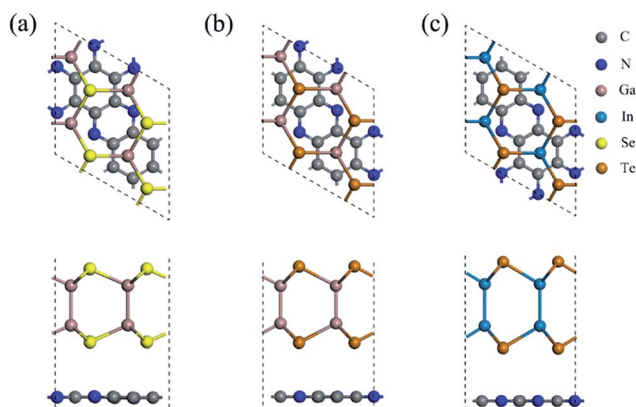

Fig. 1 Top and side views of (a)  $C_2N/GaSe$ , (b)  $C_2N/GaTe$  and (c)  $C_2N/InTe$  heterojunctions.



water redox potential is influenced by the pH value.<sup>12,15</sup> Here, the reduction potential of  $\text{H}^+/\text{H}_2$  is calculated by using:  $E_{\text{H}^+/\text{H}_2}^{\text{red}}(\text{vs. vacuum}) = -4.44 \text{ eV} + \text{pH} \times 0.059 \text{ eV}$  and the oxidation potential of  $\text{O}_2/\text{H}_2\text{O}$  is  $E_{\text{O}_2/\text{H}_2\text{O}}^{\text{ox}}(\text{vs. vacuum}) = -5.67 \text{ eV} + \text{pH} \times 0.059 \text{ eV}$ . The schematic diagram for the band edge positions relative to the vacuum level of the isolated monolayers and heterojunctions is shown in Fig. 3. The band edges of all the isolated monolayers ( $\text{C}_2\text{N}$ , GaSe, GaTe and InTe) and  $\text{C}_2\text{N}/\text{InTe}$  heterojunction straddle the redox potentials of water at  $\text{pH} = 0$ . However, the VBM of the  $\text{C}_2\text{N}/\text{GaTe}$  heterojunction is higher than the oxidation potential of  $\text{O}_2/\text{H}_2\text{O}$  at  $\text{pH} = 0$ . An appropriate pH value of 1.60–4.98 is needed for the  $\text{C}_2\text{N}/\text{GaTe}$  heterojunction for photocatalytic water splitting. The results suggest that the constructed  $\text{C}_2\text{N}/\text{GaTe}$  and  $\text{C}_2\text{N}/\text{InTe}$  heterojunctions are promising candidates for photocatalytic water splitting without an external bias voltage at appropriate pH. Interestingly, the  $\text{C}_2\text{N}/\text{InTe}$  heterojunction exhibits a direct band gap.

Compared with the isolated monolayers, the band edge positions of the CBM and VBM in the heterojunctions are located closer to the redox potentials of water, suggesting higher photocatalytic efficiency and optical absorption.<sup>51</sup> In order to investigate the optical absorption, the average absorption coefficients of  $x$ ,  $y$  and  $z$  directions were calculated as shown in Fig. 4. Besides, the imaginary parts of the dielectric function are also shown in Fig. S5.† As shown in Fig. 4 and S5,† the  $\text{C}_2\text{N}$  monolayer possesses absorption peaks in the visible spectrum while GaTe and InTe monolayers exhibit broad absorption in the near ultraviolet region. Fascinatingly,  $\text{C}_2\text{N}/\text{GaTe}$  and  $\text{C}_2\text{N}/\text{InTe}$  heterojunctions exhibit strong absorption in both visible and near ultraviolet regions with an intensity of  $10^5 \text{ cm}^{-1}$ . Therefore, both the  $\text{C}_2\text{N}/\text{GaTe}$  and  $\text{C}_2\text{N}/\text{InTe}$  heterojunctions are efficient light harvesting photocatalysts.

### Carrier mobility

The carrier mobility was investigated to further evaluate the photocatalytic performance of the heterojunctions. Generally, high carrier mobility could potentially improve the charge utilization for redox reactions before their recombination.<sup>25,52</sup> Two directions of  $x$  and  $y$  were investigated as shown in Fig. S6.†

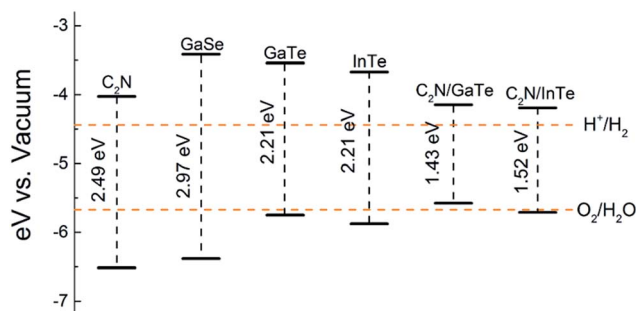

Fig. 3 Band edge positions of isolated monolayers and heterojunctions. The redox potentials of water splitting are represented by orange dashed lines.

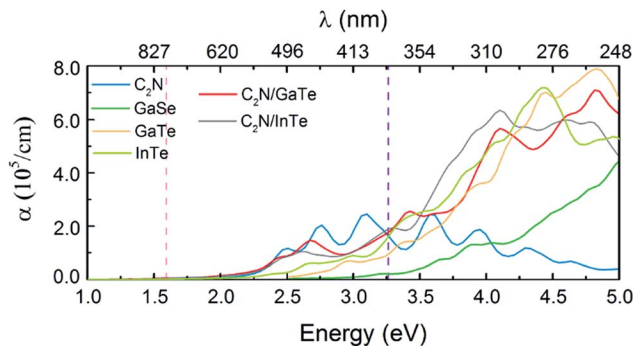

Fig. 4 Optical absorption coefficients for the isolated  $\text{C}_2\text{N}$ , GaSe, GaTe, and InTe monolayers as well as  $\text{C}_2\text{N}/\text{GaTe}$  and  $\text{C}_2\text{N}/\text{InTe}$  heterojunctions. The area between the red and the purple lines represents the visible-light range.

The effective masses of electrons ( $m_e^*$ ) and holes ( $m_h^*$ ) are computed by fitting parabolic functions to the CBM and VBM along the transport direction. The  $m_e^*$  and  $m_h^*$  along the directions of  $x$  and  $y$  for the isolated  $\text{C}_2\text{N}$ , GaTe and InTe monolayers as well as  $\text{C}_2\text{N}/\text{GaTe}$  and  $\text{C}_2\text{N}/\text{InTe}$  heterojunctions are shown in Tables S4† and 1. The  $m_h^*$  of the  $\text{C}_2\text{N}$  monolayer is much higher than the  $m_e^*$  of  $\text{C}_2\text{N}$ , indicating much lower hole mobility in the  $\text{C}_2\text{N}$  monolayer, consistent with previous reports.<sup>25</sup> For GaTe and InTe, the  $m_h^*$  is also larger than  $m_e^*$ , which agrees well with previously reported data,<sup>53,54</sup> indicating the credibility of our results.

To calculate the in-plane stiffness and DP constant, the relative energy and band edge positions of the CBM and VBM as a function of the uniaxial strain along the transport directions are shown in Fig. 5 and S7,† respectively. Based on the calculated effective masses, in-plane stiffness and DP constant, the carrier mobility of the isolated monolayers and heterojunctions could be obtained and are shown in Tables S4† and 1. In heterojunctions, the electron and hole mobility can become very high, which could be attributed to the improved in-plane stiffness and more dispersed valence band. The carrier mobility of  $\text{C}_2\text{N}/\text{GaTe}$  and  $\text{C}_2\text{N}/\text{InTe}$  is higher than that of many 2D semiconductors, such as  $\text{MoS}_2$  (ref. 38) and BN monolayers,<sup>55</sup> and comparable to that of MXenes<sup>39</sup> and phosphorene.<sup>56</sup> The improved carrier mobility indicates that the transfer of carriers

Table 1 Effective mass  $|m^*|$  ( $m_e$ , mass of free electrons), in-plane stiffness  $C$  ( $\text{N m}^{-1}$ ), DP constant  $|E_1|$  (eV) and carrier mobility  $\mu_{2D}$  ( $\text{cm}^2 \text{ V}^{-1} \text{ s}^{-1}$ ) for electrons and holes for  $\text{C}_2\text{N}/\text{GaTe}$  and  $\text{C}_2\text{N}/\text{InTe}$  heterojunctions along the directions of  $x$  and  $y$ , respectively

		$ m^* $	$C$	$ E_1 $	$\mu_{2D}$
$\text{C}_2\text{N}/\text{GaTe}$	$e_x$	0.82	222.11	2.60	685.67
	$h_x$	1.06	222.11	1.55	1163.21
	$e_y$	0.38	219.03	2.55	3229.29
	$h_y$	0.86	219.03	1.82	1251.53
	$e_z$	0.39	207.12	3.35	1744.56
$\text{C}_2\text{N}/\text{InTe}$	$e_x$	0.39	207.12	3.35	1744.56
	$h_x$	0.24	207.12	8.84	613.05
	$e_y$	0.42	207.04	3.54	1330.34
	$h_y$	0.31	207.04	8.88	390.98
	$e_z$	0.31	207.04	8.88	390.98



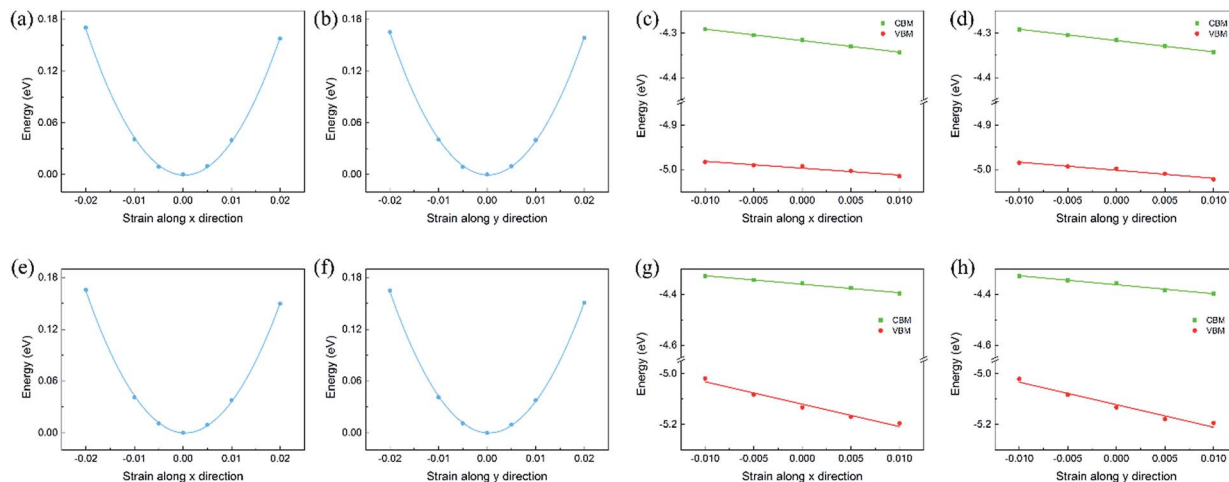

Fig. 5 The relationship between energy and strain for (a, b)  $C_2N/GaTe$  and (e, f)  $C_2N/InTe$ . The CBM and VBM along the x and y directions as a function of deformation proportion for (c, d)  $C_2N/GaTe$  and (g, h)  $C_2N/InTe$ .

to reactive sites is easier during the photocatalytic process. Besides, due to the short distance for the photogenerated electrons and holes to migrate in 2D nanosheets, the recombination of photogenerated carriers is further reduced. Therefore, it can be inferred that the photocatalytic activity of the  $C_2N/MX$  heterojunctions would be very good.

To further evaluate the separation of the charge carrier, the exciton binding energies ( $E_b$ ) were also calculated as shown in Table S5.† The  $E_b$  of  $C_2N$  was calculated to be 1.24 eV, which is consistent with those in previous reports.<sup>25,57</sup>  $C_2N/GaTe$  and  $C_2N/InTe$  exhibit much lower  $E_b$  values of 0.31 and 0.13 eV, respectively, indicating easier separation of carriers.

### HER and OER catalytic activity

The HER and OER catalytic activity is critically important for overall water splitting photocatalysts. The HER performance was evaluated from  $\Delta G_H$ , which was widely used in previous reports.<sup>58–61</sup> The OER catalytic activity was checked by using the free energy change of each step.<sup>62–65</sup>

Since the CBM of  $C_2N/GaTe$  and  $C_2N/InTe$  heterojunctions is mainly contributed by  $C_2N$  while the VBM mostly comes from the MX, the HER performance of the  $C_2N$  layer and the OER catalytic activity of the MX layer were calculated. The  $\Delta G_H$  with different hydrogen coverages on the  $C_2N$  layer is shown in Fig. 6.

The  $\Delta G_H$  of the first two hydrogen atoms is too negative, indicating that the bonding is too strong. The  $\Delta G_H$  of the third hydrogen could reach 0.08 and 0.03 eV for  $C_2N/GaTe$  and  $C_2N/InTe$ , respectively, which are very close to zero, implying that  $C_2N/GaTe$  and  $C_2N/InTe$  are potentially excellent catalysts for the HER at an appropriate H coverage. The fourth hydrogen atom adsorbed on the  $C_2N/GaTe$  and  $C_2N/InTe$  heterojunctions would be close to the MX layer (Fig. S8†), leading to a positive  $\Delta G_H$ .

Then the OER performance of MX in the heterojunctions was investigated. In order to calculate the limiting step of the OER, the free energy of each elementary step ( $\Delta G_1 - \Delta G_4$ ) was computed. The free energy diagrams of OER elementary steps on MX layers are shown in Fig. 7.

For both  $C_2N/GaTe$  and  $C_2N/InTe$  heterojunctions,  $\Delta G$  of the first three steps is positive while the last step is negative. The third step is the rate-limiting step with a  $\Delta G$  of 2.70 and 2.17 eV for  $C_2N/GaTe$  and  $C_2N/InTe$ , respectively. At the standard reduction potential of water oxidation (1.23 eV), the  $\Delta G$  of the rate-limiting step will decrease to 0.94 eV for  $C_2N/InTe$ , which is comparable to and even lower than that of many TM@C catalysts or metal oxides.<sup>66</sup>

The stability of  $C_2N$  in water has been experimentally confirmed<sup>24</sup> while the MX has been proven to be stable by calculating their enthalpy of solvation.<sup>26</sup> Therefore, the  $C_2N/MX$  heterojunctions would be stable in water. Overall, both  $C_2N/GaTe$  and  $C_2N/InTe$  are type-II heterojunctions with strong absorption in both visible and near ultraviolet regions and high carrier mobility. Especially,  $C_2N/InTe$  is a direct-band-gap heterojunction and exhibits excellent catalytic performance

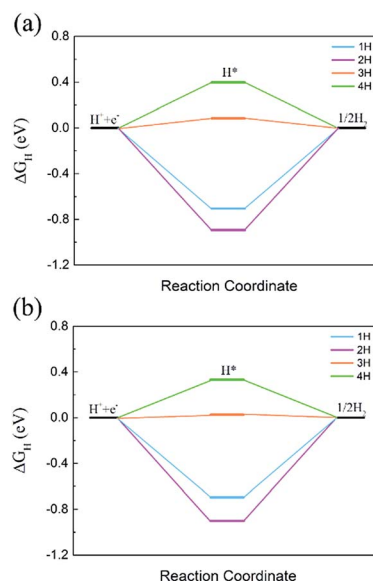

Fig. 6  $\Delta G_H$  with different hydrogen coverages on the  $C_2N$  layer in (a)  $C_2N/GaTe$  and (b)  $C_2N/InTe$  heterojunctions.



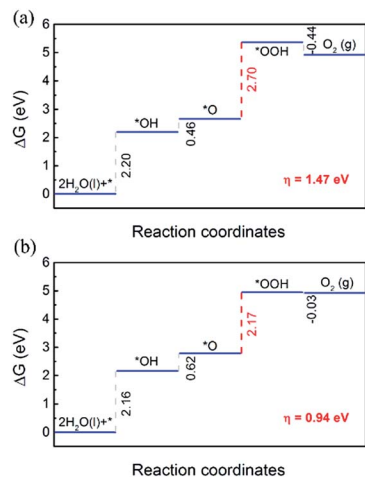

Fig. 7 Free energy diagram for the OER on MX in (a)  $C_2N/GaTe$  and (b)  $C_2N/InTe$ .

towards both the HER and the OER, indicating that it is a very promising photocatalyst for overall water splitting.

## Conclusions

In conclusion, based on band edge positions and lattice parameters, we found that several kinds of MX monolayers can be used to fabricate type-II heterojunctions with  $C_2N$  monolayers. By means of first-principles computations, we systematically investigated the photocatalytic performance of  $C_2N/GaTe$  and  $C_2N/InTe$  heterojunctions for overall water splitting. The results indicate that both are type-II heterojunctions, promoting the efficient spatial separation of electron-hole pairs; therefore, overcoming the electron-hole recombination issue. Interestingly, the  $C_2N/InTe$  heterojunction exhibits a direct band gap. The band edge positions from the HSE06 functional predict that their band edges straddle water redox potentials, satisfying the requirements for photocatalytic water splitting. Besides,  $C_2N/GaTe$  and  $C_2N/InTe$  heterojunctions exhibit strong absorption in both visible and near ultraviolet regions. The calculations of carrier mobility illustrate that the heterojunctions possess higher carrier mobility compared with isolated monolayers, indicating that the transfer of charge carriers to the reactive sites is easier, reducing the probability of recombination of photogenerated carriers. The  $\Delta G_H$  can reach 0.08 and 0.03 eV for  $C_2N/GaTe$  and  $C_2N/InTe$  heterojunctions, respectively, leading to a high HER catalytic activity. Moreover, the  $C_2N/InTe$  heterojunction possesses a good OER catalytic performance. These results indicate that  $C_2N/GaTe$  and  $C_2N/InTe$  heterojunctions, especially  $C_2N/InTe$ , are very promising photocatalysts for water splitting. Our findings could be helpful to rationally design more type-II heterojunctions for photocatalytic water splitting.

## Conflicts of interest

There are no conflicts to declare.

## Acknowledgements

This work was supported by the National Natural Science Foundation of China (21421001). The computations were performed on the Magic Cube at the Shanghai Supercomputer Center.

## Notes and references

- X. Chen, S. Shen, L. Guo and S. S. Mao, *Chem. Rev.*, 2010, **110**, 6503–6570.
- S. Y. Reece, J. A. Hamel, K. Sung, T. D. Jarvi, A. J. Esswein, J. J. H. Pijpers and D. G. Nocera, *Science*, 2011, **334**, 645–648.
- A. Fujishima and K. Honda, *Nature*, 1972, **238**, 37–38.
- A. Kudo and Y. Miseki, *Chem. Soc. Rev.*, 2009, **38**, 253–278.
- Y. Tachibana, L. Vayssieres and J. R. Durrant, *Nat. Photonics*, 2012, **6**, 511–518.
- J. Yang, D. Wang, H. Han and C. Li, *Acc. Chem. Res.*, 2013, **46**, 1900–1909.
- M. Z. Rahman, K. Davey and S.-Z. Qiao, *J. Mater. Chem. A*, 2018, **6**, 1305–1322.
- J. Ran, W. Guo, H. Wang, B. Zhu, J. Yu and S. Z. Qiao, *Adv. Mater.*, 2018, **30**, 1800128.
- J. Ran, B. Zhu and S. Z. Qiao, *Angew. Chem., Int. Ed.*, 2017, **56**, 10373–10377.
- J. Ran, G. Gao, F.-T. Li, T.-Y. Ma, A. Du and S.-Z. Qiao, *Nat. Commun.*, 2017, **8**, 13907.
- A. K. Singh, K. Mathew, H. L. Zhuang and R. G. Hennig, *J. Phys. Chem. Lett.*, 2015, **6**, 1087–1098.
- X. Zhang, X. Zhao, D. Wu, Y. Jing and Z. Zhou, *Adv. Sci.*, 2016, **3**, 1600062.
- M. Zhou, X. W. Lou and Y. Xie, *Nano Today*, 2013, **8**, 598–618.
- D. Wu, X. Zhang, Y. Jing, X. Zhao and Z. Zhou, *Nano Energy*, 2016, **28**, 390–396.
- X. Zhang, Z. Zhang, D. Wu, X. Zhang, X. Zhao and Z. Zhou, *Small Methods*, 2018, **2**, 1700359.
- X. Zhang, Z. Zhang, X. Zhao, D. Wu, X. Zhang and Z. Zhou, *J. Mater. Chem. A*, 2017, **5**, 2870–2875.
- X. Wang, K. Maeda, A. Thomas, K. Takane, G. Xin, J. M. Carlsson, K. Domen and M. Antonietti, *Nat. Mater.*, 2009, **8**, 76–80.
- T. A. Shifa, F. Wang, Z. Cheng, P. He, Y. Liu, C. Jiang, Z. Wang and J. He, *Adv. Funct. Mater.*, 2018, **28**, 1800548.
- Z. Cheng, T. A. Shifa, F. Wang, Y. Gao, P. He, K. Zhang, C. Jiang, Q. Liu and J. He, *Adv. Mater.*, 2018, 1707433.
- H. Wang, L. Zhang, Z. Chen, J. Hu, S. Li, Z. Wang, J. Liu and X. Wang, *Chem. Soc. Rev.*, 2014, **43**, 5234–5244.
- S. J. A. Moniz, S. A. Shevlin, D. J. Martin, Z.-X. Guo and J. Tang, *Energy Environ. Sci.*, 2015, **8**, 731–759.
- J. Mahmood, E. K. Lee, M. Jung, D. Shin, I. Y. Jeon, S. M. Jung, H. J. Choi, J. M. Seo, S. Y. Bae, S. D. Sohn, N. Park, J. H. Oh, H. J. Shin and J. B. Baek, *Nat. Commun.*, 2015, **6**, 6486.
- M. R. A. Kishore and P. Ravindran, *ChemPhysChem*, 2017, **18**, 1526–1532.
- L. Wang, X. Zheng, L. Chen, Y. Xiong and H. Xu, *Angew. Chem., Int. Ed.*, 2018, **57**, 3454–3458.



- 25 R. Kumar, D. Das and A. K. Singh, *J. Catal.*, 2018, **359**, 143–150.
- 26 H. L. Zhuang and R. G. Hennig, *Chem. Mater.*, 2013, **25**, 3232–3238.
- 27 G. Kresse and J. Furthmüller, *Phys. Rev. B: Condens. Matter Mater. Phys.*, 1996, **54**, 11169–11186.
- 28 G. Kresse and D. Joubert, *Phys. Rev. B: Condens. Matter Mater. Phys.*, 1999, **59**, 1758–1775.
- 29 J. P. Perdew, K. Burke and M. Ernzerhof, *Phys. Rev. Lett.*, 1996, **77**, 3865–3868.
- 30 S. Grimme, J. Antony, S. Ehrlich and H. Krieg, *J. Chem. Phys.*, 2010, **132**, 154104.
- 31 S. Grimme, S. Ehrlich and L. Goerigk, *J. Comput. Chem.*, 2011, **32**, 1456–1465.
- 32 H. J. Monkhorst and J. D. Pack, *Phys. Rev. B: Solid State*, 1976, **13**, 5188–5192.
- 33 S. Kümmel and L. Kronik, *Rev. Mod. Phys.*, 2008, **80**, 3–60.
- 34 J. Heyd, G. E. Scuseria and M. Ernzerhof, *J. Chem. Phys.*, 2003, **118**, 8207–8215.
- 35 J. Bardeen and W. Shockley, *Phys. Rev.*, 1950, **80**, 72–80.
- 36 M.-Q. Long, L. Tang, D. Wang, L. Wang and Z. Shuai, *J. Am. Chem. Soc.*, 2009, **131**, 17728–17729.
- 37 J. Qiao, X. Kong, Z.-X. Hu, F. Yang and W. Ji, *Nat. Commun.*, 2014, **5**, 4475.
- 38 Y. Cai, G. Zhang and Y.-W. Zhang, *J. Am. Chem. Soc.*, 2014, **136**, 6269–6275.
- 39 X. Zhang, X. Zhao, D. Wu, Y. Jing and Z. Zhou, *Nanoscale*, 2015, **7**, 16020–16025.
- 40 Y. Jing, X. Zhang, D. Wu, X. Zhao and Z. Zhou, *J. Phys. Chem. Lett.*, 2015, **6**, 4252–4258.
- 41 M. Gajdoš, K. Hummer, G. Kresse, J. Furthmüller and F. Bechstedt, *Phys. Rev. B: Condens. Matter Mater. Phys.*, 2006, **73**, 045112.
- 42 H. H. Wu, Q. Meng, H. Huang, C. T. Liu and X. L. Wang, *Phys. Chem. Chem. Phys.*, 2018, **20**, 3608–3613.
- 43 S. Saha, T. P. Sinha and A. Mookerjee, *Phys. Rev. B: Condens. Matter Mater. Phys.*, 2000, **62**, 8828–8834.
- 44 J. K. Nørskov, J. Rossmeisl, A. Logadottir, L. Lindqvist, J. R. Kitchin, T. Bligaard and H. Jónsson, *J. Phys. Chem. B*, 2004, **108**, 17886–17892.
- 45 Y.-A. Zhu, D. Chen, X.-G. Zhou and W.-K. Yuan, *Catal. Today*, 2009, **148**, 260–267.
- 46 H. Wang, X. Li and J. Yang, *ChemPhysChem*, 2016, **17**, 2100–2104.
- 47 T. Björkman, A. Gulans, A. V. Krasheninnikov and R. M. Nieminen, *Phys. Rev. Lett.*, 2012, **108**, 235502.
- 48 Z. Liu, J. Z. Liu, Y. Cheng, Z. Li, L. Wang and Q. Zheng, *Phys. Rev. B: Condens. Matter Mater. Phys.*, 2012, **85**, 205418.
- 49 S. Chen, L. Zuzhang, Z. Jian and S. Zhimei, *2D Mater.*, 2017, **4**, 015027.
- 50 J. Wang, Z. Guan, J. Huang, Q. Li and J. Yang, *J. Mater. Chem. A*, 2014, **2**, 7960–7966.
- 51 W. Hu, L. Lin, R. Zhang, C. Yang and J. Yang, *J. Am. Chem. Soc.*, 2017, **139**, 15429–15436.
- 52 T. Luttrell, S. Halpegamage, J. Tao, A. Kramer, E. Sutter and M. Batzill, *Sci. Rep.*, 2014, **4**, 4043.
- 53 L. Huang, Z. Chen and J. Li, *RSC Adv.*, 2015, **5**, 5788–5794.
- 54 H. Jin, J. Li, Y. Dai and Y. Wei, *Phys. Chem. Chem. Phys.*, 2017, **19**, 4855–4860.
- 55 S. Bruzzone and G. Fiori, *Appl. Phys. Lett.*, 2011, **99**, 222108.
- 56 J. Qiao, X. Kong, Z. X. Hu, F. Yang and W. Ji, *Nat. Commun.*, 2014, **5**, 4475.
- 57 J. Sun, R. Zhang, X. Li and J. Yang, *Appl. Phys. Lett.*, 2016, **109**, 133108.
- 58 C. Ling, L. Shi, Y. Ouyang and J. Wang, *Chem. Mater.*, 2016, **28**, 9026–9032.
- 59 G. Gao, A. P. O'Mullane and A. Du, *ACS Catal.*, 2017, **7**, 494–500.
- 60 G. Gao, S. Bottle and A. Du, *Catal. Sci. Technol.*, 2018, **8**, 996–1001.
- 61 X. Zhang, A. Chen, Z. Zhang, M. Jiao and Z. Zhou, *J. Mater. Chem. A*, 2018, **6**, 11446–11452.
- 62 M. Li, L. Zhang, Q. Xu, J. Niu and Z. Xia, *J. Catal.*, 2014, **314**, 66–72.
- 63 C. Ling, L. Shi, Y. Ouyang, X. C. Zeng and J. Wang, *Nano Lett.*, 2017, **17**, 5133–5139.
- 64 G. Gao, E. R. Waclawik and A. Du, *J. Catal.*, 2017, **352**, 579–585.
- 65 Y.-N. Chen, X. Zhang, H. Cui, X. Zhang, Z. Xie, X.-G. Wang, M. Jiao and Z. Zhou, *Energy Storage Materials*, 2018, **15**, 226–233.
- 66 X. Cui, P. Ren, D. Deng, J. Deng and X. Bao, *Energy Environ. Sci.*, 2016, **9**, 123–129.

