

Recent developments in palladium catalysed carbonylation reactions

Cite this: *RSC Adv.*, 2014, 4, 10367

Sandip T. Gadge and Bhalchandra M. Bhanage*

Recently, carbonylation reactions have gained considerable interest as they are becoming a versatile tool in the synthesis of pharmaceuticals, agrochemicals and their intermediates. Nowadays, a plethora of transition metal catalysts are available for the synthesis of various functional groups like ureas, carbamates, oxamates, oxamides, α -keto amides, ketones, esters, etc. using carbonylation methodology. Several carbonylation reactions such as aminocarbonylation, alkoxy carbonylation, double carbonylation and oxidative carbonylation, provide efficient and attractive alternatives to the conventional synthetic routes on a laboratory or industrial scale. Oxidative carbonylation is an important reaction as it allows direct carbonylative C–H bond activation. A double carbonylation reaction provides a one step alternative route for the synthesis of α -keto amides, oxamides, and oxamates. It also eliminates the use of conventional thermally unstable and toxic reagents like oxalyl chloride. Several recent studies have focused on the various aspects of these reactions, including catalyst–product separation, and catalyst recoverability and reusability. In view of this, developments in anchoring homogeneous catalysts using various techniques like biphasic catalysis and supported liquid phase catalysis are gaining importance. Carbonylation routes using these techniques are simple, efficient, economical, avoid the use of ligands, and give the desired products in excellent yields. The use of phosphine ligands is disadvantageous as it leads to air/moisture sensitivity, tedious work-up procedures and high work-up costs. Several phosphine-free carbonylation routes eliminate the use of phosphine ligands, and provide economical and simple methods for these transformations. In this review we have summarized the recent trends in carbonylative transformations, which have undergone a rapid development.

Received 30th October 2013
Accepted 19th December 2013

DOI: 10.1039/c3ra46273k

www.rsc.org/advances

Department of Chemistry, Institute of Chemical Technology, N. Parekh Marg, Matunga, Mumbai-400019, India. E-mail: bm.bhanage@gmail.com; bm.bhanage@ictmumbai.edu.in; Tel: +91 22-33612601

1. Introduction

The development of sustainable and efficient methodologies based on catalysis and organometallic chemistry has gained



Sandip T. Gadge completed his M.Sc. degree in Organic Chemistry from the Department of Chemistry, University of Pune in 2009. After working as a project assistant at IISER Pune for a few months, he moved to the Institute of Chemical Technology (formerly UDCT), Mumbai in 2011 to begin his Ph.D. programme under the supervision of Prof. Bhalchandra M. Bhanage. His Ph.D. research focuses on

the development of advanced methodologies for carbonylation reactions such as oxidative carbonylation, double carbonylation reactions, alkoxy carbonylation and aminocarbonylation reactions of alkynes and aryl halides.



Bhalchandra M. Bhanage obtained his doctorate from Pune University in 1996. He spent more than one year at Tohoku University, Japan (1997–1998), and four years at Hokkaido University, Japan (2000–2003) as a post-doctoral fellow with Prof. M. Arai. In 2004, he joined the Institute of Chemical Technology, Mumbai, India as a Professor of Industrial and Engineering chemistry. Among his current interests is catalysis

using CO₂, CO and H₂. He has worked on developing novel catalysts for various coupling reactions, carbonylation reactions, hydroformylation reactions, amination reactions, etc. He is also working on nano-materials, enzymatic catalysis and the use of non-conventional techniques like ultrasound and microwaves for various reactions.

considerable attention. In this context, palladium catalysed carbonylation reactions are now widely recognized as a very important tool in industrial and organic chemistry. Palladium catalysed carbonylation chemistry allows the direct synthesis of carbonyl compounds using readily available feed stocks such as carbon monoxide (CO), which is also the simplest C-1 unit and meets the requirements of “atom economy”,¹ step economy² and “green chemistry”.³ The significance of palladium catalyzed cross coupling reactions has been recognized by awarding the 2010 Nobel Prize in chemistry to Professors Heck, Negishi, and Suzuki. Nowadays, a variety of transition metal catalysts are available for the synthesis of ureas, carbamates, oxazolidinones, oxamates, oxamides, α -keto amides, ketones, esters, amides, *etc.* These are important intermediates in the manufacture of dyes, pharmaceuticals, agrochemicals, and other industrial products. Various homogeneous transition metals can catalyse single or double carbonylation reactions, and oxidative carbonylation methodologies have been developed for the synthesis of these compounds. Palladium catalyzed oxidative carbonylation reactions require the coupling of organic nucleophiles or electrophiles in the presence of CO and an oxidant to prepare various carbonyl-containing compounds.⁴ The double carbonylation methodology provides an efficient way to synthesise oxamates, oxamides and α -keto amides, which were traditionally synthesised by multi-step syntheses using thermally unstable mono esters of oxalyl chlorides. The synthesis of mono esters of oxalyl chlorides requires the combination of equimolar quantities of oxalyl chloride and the appropriate alcohol, along with a distillation setup for the isolation of the product from the reaction mixture. This is a major drawback of this method.⁵ Hence, the double carbonylation methodology provides an efficient alternative for the synthesis of these industrially valuable products.

Today, catalyst–product separation techniques, catalyst recoverability and catalyst reusability are the central issues to achieve an economical and environmentally friendly approach from sustainable and industrial viewpoints. Several techniques, such as biphasic catalysis,⁶ supported metal catalysis, polymer anchored catalysis and metal leaching re-deposition, have been developed in recent years.⁷ The catalysts can be easily separated, repeatedly used and, consequently, these methods provide an efficient and economical way to perform carbonylative coupling reactions. Such catalysts avoid the use of phosphines and because of this they are not air sensitive and they show moisture stability. They afford the coupling products in high yields at short reaction times. There are several reviews contributing to the area of homogeneous transition metal catalysed carbonylation reactions.^{4a,b,8} In this review we have described the recent developments in carbonylative transformations considering all these aspects.

2. Heterogeneous palladium-catalysed oxidative carbonylation reactions

Palladium catalysed oxidative carbonylation reactions lead to carbonylated derivatives *via* coupling of two nucleophiles with

the assistance of a suitable oxidant. The oxidant helps to oxidize the metal $M(n)$ to $M(n + 2)$, which promotes the catalytic cycle.⁴ The syntheses of urea, carbamate and oxazolidinone derivatives through the palladium catalysed oxidative carbonylation of amines and amino alcohols have been reported in several studies. Traditional synthetic methods for the synthesis of ureas use toxic and corrosive reagents, such as phosgene or isocyanates. In a typical oxidative carbonylation reaction, alcohols and amines are used as starting materials along with molecular oxygen as an oxidant in the presence of a homogeneous palladium catalyst.⁹ This leads to the synthesis of ureas, carbamates and oxazolidinones, and these procedures are simple and less wasteful. Later, several groups developed various palladium catalysed heterogeneous, phosphine-free protocols. They provided easy catalyst–product separation methods along with catalyst reusability and recyclability.

2.1 Heterogeneous palladium catalysed oxidative carbonylation reactions of amines for the synthesis of carbamates

Fukuoka and co-workers synthesised carbamates by the oxidative alkoxy carbonylation of amines in the presence of a platinum group metal M and an alkali metal halide or onium halide (Scheme 1).¹⁰ The reaction proceeds with various platinum group based heterogeneous catalysts and the catalyst could be recovered and reused twenty times showing excellent selectivity, yield and robustness.

The reaction mechanism (Scheme 2) describes the oxidative addition of amine **1** to catalyst M to produce the active amino–metal species **4**. The species **4** undergoes insertion of CO to produce the carbamoyl–metal species **5**. The carbamate **2** was considered to be formed by two pathways, **a** and **b**. Pathway **a** shows the formation of the metal hydride species **6** by the attack of intermediate **5** by the alcohol. Pathway **b** shows the formation of urea **3** and metal hydride species **6**. Further species **3** oxidatively adds to M to generate aminocarbamoyl metal species **7**, which is further attacked by the alcohol to produce **2** and regenerate the active species **4**.

In 1992, Chaudhari and co-workers studied the oxidative carbonylation of methyl amine for the synthesis of methyl *N*-methylcarbamate (MMC) using a palladium on carbon (Pd/C) catalyst (Scheme 3).¹¹ The effect of various reaction parameters such as the effect of iodide promoters, the ratio of Pd : NaI, the CO : O₂ ratio, the catalyst concentration, the temperature and the effect of methyl amine concentration has been studied in detail. It was observed that at lower temperatures and higher methyl amine concentrations, *N,N*-dimethylurea (DMU) was obtained as the major product. At higher temperatures and lower methyl amine concentrations, MMC was formed as the



Scheme 1 Reagents and conditions: aniline (50 mmol), EtOH (50 mL), M [Pd black (0.3 mg–atom)], NaI (0.6 mmol), CO (80 kg cm⁻²), O₂ (6 kg cm⁻²), temp. 160–170 °C, time 2 h.

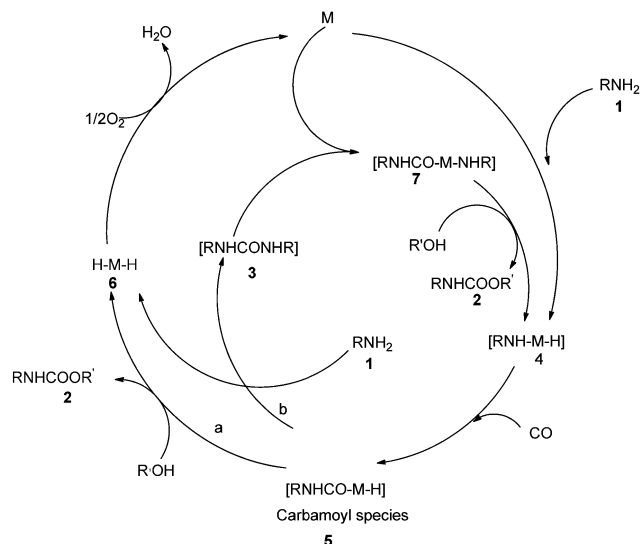

Scheme 2 Proposed reaction mechanism for the carbamate synthesis by oxidative carbonylation of amines.

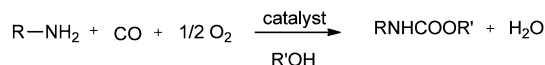

Scheme 3 Reagents and conditions: amine ($1.0 \times 10^{-3} \text{ mol cm}^{-3}$), Pd catalyst ($2.35 \times 10^{-6} \text{ mol cm}^{-3}$), NaI ($2.30 \times 10^{-6} \text{ mol cm}^{-3}$), solvent CH_3OH , temp. 443 K, $\text{CO} : \text{O}_2$ pressure 61 atm ($\text{CO} : \text{O}_2$ 13 : 1), time 120 min.

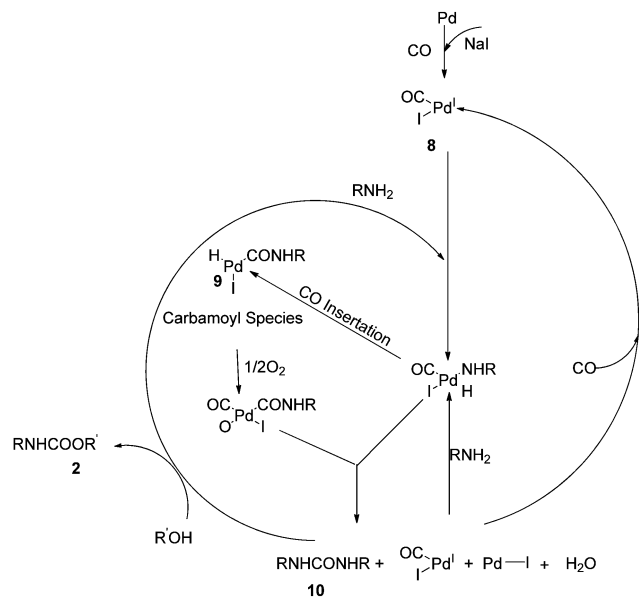

Scheme 4 Proposed mechanism for the oxidative carbonylation of amines to carbamates.

major product. At higher $\text{CO} : \text{O}_2$ ratios, *N*-methylformamide (NMF) was the major product.

Based on these observations they proposed a reaction mechanism for carbamate synthesis (Scheme 4). DMU was



Fig. 1 Proposed mechanism for carbamate synthesis from the oxidative carbonylation over NaI-Pd/C.



Fig. 2 The oxidative carbonylation of aniline to carbamate using a $\text{Pd}(\text{phen})\text{Cl}_2/(\text{BMIm})\text{BF}_4$ catalytic system.



Scheme 5 Reagents and conditions: aniline (53.8 mmol), catalyst 5% Pd/C ($5.0 \times 10^{-3} \text{ g cm}^{-3}$), NaI (0.87 mmol), DMF (95 cm^3), $\text{CO} : \text{O}_2$ pressure (41 bar) ($\text{CO} : \text{O}_2$, 5 : 1), temp. 100°C , time 2 h.

found to be an intermediate product in the MMC synthesis. Fukuoka *et al.* proposed the Pd-carbamoyl complex intermediate 5 (ref. 10) but failed to explain the role of iodide promoters. In this mechanism, the role of the iodide promoters was clearly understood. In the absence of NaI, the reaction does not proceed, indicating Pd^0 state. In the presence of iodide and oxygen, the active catalyst species 8 was observed. The formation of 2 occurs in two steps through *N,N'*-diarylurea 10 as an intermediate.

Chuang and Toochinda reported the synthesis of carbamates using a NaI-Pd/C catalytic system in slurry, gas-solid and tubular reactors.¹² The oxidative carbonylation over NaI-Pd/C in a gas-solid fixed-bed reactor could provide an effective pathway for carbamate syntheses and allowed easy catalyst recovery. Atomic absorption analysis of the reactant-product mixture

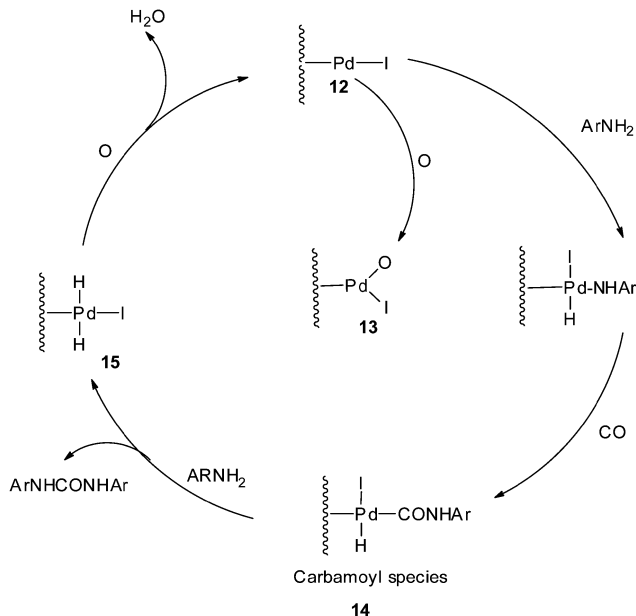

Scheme 6 Proposed mechanism for the Pd/C catalysed oxidative carbonylation of aniline to diphenylurea.

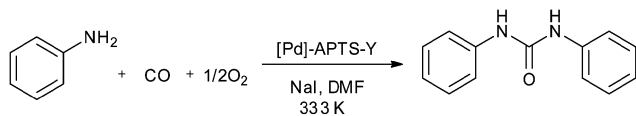

Scheme 7 Reagents and conditions: amine 0.80 kmol m^{-3} , [Pd]-APTS-Y (1.854 kg m^{-3}), NaI ($1.24 \times 10^{-3} \text{ kmol m}^{-3}$), pressure (CO : O₂) 50 psi, DMF, time 8 h, temp. 333 K.

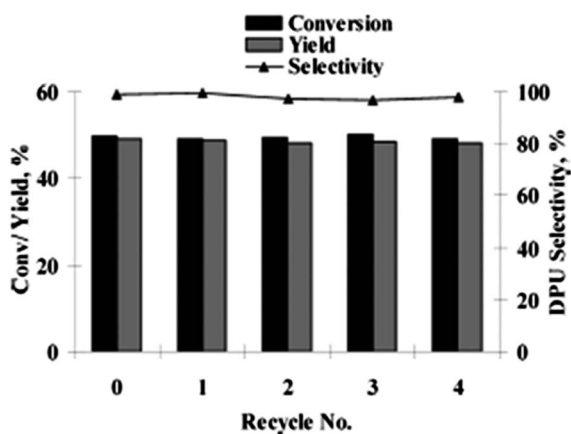

Fig. 3 Recyclability studies of the [Pd]-APTS-Y catalyst for the oxidative carbonylation of aniline. Reagents and conditions: aniline (0.82 kmol m^{-3}), [Pd]-APTS-Y (1.854 kg m^{-3}), NaI ($1.24 \times 10^{-3} \text{ kmol m}^{-3}$), pressure (CO : O₂) 50 psi, temp. 333 K, DMF, time 4 h.

showed that there was no Pd loss from the carbon surface. The proposed mechanism is based on the previous studies by the Fukuoka and Chaudhari group (Fig. 1).

Deng and co-workers synthesised carbamates by the oxidative carbonylation of aniline with CO, O₂ and methanol in the



Scheme 8 Reagents and conditions: amine (2 mL) (liquid substrate) or 1.5 g (solid substrate), (Pd/ZrO₂-SO₄²⁻) 35 mg, CH₃CN (15 mL), CO (3.5 MPa), O₂ (0.5 MPa), temperature 135 °C, time 1 h. (Unsymmetrical ureas synthesised by directly using aniline as a solvent in the presence of aliphatic amines.)

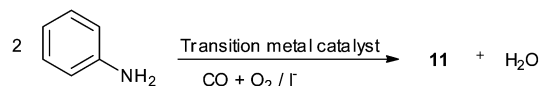

Scheme 9 Reagents and conditions: amine (74 mmol), Pd(OAc)₂(BipyDS) (0.078 mmol), water (10 mL), toluene (50 mL), NaI (0.90 mmol), pressure (68.9 bar), CO : O₂ (13 : 1), agitation (16.66 Hz), temp. 423 K, time 2 h.

presence of a Pd(phen)Cl₂/(BmImBF₄) catalytic system.¹³ The products could be precipitated by adding water into the resulting mixture and the catalyst system could be reused. The resulting catalyst was soluble in the water phase and could be easily recycled (Fig. 2). Step I consists of the oxidative carbonylation of aniline with CO, O₂ and methanol in the presence of the Pd(phen)Cl₂/(BmImBF₄) catalyst. A liquid mixture containing the desired product was obtained after the reaction. Step II involves the addition of 10 mL of water into the reaction mixture, which leads to the precipitation of the product. In step III the solid product is recovered. An ionic liquid containing Pd(phen)Cl₂ could also be recovered and reused in step IV after the filtrate was distilled to remove the water.

2.2 Heterogeneous palladium catalysed oxidative carbonylation reactions of amines for the synthesis of ureas

Gupte and Chaudhari synthesised *N,N'*-diphenylurea (DPU) **11** by the oxidative carbonylation of aniline over a 5% Pd/C-NaI catalyst system (Scheme 5).^{11,14} The effects of promoters, solvents, reaction conditions, CO : O₂ pressure, and pre-treatment of the catalyst with reactants have been investigated in detail. The optimum NaI/Pd ratio (molar) observed was 3.6. At higher concentrations of iodide promoters, catalyst inhibition takes place due to the strong adsorption properties of NaI, leaving behind smaller sites vacant for adsorption of CO and O₂. The Pd/C-NaI catalyst system could also be reused several times without loss of activity.

The proposed mechanism (Scheme 6) shows that the reaction proceeds through the Pd-carbamoyl complex **14** as described by Fukuoka *et al.*¹⁰ In the absence of iodide promoters, the reaction does not take place. In the presence of NaI, the Pd/C is modified to **12** as an active species, as proposed in Scheme 6. At a higher O₂ pressure the active site may be species **13**, which is inactive for oxidative carbonylation reactions, indicating inhibition of the catalyst by blocking the sites on the carbon support. The pre-treatment results also showed that there was a significant decrease in the catalytic activity at higher oxygen pressures. The carbamoyl intermediate **14** is



Scheme 10 Proposed mechanism for urea synthesis in a biphasic system.



Scheme 11 Reagents and conditions: ethanolamine (10 mmol), Pd/C (0.01 mmol), promoter (0.036 mmol), temp. 100 °C, CO (1.0 MPa), O₂ (0.25 MPa), DME (8 mL), time 1 h.



Scheme 14 Reagents and conditions: DMA (0.5 mmol of diol/mL of DMA, 4 mmol scale based on diol), KI/PdI₂ molar ratio of 10, CO (20 atm, 4 : 1 CO/air mixture), temp. 100 °C.

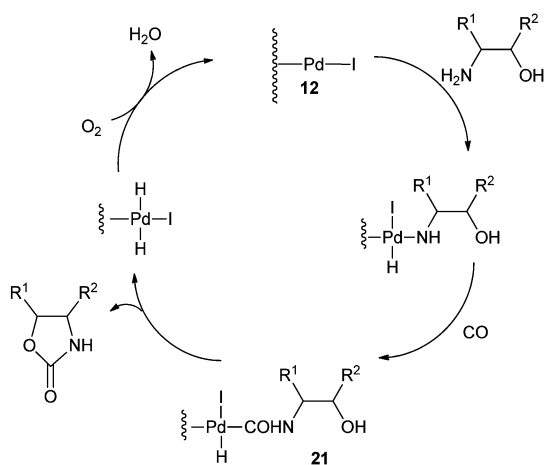

Scheme 12 Proposed mechanism for the oxazolidinone synthesis by the Pd/C catalysed oxidative carbonylation reaction.

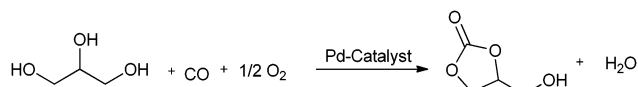

Scheme 15 Oxidative carbonylation of glycerol to glycerol carbonate using a Pd-catalyst.

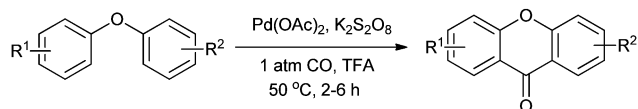

Scheme 16 Reagents and conditions: diaryl ether (0.2 mmol), Pd(OAc)₂ (2.5 mol%), K₂S₂O₈ (2 equiv.), 1 atm CO, TFA (1.0 mL), temp. 50 °C, time 2–6 h.

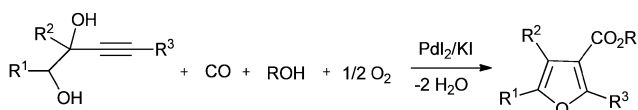

Scheme 13 Reagents and conditions: alcohol (0.05 mmol of 3-yne-1,2-diol per mL of alcohol), PdI₂ (2 mol%), KI (KI/PdI₂ molar ratio of 5), CO [40 atm (4/1 mixture of CO and air)], temp. 100 °C, time 2 h.

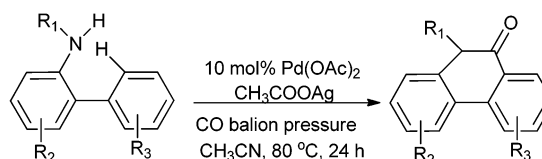

Scheme 17 Reagents and conditions: *N*-sulfonyl-2-aminobiaryls (50.0 mg), Pd(OAc)₂ (10 mol%), CH₃COOAg (5 equiv.), 4 mL of anhydrous CH₃CN, CO balloon, temp. 80 °C, time 24 h.



Scheme 18 Reagents and conditions: indole (0.2 mmol), PdCl₂(PPh₃)₂ (2.5 mol%), PPh₃ (5 mol%), Cu(OAc)₂ (10 mol%), 1 atm CO/air (7 : 1), *n*BuOH (0.2 mL), toluene/DMSO (1.5 mL/0.1 mL), temp. 100 °C, time 36 h.



Scheme 19 Reagents and Conditions: indole (0.2 mmol), PdCl₂(PPh₃)₂ (2.5 mol%), PPh₃ (5 mol%), Cu(OAc)₂ (10 mol%), 1 atm CO/air (7 : 1), *n*BuOH (0.2 mL), toluene/DMSO (1.5 mL/0.1 mL), temp. 100 °C, time 36 h.



Scheme 20 Reagents and conditions: benzothiophene (0.2 mmol), PdCl₂(PPh₃)₂ (2.5 mol%), PPh₃ (5 mol%), Cu(OAc)₂ (10 mol%), 1 atm CO/air (7 : 1), alcohol (0.2 mL), toluene/DMSO (1.5 mL/0.1 mL), temp. 90 °C, time 36 h.



Scheme 21 Reagents and conditions: ArB(OH)₂ (1 mmol), styrene (1 mmol), DMSO (2 mL), Pd(OAc)₂ (2 mol%), DPPP (2 mol%), air (5 bar), CO (5 bar), temp. 60 °C, time 20 h.

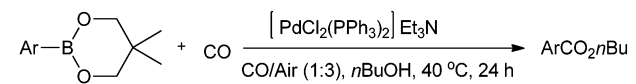

Scheme 22 Reagents and conditions: arylboronic acid (0.25 mmol), *n*BuOH (2 mL), Et₃N (0.5 mmol), [PdCl₂(PPh₃)₂] (0.0125 mmol), CO/air (1 : 3) at 1 atm pressure.

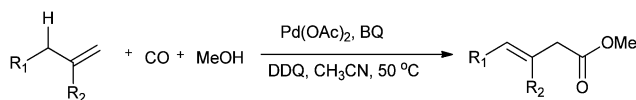

Scheme 23 Reagents and conditions: alkene (0.3 mmol), Pd(OAc)₂ (10 mol%), oxidant (BQ: 2 equiv.; DDQ: 0.5 equiv.), MeCN (2 mL), MeOH (0.5 mL), CO (1 atm), temp. 50 °C, time 24 h.

attacked by the amine to give the urea as a product and regenerate the metal hydride species **15**. The iodide promoter in the presence of oxygen plays a key role in regenerating the active catalyst by eliminating water as a by-product.

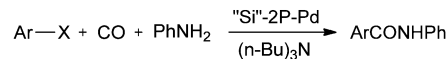

Scheme 24 Reagents and conditions: aryl halide (5 mmol), aniline (8 mmol), tri-*n*-butylamine (7 mmol), 'Si'-2P-Pd (180 mg, 0.075 mmol Pd), atmospheric pressure of CO.

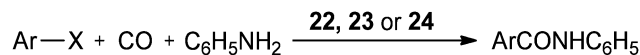

Scheme 25 Reagents and conditions: aryl halide (5 mmol), aniline (8 mmol), *n*-Bu₃N (7 mmol), CO (1 atm), **22** (0.08 mmol) or **23** (0.078 mmol) or **24** (0.08 mmol).

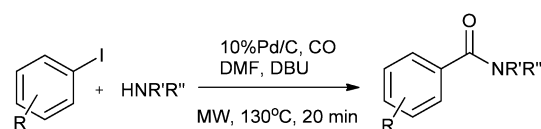

Scheme 26 Reagents and conditions: aryl iodide (0.50 mmol), amine (0.50 mmol), DMF (1 mL), DBU (224 μL, 1.50 mmol), Pd/C 10% (10 mg, 0.01 mmol), CO (130 psi), time 20 min, temp. 130 °C at 150 W.

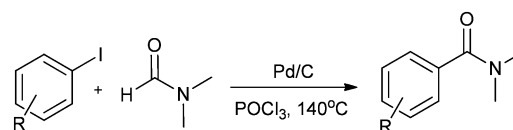

R = H, Me, OMe, Br, NO₂

Scheme 27 Reagents and conditions: aryl iodide (1 mmol), Pd/C (0.1 mmol), POCl₃ (2 mmol), DMF (10 mL), temp. 140 °C, time 24 h.



Scheme 28 Reagents and conditions: *o*-dihaloaryl/*o*-halobenzoate/*o*-halobenzoic acid (0.5 mmol), amine (0.7 mmol), 10% Pd/C (2.5 mol%), DABCO (1.5 mmol), toluene (7 mL), CO (90 psi), temp. 120 °C, time 2 h.

In 2010, Didgikar *et al.* reported palladium nanoparticles immobilized on a NaY zeolite support through 3-amino-propyl-trimethoxysilane (APTS) as an anchoring agent ([Pd]-APTS-Y). The [Pd]-APTS-Y catalyst along with NaI promoter showed excellent selectivity towards the desired urea products with a wide range of amine compounds (Scheme 7).¹⁵ The previously reported 5% Pd/C catalyst had a very poor TOF of 23.6 h⁻¹ compared to the [Pd]-APTS-Y catalyst (TOF of 157.5 h⁻¹). The [Pd]-APTS-Y catalyst had a high activity (TOF of 157 h⁻¹) even at lower temperatures and pressures compared to the catalysts reported previously. The catalyst was easily separated and recycled several times without any loss of activity (Fig. 3).¹⁵



Scheme 29 Reagents and conditions: *o*-halobenzoic acid (1 mmol), amine (1.5 mmol), **25** (1 mol%), Et₃N (2 mmol), toluene (10 mL), CO (1 atm), temp. 100 °C, time 4 h.

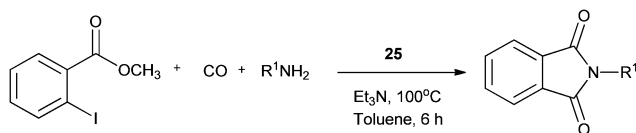

Scheme 30 Reagents and conditions: *o*-halobenzoate (1 mmol), amine (1.5 mmol), **25** (1 mol%), Et₃N (2 mmol), toluene (10 mL), CO (1 atm), temp. 100 °C, time 6 h.



Scheme 31 Reagents and conditions: aryl iodide (1 mmol), amine (2 mmol), Na₂CO₃ (2 mmol), **25** (50 mg, 14.2 μmol), water (10 mL), CO pressure (100 psi), temp. 100 °C, time 8 h.

Deng and co-workers reported a sulfate modified zirconia supported palladium catalyst (Pd/ZrO₂-SO₄²⁻) for the synthesis of disubstituted ureas by the oxidative carbonylation of a series of aliphatic amines (Scheme 8).¹⁶

The combination of aliphatic amines in aniline as a solvent led to various unsymmetrical ureas. The catalyst could be easily separated and recovered from the reaction mixture. Afterwards the same group developed a homogeneous catalyst system consisting of a palladium complex and an ionic liquid (Pd(phen)Cl₂/BMImBF₄)¹³ for the synthesis of ureas. The reaction occurs in a homogeneous phase and at the end of the reaction, water is added to the reaction mixture, which creates biphasic conditions. In this case the catalyst components separated into the aqueous phase, while the product (and unconverted amine, *etc.*) remained in the organic phase. In 2011 Gupte and co-workers reported the synthesis of **11** by the oxidative carbonylation of an amine using water-soluble



Scheme 32 Possible mechanism for the PS-Pd-NHC catalysed synthesis of *N*-substituted phthalimides.

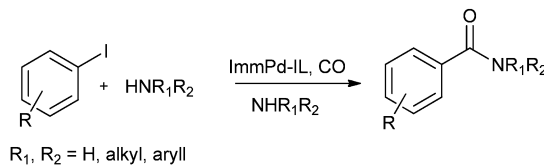

Scheme 33 Reagents and conditions: aryl iodide (1 mmol), amine (2 mmol), ImmPd-IL (2 mol%), Et₃N (3 mmol), toluene (10 mL), CO pressure (1 MPa), temp. 100 °C, time 8 h.

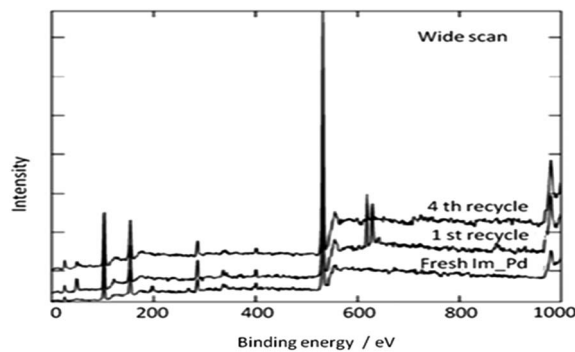

Fig. 4 XPS of the fresh and recycled ImmPd-IL catalyst.

palladium catalysts in a biphasic media (Scheme 9).¹⁷ This methodology overcomes the catalyst-product separation drawbacks of the previously reported method by Deng and co-workers.¹³

The aqueous-organic biphasic catalytic system involving a water-soluble catalyst can be of great advantage in terms of catalyst and product separation and easy recyclability.

Water soluble ligands like sulfonated *N*-containing ligands, *e.g.* disodium 2,2'-bipyridine-4,4'-disulfonate (Bipy-DS), were found to be highly active and stable under the reaction



Scheme 34 Reagents and conditions: ArBr (1 mmol, 1 equiv.), CO (4 bar), NHR_1R_2 (1.5 equiv.), Pd/ZIF-8 (24 mg, 0.21 mol% Pd), dpePhos (1 mol%), K_2CO_3 (1.5 equiv.), toluene (3 mL).

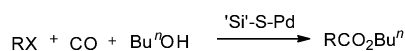

Scheme 35 Reagents and conditions: 'Si'-S-Pd (0.01 g, 0.04 mmol), iodobenzene (0.61 g, 3 mmol), $n\text{-Bu}_3\text{N}$ (0.65 g, 3.5 mmol), n -butyl alcohol (2 cm^3), CO stream, temp. 100 °C, time 25 h.



Scheme 36 Reagents and conditions: (a) aryl halide (5 mmol), n -butyl alcohol (4 mL), $n\text{-Bu}_3\text{N}$ (7 mmol), CO (1 atm), 22 (0.08 mmol) or 23 (0.078 mmol) or 24 (0.80 mmol).



Scheme 37 Reagents and conditions: aryl iodide (2.5 mmol), alcohol (2.5–3.0 mmol), Et_3N (3 mmol), 5% Pd/C (50 mg), benzene (5 mL), carbon monoxide (1 MPa), temp. 140 °C, time 6 h.



Scheme 38 Reagents and conditions: (a) iodobenzene (2.5 mmol), 5% Pd/C (5 mg), Et_3N (7.2 mmol), alcohol (4 mL), CO (0.5 MPa), temp. 130 °C, time 2 h; (b) iodobenzene (2.5 mmol), ArOH (3 mmol), 5% Pd/C (30 mg), Et_3N (7.2 mmol), toluene (4 mL), CO (2.0 MPa), temp. 130 °C, time 8 h.

conditions. The urea product could be precipitated out from the reaction medium and thus the soluble catalyst could be recycled. The oxidative carbonylation of aniline in a biphasic catalytic system using the Pd(BipyDS)Pd(OAc)₂ catalyst gave a TOF of $\sim 210 \text{ h}^{-1}$ with 97% conversion and 91% selectivity for **11**. The aliphatic amines were found to be unreactive under such



Scheme 39 Reagents and conditions: aryl iodide (0.50 mmol), alcohol (0.50 mmol), DMF (1 mL), DBU (224 μL , 1.50 mmol), Pd/C 10% (10 mg, 0.01 mmol), CO (130 psi), temp. MW, 130 °C at 150 W, time 20 min.

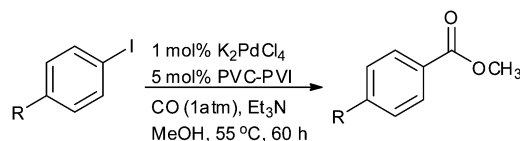

Scheme 40 Reagents and conditions: aryl iodide (0.2 mmol), Et_3N (0.4 mmol), K_2PdCl_4 (1 mol%), PVI-PVC (70 : 30) (5 mol%), methanol (2 mL), temp. 55 °C, time 60 h.



Scheme 41 Reagents and conditions: (a) aryl iodide (1 mmol), alcohol (5 mL), ImmPd-IL (2 mol%), Et_3N (3 mmol), CO pressure (0.5 MPa), temp. 80 °C, time 3 h; (b) aryl iodide (1 mmol), phenol (2 mmol), ImmPd-IL (2 mol%), Et_3N (3 mmol), toluene (10 mL), CO pressure (1 MPa), temp. 100 °C, time 8 h.

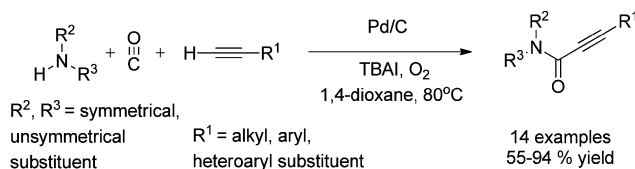

Scheme 42 Reagents and conditions: alk-1-yne (1 mmol), secondary amine (1.5 mmol), 10% Pd/C (8 mol%), CO/O_2 pressure (5/1 atm), TBAI (0.90 mmol), 1,4-dioxane (10 mL), temperature 80 °C, time 14 h.

reaction conditions. Comparison of the XPS patterns of the recovered and fresh complexes also confirmed that the molecular nature of the complex and more importantly the oxidation state of palladium remained unchanged after the reaction.

Plausible reaction mechanisms for the oxidative carbonylation reaction has been reviewed by various groups, *e.g.* Gabriele *et al.*,¹⁸ McElwee-White and co-workers¹⁹ and Ragaini.²⁰ Based on these observations, a reaction mechanism has been proposed for the oxidative carbonylation in the liquid-liquid

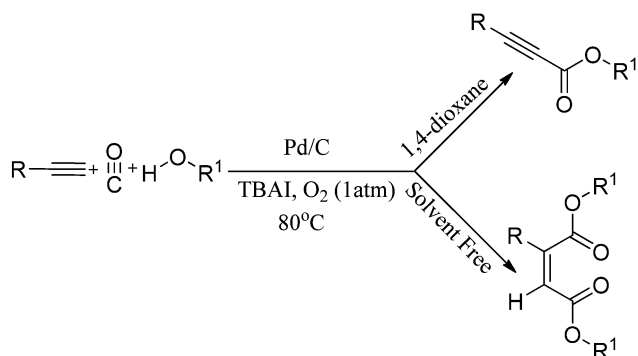

Scheme 43 Reagents and conditions: alk-1-yne (1 mmol), alcohol (0.5 mL), 10% Pd/C (10 mol%), CO/O_2 (5 : 1 atm), TBAI (0.6 mmol), 1,4-dioxane (10 mL), temp. $80^\circ C$, time 8 h. (The unsymmetrical maleate esters were formed directly by using the alcohol as the solvent under the same reaction conditions).

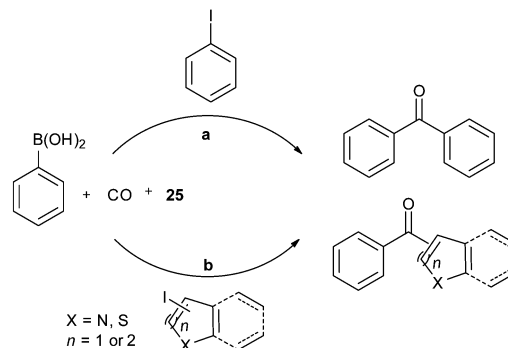

Scheme 46 Reagents and conditions: (a) aryl iodide (1 mmol), arylboronic acid (1.2 mmol), **25** (14.5 mmol), K_2CO_3 (3 mmol), toluene (10 mL), $100^\circ C$, CO (100 psi), 10 h; (b) aryl iodide (1 mmol), arylboronic acid (1.2 mmol), **25** (14.5 mmol), K_2CO_3 (3 mmol), toluene (10 mL), $100^\circ C$, CO (100 psi), 10 h.



Scheme 44 (a) Reagents and conditions: aryl iodide (1 mmol), arylboronic acid (1.1 mmol), $Pd(tmhd)_2$ (2 mol%), K_2CO_3 (3 mmol), anisole (10 mL), 6 h, $80^\circ C$, CO (100 psi); (b) heteroaryl iodide (1 mmol), arylboronic acid (1.2 mmol), $Pd(tmhd)_2$ (2.5 mol%), K_2CO_3 (3 mmol), toluene (10 mL), time 12 h, $100^\circ C$, CO (200 psi).

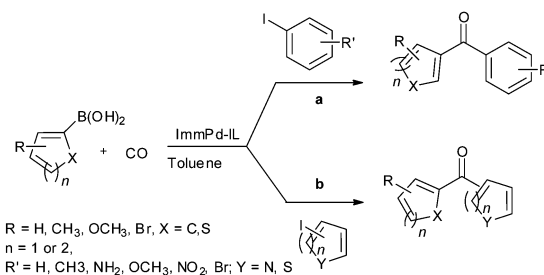

Scheme 47 Reagents and conditions: (a) aryl iodide (1 mmol), arylboronic acid (1.2 mmol), CO pressure (1 MPa), ImmPd-IL (2 mol%), K_2CO_3 (3 mmol), toluene (10 mL), $100^\circ C$, 8 h; (b) heteroaryl iodide (1 mmol), heteroaryl boronic acid (1.2 mmol), CO pressure (1 MPa), ImmPd-IL (2.5 mol%), K_2CO_3 (3 mmol), toluene (10 mL), $100^\circ C$, 10 h.

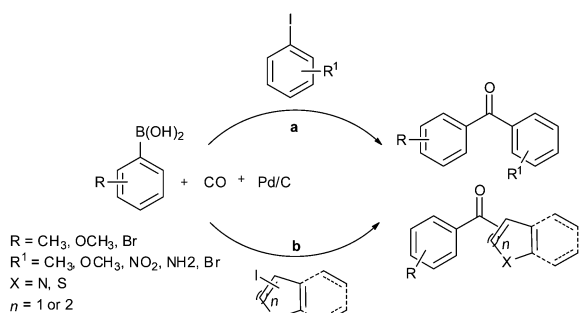

Scheme 45 Reagents and conditions: (a) aryl iodide (1 mmol), arylboronic acid (1.2 mmol), CO (200 psi), 10% Pd/C (2 mol%), K_2CO_3 (3 mmol), anisole (10 mL), $100^\circ C$, 8 h; (b) heteroaryl iodide (1 mmol), arylboronic acid (1.2 mmol), CO (200 psi), 10% Pd/C (2.5 mol%), K_2CO_3 (3 mmol), toluene (10 mL), time 10 h, temp. $100^\circ C$.

interphase of a biphasic medium (Scheme 10). The reaction mechanism highlights the role of the iodide promoter. Step I shows that complex **16** and NaI promoters leads to the formation of the active catalytic intermediate species **17**. In step II the oxidative addition of aniline to **17** generates the species **18** which undergoes CO insertion in step III to give the Pd-carbamoyl intermediate **19**. It is postulated that phenyl isocyanate is formed at the interface in step IV, which is highly reactive and is attacked by **20** to generate DPU (steps V and VI).

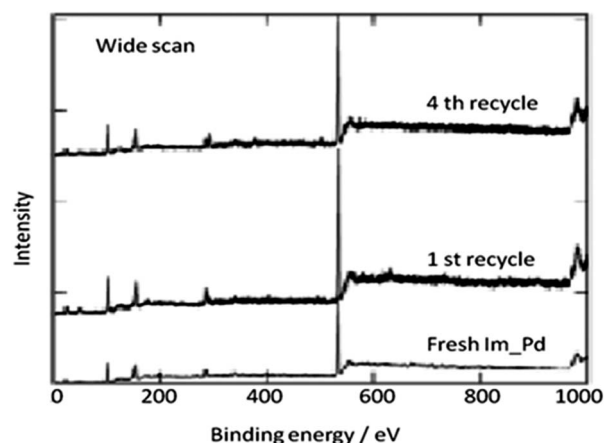

Fig. 5 XPS spectra of the fresh and recycled ImmPd-IL catalysts.

2.3 Palladium catalysed oxidative carbonylation reactions of amino alcohols, alcohols and diols

Xia and co-workers have synthesised oxazolidinones using a $Pd/C-I_2$ catalytic system by the oxidative cyclocarbonylation of amino alcohols (Scheme 11).²¹ The catalyst could be reused five times without significant loss in the catalytic activity and



Scheme 48 Reagents and conditions: aryl iodide (0.2 mmol), aryl boronic acid (0.2 mmol), Pd₂(dba)₃ (1 mol%), K₂CO₃ (3 equiv.), CO (balloon pressure), anisole (2 mL), temp. 100 °C, time 20 h.



Scheme 49 Reagents and conditions: heteroaryl iodide (0.2 mmol), heteroaryl boronic acid (0.2 mmol), Pd₂(dba)₃ (1 mol%), K₂CO₃ (3 equiv.), CO (balloon pressure), anisole (2 mL), temp. 100 °C, time 20 h.

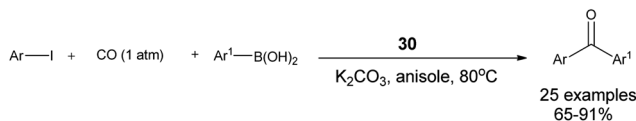
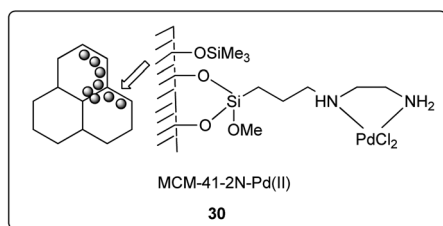

Scheme 50 Reagents and conditions: arylboronic acid (1.1 mmol), aryl iodide (1.0 mmol), CO (1 atm), K₂CO₃ (3 mmol), **30** (2 mol%), anisole (5 mL), temp. 80 °C.



Scheme 51 Reagents and conditions: aryl iodide (0.5 mmol), aryl boronic acid (0.6 mmol), CO (1 atm), K₂CO₃ (1.5 mmol), **31** (1 mol%), anisole (5 mL), temp. 80 °C.

selectivity. The catalyst system not only solves the basic problems of catalyst separation and recovery but also avoids the use of phosphine ligands. The catalyst gave high TOF values, which



Scheme 52 Reagents and conditions: aryl iodide (2.5 mmol), alkyne (3 mmol), 5% Pd/C (10 mg), Et₃N (7.2 mmol), toluene (4 mL), CO (2.0 MPa), temp. 130 °C, time 4 h.

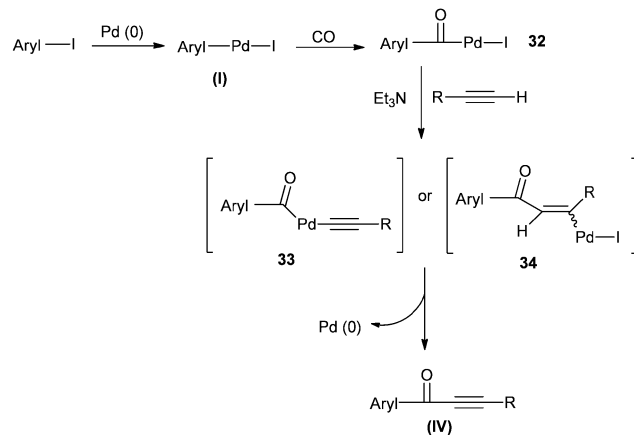

Scheme 53 Possible mechanism for the Pd/C catalyzed carbonylative Sonogashira coupling reaction.



Scheme 54 Reagents and conditions: aryl iodides (2.5 mmol), phenylacetylene alkynes (3.0 mmol), Pd/Fe₃O₄ catalyst (Pd, 1.04 wt%), 50 mg, Et₃N (7.2 mmol), toluene (5.0 mL), CO (2.0 MPa), temp. 130 °C, time 4 h.

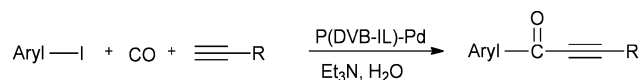

Scheme 55 Reagents and conditions: aryl iodide (1 mmol), terminal alkyne (1.2 mmol), P(DVB-IL)-Pd (20 mg, 0.005 mmol Pd), Et₃N (0.4 mL), CO pressure (3.0 MPa), distilled water (5.0 mL), temperature 130 °C, time 6 h.

are 15 times larger than the best results previously reported using homogeneous Pd catalyst systems. The 2-aminophenols are also reactive under such catalytic conditions.

A plausible mechanism shows that in the presence of iodide promoters, Pd/C is modified to **12** (Scheme 12). The active species **12** reacts with the -NH₂ group of the β-aminoalcohols and CO to produce the cabamoyl-type complexes **21**, which further react with the -OH group of the aminoalcohols to produce the oxazolidinones products.

In recent years, synthesis methods for carbonates, cyclic carbonates and furan-3-carboxylic esters have been developed using homogeneous palladium catalyzed oxidative carbonylation reactions of alcohols and diols.²² Gabriele and co-workers synthesised furan-3-carboxylic esters by the heterocyclodehydration-alkoxycarbonylation of readily available 3-yne-1,2-diol derivatives

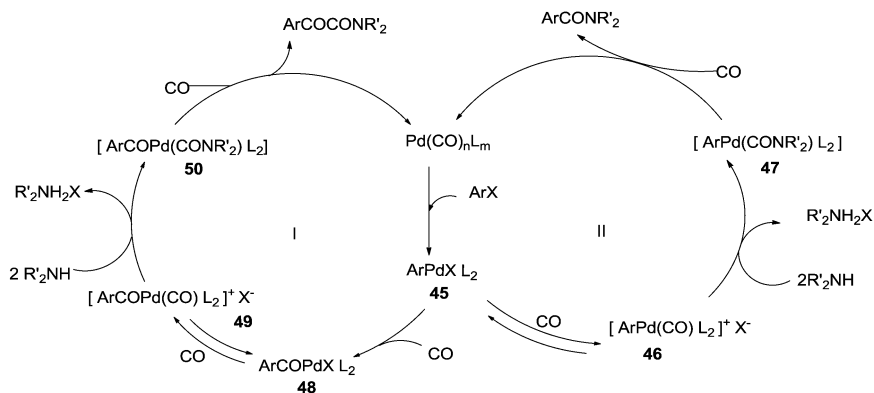

Scheme 62 Mechanistic studies of the double carbonylation of aryl iodides.

Scheme 63 Reagents and conditions: 51/PhI (0.5%), phenyl halide (5.1 mmol), E₂NH (100 mmol), temp. 100 °C, CO pressure (3.0 MPa), time 6–24 h.

Scheme 66 Reaction mechanism for the synthesis of 53 by the double carbonylation reaction of aryl iodides.

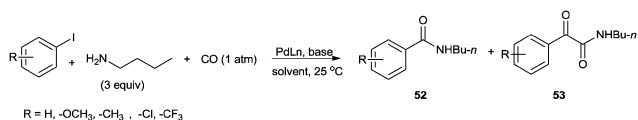
Scheme 64 Reagents and conditions: 4-iodopyridine (0.50 g, 2.44 mmol), HNEt₂ (1.2 mL, 12 mmol), Pd(OAc)₂ (5.5 mg, 0.024 mmol) and PCy₃ (19.2 mg, 0.072 mmol), CH₂Cl₂ (30 mL), CO (60 bar), temp. 50 °C, time 6 h.Scheme 67 Reagents and conditions: iodobenzene (5.0 mmol), amine (7.5 mmol), K₃PO₄ (5.0 mmol), 1,4-dioxane (3 mL), 55 (0.01 mol%), CO (10 atm), temp. 100 °C, time 15 h.Scheme 65 Reagents and conditions: iodobenzene (170 mg, 0.83 mmol), *n*-butylamine (183 mg, 2.5 mmol), [PdCl(*n*³-C₃H₅)₂] (4.6 mg, 0.0125 mmol), PPh₃ (13.1 mg, 0.05 mmol), THF (8.3 mL), DABCO (280 mg, 2.5 mmol), temp. 25 °C, CO (1 atm), time 12 h.

PdI₂-catalyzed direct oxidative carbonylation of 1,2- and 1,3-diols (Scheme 14).^{22d} The use of an excess of a dehydrating agent, such as trimethyl orthoacetate, was needed to achieve appreciable results. Li and co-workers showed various catalytic systems for the synthesis of glycerol carbonate using the oxidative carbonylation of glycerol. Such catalytic systems are PdCl₂(phen)/KI, PdCl₂(phen) with the aid of CuI, and the zeolite-Y confined Pd catalyst (PdCl₂(phen)@Y)

(Scheme 15).^{22ef} The zeolite based catalyst showed comparable activity to its homogeneous counterpart and could be reused five times without any significant decrease in activity.

Muller and co-workers synthesised cyclic carbonates by the oxidative carbonylation of polyols. Polyols are easily available from bio-feedstock and can be converted efficiently into their corresponding cyclic carbonates by using a Wacker-type Pd/Mn catalyst system.^{22g} Waymouth and co-workers synthesised 5- and 6-membered cyclic carbonates.^{22h} The sterically uncongested 1,2- and 1,3-diols were found to be reactive substrates for the catalyst.

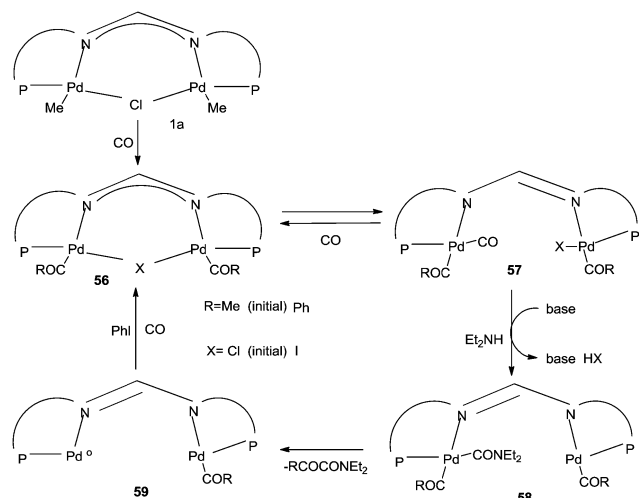

Scheme 68 Double carbonylation of aryl iodide using a dinuclear palladium complex catalyst.



Scheme 69 Double carbonylation of aryl iodides catalysed by a Pd(*t*-Bu₃P)₂ catalyst.



Scheme 70 Reagents and conditions: microflow system: aryl iodide (14.0 mmol), Et₂NH (70 mmol, 5.0 equiv.), CO (20 or 15 atm), Pd cat. (0.5 mol%) in [BMIm]PF₆ (17 mL); flow rates: mixture of aryl iodide and Et₂NH (0.04 mL min⁻¹), Pd/[BMIm]PF₆ (0.14 mL min⁻¹), CO (0.25 mL min⁻¹), temp. 80 °C, residence time 34 min; conventional batch system: aryl iodide (2.66 mmol), Et₂NH (5.0 equiv.), Pd cat. (0.5 mol%), [BMIm]PF₆ (2.0 mL), CO (20 or 15 atm), 80 °C, time 5 h.



Scheme 71 Double carbonylation of aryl bromides in a micro reactor system.

2.4 Miscellaneous oxidative carbonylation reactions

The oxidative carbonylation reaction is an efficient methodology for the direct insertion of the carbonylation functionality by activation of the C–H bond. Various homogeneous palladium

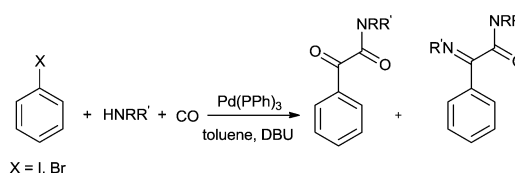

Scheme 72 Reagents and conditions: aryl halide (0.05 M), amine (0.05 M or 0.1 M), DBU (0.1 M), immobilized Pd(PPh₃)₄ (0.4 g), flow rates between 0.2 and 0.5 mL min⁻¹, CO (40 bar), temp. 70–100 °C.

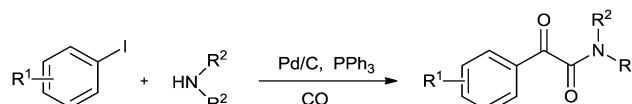

Scheme 73 Reagents and conditions: aryl iodide (1.0 mmol), amine (1.5 mmol), DABCO (2.0 mmol), the molar ratio of catalyst/PPh₃/substrate = 1/4/100, solvent (6.0 mL), CO (4.0 MPa), temp. 60 °C, temp. 20 h.

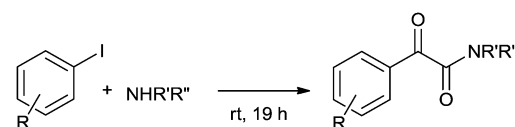

Scheme 74 Reagents and conditions: aryl iodide (0.5 mmol), amine (2 equiv.), room temperature, time 19 h; chamber 1: Pd(dba)₂ (2 mol%), HBF₄P(*t*Bu)₃ (4 mol%), DBU (2 equiv.), THF; chamber 2: COgen (1.5 mmol), Pd(dba)₂ (5 mol%), P(*t*Bu)₃ (10 mol%), Cy₂NME (2 equiv.), DMF.



Scheme 75 Reagents and conditions: aryl iodide (1 mmol), amine (2 mmol), K₂CO₃ (2 mmol), PdCl₂(PPh₂)₂@SBA-15 (1 mol% [Pd]), MEK (5 mL), temp. 60 °C, CO 40 bar, time 48 h.

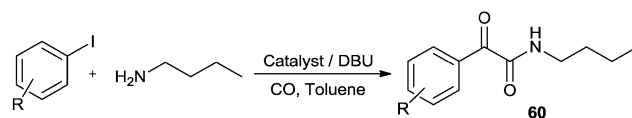

Scheme 76 Reagents and conditions: aryl iodide (0.5 mmol), amine (1.2 mmol), catalyst [Pd(*n*³-C₃H₅)(μ-Cl)]₂ (0.005 mmol), DBU (1 mmol), toluene (5 mL), CO (1 bar).

catalysts along with an oxidant are used for the carbonylative synthesis of xanthenes, phenanthridinones, chalcones, esters, acids, *etc.*²³ Classically, esters, acids and amides were synthesised using aryl halides. These oxidative carbonylation methods carbonylatively activate the C–H bond of arenes and heteroarenes, and eliminate the need for aryl halides, providing an environmentally benign protocol for the synthesis of valuable chemicals.

During the past decade, increased attention has focused on the Pd-catalyzed aromatic C–H functionalization/carbonylation.



Scheme 77 Proposed mechanism for the double carbonylation reaction of aryl halides in the presence of DBU.



Scheme 78 Reagents and conditions: iodobenzene (0.2 mmol), secondary amine (0.5 mmol), Et₃N (0.25 mmol), catalyst (3.6 μmol Pd-content), DMF 1 mL, CO 30 bar, temp. 100 °C, time 3 h.

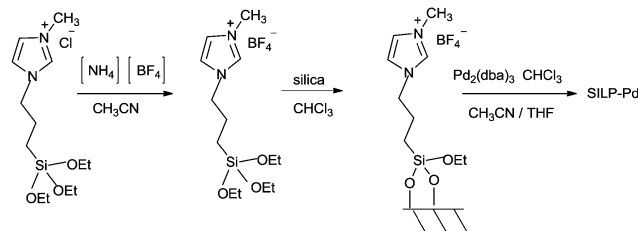

Scheme 79 Preparation of the silica supported phosphine-free catalyst (SILP-Pd).

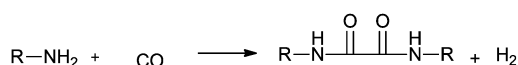

Scheme 80 Reagents and conditions: *n*-decylamine (7.9 g), PdCl₂ (0.5 g), benzene (30 mL), CO (100 kg cm⁻²), temp. 180 °C, time 20 h.

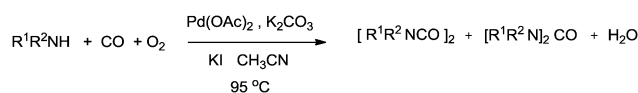

Scheme 81 Reagents and conditions: amine (1.5 mmol), Pd(OAc)₂ (0.022g, 0.10 mmol), KI or (C₄H₉)N⁺I⁻ (0.2–0.8 mmol), K₂CO₃ (1.5 mmol), THF (10 mL), CO (2.7 atm), O₂ (1 atm), temp. 95 °C, time 3 h.

Lei and co-workers synthesised xanthenes by the Pd-catalyzed double C–H functionalization/carbonylation of diaryl ethers (Scheme 16).^{23a}

Chuang and co-workers synthesised phenanthridinone derivatives by the palladium catalyzed oxidative carbonylation of *N*-sulfonyl-2-aminobiaryls through C–H bond activation and C–C, C–N bond formation under TFA-free conditions (Scheme 17).^{23b}



Scheme 82 Proposed reaction mechanism for the oxamide synthesis.



Scheme 83 Reagents and conditions: diethylamine (2.07 mL, 20.0 mmol), *trans*-[PdCl₂(PPh₃)₂] (17.5 mg, 0.0250 mmol), THF (3 mL), 1,4-dichloro-2-butene (0.540 mL, 5.00 mmol), carbon monoxide (1 to 100 atm), rt, time 3–17 h.



Scheme 84 Proposed mechanism for the catalytic carbonylation of a secondary amine to form an oxamide with DCB as an oxidant.

Lei and co-workers showed the regioselective aerobic oxidative C–H carbonylation of heteroarenes using a balloon pressure of CO (Schemes 18–20).^{23c} This oxidative carbonylation catalytic system was also applied to the aerobic N–H carbonylation of *N*-free indoles to afford various indole carbamates. Later on,



Scheme 85 Reagents and conditions: amine (1.0 mmol), PdCl₂(MeCN)₂ (0.05 mmol), CuI (0.15 mmol), alcohol (50 mmol), dehydrating reagent CH(OMe)₃ (2 mmol), CO (80 kg cm⁻²), O₂ (5 kg cm⁻²).

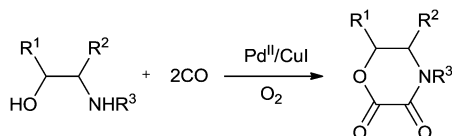

Scheme 86 Reagents and conditions: amino alcohol (1 mmol), PdCl₂(MeCN)₂ (0.05 mmol), CuI (0.25 mmol), acetonitrile (2 mL), CO (80 kg cm⁻²) and O₂ (5 kg cm⁻²), rt, time 20 h.



Scheme 87 A plausible reaction mechanism for the cross double carbonylation reaction of an amine and an alcohol for the synthesis of an oxamate.



R¹, R² = allylic, benzylic, aliphatic, heterocyclic symmetrical and unsymmetrical substituents

Scheme 88 Reagents and conditions: amine (1 mmol), alcohol (10 mL), 10% Pd/C (8 mol%), TBAI (0.2 mmol), CO/O₂ (6 : 1 atm), temp. 60 °C, time 2 h.

Lang *et al.* reported the oxidative iodination and subsequent Pd⁰-catalyzed carbonylation of heteroarenes.^{23d} Wrigglesworth *et al.* showed the heteroannulation reactions of *N*-alkoxybenzamides by a Pd(II) catalyzed carbonylative C–H activation

reaction.^{23e} Beller and co-workers synthesised chalcones by palladium catalyzed oxidative carbonylative coupling reactions of arylboronic acids with styrenes (Scheme 21).^{23f} This reaction proceeds under mild conditions using air as an oxidant.

Bell and co-workers showed the mechanism and kinetics of the liquid-phase oxidative carbonylation of toluene to toluic acid over Pd(II) in the presence of trifluoroacetic acid, trifluoroacetic anhydride, and molecular oxygen.^{23g} Elman synthesised 2,6-naphthalenedicarboxylic acid *via* the liquid-phase oxidative carbonylation of naphthalene using a Pd(OAc)₂/K₂S₂O₈ catalytic system.^{23h} The reaction goes *via* the formation of naphthalic anhydride (NAN) by oxidative carbonylation, subsequent alkaline hydrolysis of NAN and isomerization giving 1,8-naphthalenedicarboxylic acid, which is known to lead to 2,6-naphthalenedicarboxylic acid. Sarkar and Chaudhari synthesised a Pd(pyca)(PPh₃)(OTs) complex anchored on different mesoporous matrices, such as MCM-41, MCM-48 and SBA-15. Such anchored Pd-complex catalysts were found to be effective for the hydrocarboxylation of alkenes or alcohols to acids.²³ⁱ The materials showed excellent activity, regioselectivity, stability and recyclability for the low-pressure carbonylation of olefins and alcohols.

Lei and co-workers synthesised aromatic esters by the oxidative carbonylation of arylboronic acid derivatives under balloon pressure of CO with air as the oxidant using [PdCl₂(PPh₃)₂] as the catalyst precursor (Scheme 22).^{23j}

Jiang and co-workers synthesised β-enoic acid esters by the palladium-catalysed direct oxidative carbonylation of allylic C–H bonds with carbon monoxide (Scheme 23).^{23k}

Huang and co-workers developed an efficient Pd-catalyzed carbonylation of benzylic C–H bonds with CO through nondirected C(sp³)–H bond activation.^{23l} This process represents a practical and efficient methodology for the synthesis of substituted phenylacetic acid esters from simple toluene.

3. Heterogeneous palladium catalysed aminocarbonylation and alkoxy carbonylation reactions

Palladium catalysed aminocarbonylation and alkoxy carbonylation reactions of aryl halides and alkynes are efficient methods for the synthesis of amides and esters.^{8d,f,24} Various homogeneous and heterogeneous palladium catalysed protocols have been developed for the synthesis of these valuable products.^{8d,f}

3.1 Heterogeneous palladium catalysed aminocarbonylation reactions of aryl halides

Cai and co-workers reported a silica-supported bidentate phosphine palladium complex (abbreviated as 'Si'-2P-Pd) for the Heck carbonylation of aryl halides (Scheme 24).²⁵ The catalytic activity of 'Si'-2P-Pd was comparable to that of the analogous homogeneous (Pd(PPh₃)₂Cl₂) catalyst. The catalyst could be separated from the product by a simple filtration and could be reused without any noticeable deactivation.

In 2004 the same group reported a silica-supported bidentate arsine palladium complex **22** (abbreviated as 'Si'-2As-Pd),²⁶ a silica-supported poly- γ -diphenylarsinopropylsiloxane palladium complex **23** (abbreviated as 'Si'-As-Pd)²⁷ and a silica-supported sulfur and phosphine mixed bidentate palladium complex **24** (abbreviated as 'Si'-S,P-Pd(II))²⁸ as heterogeneous and reusable catalysts for the aminocarbonylation of aryl halides (Scheme 25). Both aryl iodides and activated aryl bromides under atmospheric pressure of CO gave aminocarbonylation and the catalyst could be recovered and reused.



Csajági and co-workers reported the aminocarbonylation of iodobenzoic acids in a micro/meso fluidic continuous flow reactor using a polymer-supported tetrakis(triphenylphosphine) palladium catalyst.²⁹ The method gave improved results over comparable batch techniques. Petricci and co-workers described the microwave-assisted aminocarbonylation of aryl iodides in the presence of a Pd/C catalyst at 10 bar and 130 °C (Scheme 26).³⁰ The catalyst could be recycled for up to two runs without considerable differences in the reaction yields.

In 2008, Bhanage and co-workers reported the aminocarbonylation of aryl iodides by *N,N'*-dimethylformamide (DMF) as a non-gaseous CO source using Pd/C as a heterogeneous catalyst (Scheme 27).³¹ The catalyst showed excellent reusability. Pd leaching was examined and effective redeposition of Pd metal on the support was carried out using a thermal deposition technique.

Redeposition of the catalyst was monitored using ICP-AES analysis. At 140 °C, efficient redeposition of Pd took place and the Pd content was found to be 4.45 ppm, which was in agreement with a literature report for a similar catalyst system used for the Heck reaction.³² Afterwards, the same group reported Pd/C and a polymer-supported palladium-*N*-heterocyclic carbene complex (PS-Pd-NHC) **25** as heterogeneous, phosphine free and recyclable catalysts for the synthesis of *N*-substituted phthalimides using a variety of substrates such as *o*-dihaloaryls, *o*-halobenzoate and *o*-halobenzoic acid (Schemes 28–30).³³ Using Pd/C, they examined the ICP-AES analysis of the 1st and 8th recycle run, where the palladium in solution was estimated below 0.01 ppm and thus no significant leaching of the palladium catalyst was observed. The catalyst **25** was prepared by the reported literature procedure.³⁴ It was found that **25** was also an effective catalytic system for the aminocarbonylation of aryl halides (Scheme 31).³⁵ Various aliphatic and aromatic amines undergo carbonylation with aromatic and heteroaromatic

halides to provide an excellent yield of the amides. The polymer supported catalyst was found to show remarkable recyclability without loss in catalytic activity and selectivity.

A plausible mechanism for the synthesis of *N*-substituted phthalimides (Scheme 32) shows that the reaction goes by an acylpalladium complex **26**. Complex **26** then reacts with the amine to give intermediate **27**, which, in the presence of base, gives intermediate **28**. Species **28** is then cyclised to produce intermediate **29**, which can reductively eliminate to give the corresponding *N*-substituted phthalimide product.

In 2013 the same group reported an immobilized palladium metal-containing ionic liquid (ImmPd-IL), which is a structurally well-defined transition metal complex, as a heterogeneous, phosphine-free catalytic system for aminocarbonylation of aryl halides (Scheme 33).³⁶ The ImmPd-IL catalyst could be easily recovered and reused for up to four consecutive cycles. The recycled catalyst was characterized using XPS analysis, which indicated that after the fourth recycle run, reduction of the Pd²⁺ species to the Pd⁰ species takes place (Fig. 4).

Seayad and co-workers reported Pd nanoparticles supported on a zeolitic imidazole framework (ZIF-8) as a robust and efficient catalyst for the aminocarbonylation of both aryl bromides and iodides (Scheme 34).³⁷ There are several advantages to using ZIF-8 as a support. It has a high surface area, is easy to prepare, has high stability in water, and has high temperature tolerance in the presence of methanol and acids/bases. The catalyst is recyclable and a TON of 2540 was achieved in a single batch reaction.

3.2 Heterogeneous palladium catalysed alkoxycarbonylation reactions of aryl halides

Reddy *et al.* reported a polymer-anchored phosphine palladium complex catalysed ethoxycarbonylation of organic halides in ethanol.³⁸ The activity of the catalyst was moderate and decreased gradually with repeated use. Huang reported a silica-supported poly[3-(2-cyanoethylsulfanyl)propylsiloxane palladium] complex (abbreviated as 'Si'-S-Pd) as an efficient catalyst for the carbonylation of aryl bromides/iodides using carbon monoxide and *n*-butyl alcohol (Scheme 35).³⁹ The 'Si'-S-Pd catalyst was separated from the mixture by filtration and reused.

Cai and co-workers described **22**,²⁶ **23**²⁷ and **24**²⁸ as heterogeneous and reusable catalysts for the butoxycarbonylation of aryl iodides and activated aryl bromides (Scheme 36).

In 2003, Sugi and co-workers reported the Pd/C catalysed alkoxycarbonylation of aryl iodides (Scheme 37).⁴⁰ The Pd/C catalyst could be recovered after the reaction, and reused for further reactions. Chen and Xia reported the alkoxy and phenoxycarbonylation of aryl halides using Pd/C as a novel, efficient, versatile, recyclable, and phosphine-free catalytic system (Scheme 38).⁴¹ The Pd/C catalyst was reused several times with no significant loss in the catalytic activity and selectivity.

Petricci and co-workers reported the alkoxycarbonylation of aryl iodides using Pd/C as a heterogeneous catalytic system under microwave dielectric heating conditions (Scheme 39).³⁰ Various alcohols such as aliphatic, alicyclic, chiral alcohols, and phenols showed excellent reactivity towards carbonylation with

aryl iodides. The Pd/C catalyst was recycled for up to two runs without a considerable decrease in the yield of the products.

Beletskaya and Ganina reported palladium nanoparticles immobilised on poly(*N*-vinylimidazole-co-*N*-vinylcaprolactam) (PdNPs/PVI-PVC) in methanol for the alkoxy carbonylation of aryl iodides (Scheme 40).⁴² The PdNPs/PVI-PVC catalyst could be recycled several times without loss of activity.

In 2013 Bhanage and co-workers reported the alkoxy and phenoxy carbonylation of aryl iodides using an immobilized palladium metal-containing ionic liquid (ImmPd-IL) as a heterogeneous and phosphine-free catalytic system (Scheme 41).³⁶ The reaction avoids the use of phosphine ligands and the precious palladium metal catalyst could be recovered. The catalyst showed excellent recyclability for up to four consecutive cycles of the methoxy carbonylation reaction.

3.3 Heterogeneous palladium catalysed amino and alkoxy carbonylation reactions of terminal alkynes

In 2012, Gadge *et al.* synthesised alk-2-ynamides by the oxidative aminocarbonylation of terminal alkynes with secondary amines using Pd/C as a heterogeneous and reusable catalyst (Scheme 42).⁴³ Various aromatic, heteroaromatic, and aliphatic terminal alkynes underwent aminocarbonylation reactions with excellent product yields. Only secondary amines were found to be effective. Primary amines were found to give the urea as the major product. The developed methodology avoids the use of phosphine ligands and bases, and has the additional advantages that the palladium catalyst can be recovered and reused for up to four consecutive cycles. The ICP-AES analysis of the reaction mixture on a larger scale (4 mmol of alk-1-yne) showed that the palladium content was below the detectable level, indicating no significant leaching.

Instead of using amines as nucleophiles, the same group demonstrated the phosphine-free oxidative alkoxy carbonylation of terminal alkynes using alcohols in the presence of Pd/C as a heterogeneous catalyst (Scheme 43).⁴⁴ In the presence of 1,4-dioxane solvent, the reaction provides α,β -alkynyl esters. However, with only ethanol, double carbonylation takes place to produce selectively unsymmetrical maleate esters. Various aromatic, heteroaromatic and aliphatic terminal alkynes resulted in excellent yields of the α,β -alkynyl esters and unsymmetrical maleate esters. The catalytic system has competitive advantages since it eliminates the use of phosphine ligands, bases and acids. In addition to this, the catalyst can be easily separated and recovered, allowing it to be reused several times without significant loss in the catalytic activity and selectivity.

4. Phosphine-free carbonylative Suzuki and Sonogashira coupling reactions

Biaryl ketones and α,β -alkynyl ketones are important moieties in many biologically active molecules, natural products, and pharmaceuticals. Palladium catalysed carbonylative Suzuki and Sonogashira reactions have provided attractive routes for the synthesis of these ketones using aryl halides, gaseous CO and

one of the partner boronic acids or terminal alkynes respectively.⁴⁵ Various homogeneous palladium catalysts, along with N/P-containing ligands have been developed for these reactions.⁴⁶ Heterogeneous and ligand-free palladium catalysed reactions for the synthesis of these biaryl ketones and α,β -alkynyl ketones would be more desirable from economical and environmental points of view. The carbonylative Sonogashira coupling reaction is generally reported using CuI as a co-catalyst, but recently new catalytic systems have investigated eliminating the co-catalyst. The high cost of transition metal catalysts and the toxic effects associated with them has led to an increased interest in immobilizing catalysts onto a support. Such heterogeneous and phosphine ligand-free cross-coupling reactions have been enthusiastically investigated because of their current toxicity and cost burden, and the difficulty in purifying the product from the reaction mixture.

4.1 Phosphine-free palladium-catalysed carbonylative Suzuki coupling reactions

In 2009, Bhanage and co-workers discovered Pd(tmhd)₂/Pd(OAc)₂ as a phosphine-free catalyst for the carbonylative Suzuki reaction for biaryl ketones synthesis (Scheme 44).⁴⁷ The developed protocol was applicable for both aryl and heteroaryl iodides with various boronic acids using phosphine-free homogeneous palladium complexes. The loss of the precious palladium metal catalyst was the main issue under such reaction conditions. Afterwards various heterogeneous supported palladium catalysts were investigated for such reactions, which includes Pd/C (Scheme 45),⁴⁸ PS-Pd-NHC (Scheme 46)⁴⁹ and ImmPd-IL catalysts (Scheme 47).⁵⁰ The advantages of all these methods are: the easy separation of the catalyst and product, catalyst recoverability, catalyst recyclability, and avoiding the use of expensive phosphine ligands. XPS spectra were measured for the fresh ImmPd-IL catalyst, the catalyst after the 1st recycle and the catalyst after the 4th recycle (Fig. 5). The wide scan showed that the fresh and recycled catalysts do not differ much. All these methods were applicable to aryl/heteroaryl iodides and resulted in excellent product yields.

Yang and Xue reported Pd₂(dba)₃ as a ligand-free catalyst under atmospheric pressure of carbon monoxide with high TONs up to 1700 (Scheme 48).⁵¹ The catalytic system was also applicable to a broad range of heteroaryl iodides with heteroaryl boronic acids (Scheme 49). The catalyst was recovered simply by filtration and it was found that the activity of the catalyst remained after four consecutive runs.

Cai and co-workers discovered a 3-(2-aminoethylamino) propyl-functionalized MCM-41-immobilized palladium(II) complex **30** as a phosphine-free heterogeneous catalyst for the carbonylative cross-coupling of aryl iodides with aryl boronic acids under an atmospheric pressure of carbon monoxide (Scheme 50).⁵² The MCM-41 support has a high surface area and large pore size, and the catalytic palladium species is anchored on the inner surface of the mesopores of the MCM-41 support and exhibit a high activity and good reusability. The catalyst and product could be separated by a simple filtration procedure and the catalyst was recycled up to ten consecutive trials without any

decrease in activity. Niu *et al.* discovered magnetically separable mercaptopropyl-modified silica-coated palladium nanoparticles ($\text{Fe}_3\text{O}_4@\text{SiO}_2\text{-SH-Pd}^{\text{II}}$) **31** and used them for the Suzuki carbonylative cross-coupling reaction (Scheme 51).⁵³ The catalyst could be magnetically separated from the solution phase and reused five times without any significant loss in the catalytic activity and selectivity.

4.2 Phosphine-free palladium-catalysed carbonylative Sonogashira coupling reactions

Xia and co-workers reported Pd/C as an efficient, versatile, recyclable, and phosphine-free catalytic system for the carbonylative Sonogashira coupling reaction of aryl iodides with terminal alkynes for the first time (Scheme 52).⁵⁴

The reaction avoids the use of CuI as a co-catalyst. This catalytic system is advantageous as there is no need to add phosphine ligands and the catalyst can be easily recycled, allowing it to be reused several times.

A possible reaction mechanism (Scheme 53) shows that the carbonylative coupling product was obtained through **33** *via* the electron deficient acylpalladium complex **32**. An alternative route is the insertion of an arylalkyne into the **32** species to give **34**, followed by β -hydrogen elimination. The same group then reported two different catalytic systems for the carbonylative Sonogashira reaction. The first one is based on a magnetically separable palladium catalyst ($\text{Pd}/\text{Fe}_3\text{O}_4$) (Scheme 54)⁵⁵ and the second one is based on a cross-linked polymer-supported ionic liquid immobilized palladium catalyst ($\text{P}(\text{DVB-IL})\text{-Pd}$) (Scheme 55).⁵⁶ The magnetically separable $\text{Pd}/\text{Fe}_3\text{O}_4$ catalyst was prepared by the wet impregnation of Fe_3O_4 with $\text{Na}_2[\text{PdCl}_4]$, followed by reduction with KBH_4 , and it consists of Pd particles of 5 nm in diameter entrapped in iron oxide nanoparticles. The $\text{Pd}/\text{Fe}_3\text{O}_4$ catalyst was recycled seven times after magnetic separation without loss in activity and selectivity (Fig. 6). Both catalytic systems not only solve the basic problem of palladium metal recovery, but also avoid the use of toxic and expensive phosphine ligands.

Cai and co-workers reported a heterogeneous carbonylative Sonogashira coupling reaction using a MCM-41-supported bidentate phosphine based palladium(0) complex catalyst [$\text{MCM-41-2P-Pd}(0)$] (Scheme 56).^{57a} This polymeric palladium catalyst could be reused at least ten times without any decrease in activity. A plausible reaction mechanism is shown in Scheme 57. When an electron-rich aryl iodide is used as a substrate, the insertion reaction of CO to the less reactive arylpalladium complex **35** can proceed smoothly, giving the corresponding acylpalladium complex **36**. Complex **36** reacts with a terminal alkyne in the presence of Et_3N to afford **37** and the carbonylative coupling product **38**, respectively. When an electron-deficient aryl iodide is used as the substrate in the presence of Et_3N , the electron-deficient arylpalladium complex **35** reacts too rapidly with a terminal alkyne without insertion of CO, affording the direct Sonogashira coupling products in good yields. Djakovitch and co-workers synthesised several organophosphino palladium complexes grafted on SBA-15 silica or incorporated within the walls of SBA-3 silica, and applied them to the carbonylative

Sonogashira reaction, particularly concerning the leaching/redeposition phenomena.^{57b} The catalyst showed successive recycling runs.

5. Palladium-catalysed double carbonylation reactions of aryl halides and amines

Palladium catalysed double carbonylation of amines and aryl halides is an important reaction for the synthesis of α -keto amides, oxamides and oxamates. Previous routes for the synthesis of these products involves the use of thermally unstable oxalyl chloride based chemicals such as the monoester of oxalyl chloride or diesters of oxalic acid.⁵⁸ The synthesis of these starting materials involves a multistep synthesis and isolation procedures require a distillation setup.^{58a} The alternative to these routes is the double carbonylation reaction. Various palladium metal salts and phosphine ligands have been developed to achieve these valuable products using the double carbonylation technique. Two basic routes have been proposed for the double carbonylation of aryl halides to α -keto amides (Scheme 58).⁵⁹ The first step is an oxidative addition of the aryl halide on the transition metal catalyst to produce **39** (step a). An oxidative addition followed by the migratory insertion of CO (step b), gives the acylmetal complex **40**. Then, two routes may be possible. Route A proposes a further migratory insertion of CO to **40**, creating the ($-\text{CO}-\text{CO}-$) chaining species **41** (step c), followed by a nucleophilic attack on the α -carbonyl of the formed ligand to liberate the double carbonylated product **42** (step d). Route B proposes a nucleophilic attack on a terminal CO of **43** (step f), then a carbon-carbon coupling of complex **44** would afford **42** (step g).

For the synthesis of oxamides and oxamates, a palladium catalysed oxidative carbonylation methodology has been developed. The palladium catalysed double carbonylation methodology has provided an atom economical, environmentally benign protocol for the synthesis of these valuable products.

5.1 Palladium-catalysed double carbonylation reactions of aryl halides for the synthesis of α -keto amides

In 1982, Tanaka demonstrated the synthesis of α -keto amides by the double carbonylation of aryl and heteroaryl halides using the dichloro[1,4-bis(diphenylphosphino) butane]palladium complex, $[\text{PdCl}_2(\text{dppb})]$, under a CO atmosphere (Scheme 59).⁶⁰ Various secondary amines gave excellent yields of the desired products, however with primary amines the imine of the α -keto amide was obtained as the main product.

Yamamoto and co-workers reported the double carbonylation of aryl iodides, bromides and chlorides using $\text{PdCl}_2(\text{PMePh}_2)_2$ as a catalytic system for the synthesis of α -keto amides (Scheme 60).⁶¹ A reaction mechanism for the double carbonylation reaction has been proposed in Scheme 61. It is undecided whether the double carbonylation reaction proceeds by a double CO insertion into a Pd-C bond giving a RCOCO-Pd species to be trapped by an amine or by a single CO insertion

giving a CO-coordinated acylpalladium species RCO-Pd(CO) , followed by attack of the amine on the coordinated CO to give acyl-carbamoyl species RCO-Pd-CO-NR_2 , which reductively eliminates to form RCOCONR_2 .

In 1985 the same research group studied the detailed mechanism of the diphenylmethylphosphine palladium complex catalysed double carbonylation of aryl halides (Scheme 62).⁶²

The reactivity of the phenyl halides decreases in the order $\text{PhI} > \text{PhBr} \gg \text{PhCl}$. Highly basic secondary amines were found to be the best substrates for the α -keto amide synthesis, while the selectivity for the α -keto amide formation decreased with decreasing steric bulk. Primary amides are not suitable for the double carbonylation reaction. The mechanism consists of two catalytic cycles to produce α -keto amides and amides. Cycle **I** produces the α -keto amide whereas cycle **II** yields the amide. The reaction goes *via* an oxidative addition of the aryl halide to a zero-valent palladium species to give the common intermediate arylpalladium complex **45** for both cycles. A highly reactive amine attacks the coordinated CO in the arylcarbonylpalladium species **46** to give the arylcarbamoyl species **47**. After reductive elimination the amide is generated as well as the zero-valent palladium species. When a less reactive amine was used, the intermediate **46** converts to the aroylpalladium species **48**. After CO insertion the ionic species is generated (**49**) and this is attacked by the amine to generate the aroylcarbamoyl species **50**. Finally, a reductive elimination step gives the α -keto amide. The smooth formation of the aroylpalladium intermediate **48** is key to the successful double carbonylation reaction of the aryl halide. The migration step, forming **48** from the intermediate **46**, is greatly influenced by the electron density of the aryl moiety. Aryl halides with electron withdrawing groups have been regarded as unfavourable substrates and the protocol is only applicable to those aryl halides without electron withdrawing groups. Miura *et al.* demonstrated the formation of α -keto amides at atmospheric pressure of CO.⁶³ By adding CuI as a co-catalyst, the uptake of CO could be promoted and the rate of reaction is enhanced. Yan and co-workers prepared silica-supported polytitazane-palladium complex **51** and used it to catalyse the double carbonylation reaction of phenyl halides (Scheme 63).⁶⁴ It was found that the reactivity of the phenyl halides decreased in the order of $\text{PhI} > \text{PhBr} \gg \text{PhCl}$. The catalyst could be reused ten times without any noticeable decrease in the catalytic activity and selectivity. In 1999, Carpentier and Castanet used the double carbonylation method for the synthesis of α -keto amides using 4-iodopyridines, CO and diethylamine in the presence of a catalytic amount of $\text{Pd(OAc)}_2(\text{PCy}_3)$ complex catalyst (Scheme 64).⁶⁵

The reaction resulted in more than 90% yield of the α -keto amides under mild conditions. Uozumi and co-workers synthesised α -keto amides by the double carbonylation of aryl iodides with primary amines under atmospheric pressure and ambient temperature conditions using the $\text{Pd/PPh}_3/\text{DABCO}/\text{THF}$ system (Scheme 65).⁶⁶ High selectivity for the double carbonylation reaction was obtained using DABCO as a base. In the presence of other bases such as Et_3N , pyridine and DBU, the selectivity decreased. The role of DABCO is not properly

understood in the double carbonylation reaction. The reaction mechanism shows that the irreversible alkyl migration step forming **54** is the divergence of the reaction pathway towards the double carbonylation reaction for the synthesis of **53** (Scheme 66). The protocol is only applicable to those aryl iodides without electron withdrawing groups.

Inoue and co-workers reported the dinuclear palladium complexes **55** bridged by a novel PNNP ligand (dpfam) for the double carbonylation of iodobenzene (Scheme 67).⁶⁷ The catalytic system allowed the double carbonylation reaction to proceed with a TON up to 105 and a selectivity of 96%.

A plausible mechanism proposed for the **55**-catalysed double carbonylation reaction is shown in Scheme 68. Insertion of CO gives the acetyl complex **56**, which was confirmed by NMR analysis. Coordination of a second molecule of CO to species **56** generates intermediate **57**. Nucleophilic attack of the amine generates the acyl-carbamoyl species **58**, which on reductive elimination generates the $\text{Pd}^0\text{Pd}^{\text{II}}$ bimetallic species **59**. The intermediate **59** undergoes oxidative addition with iodobenzene and continues the cycle by CO insertion through the acyl species **56**.

Iizuka and Kondo showed that the use of *t*- Bu_3P as a ligand dramatically improved the generality of the double carbonylation reaction of aryl iodides (Scheme 69).⁶⁸ Using *t*- Bu_3P as a ligand resulted in almost complete selectivity for the α -keto amide at room temperature and atmospheric pressure of CO in THF.

Moreover, this altered protocol gave access to the double carbonylation reaction of electron-deficient aryl iodides. Rahman *et al.* developed a low pressure microflow system for the palladium catalyzed double carbonylation of aryl iodides in an ionic liquid (Scheme 70).⁶⁹ In comparison with a conventional batch system, the microflow system resulted in superior selectivity and higher yields for the α -keto amide synthesis (Scheme 70). Murphy *et al.* developed a microreactor system for the double aminocarbonylation reaction of aryl iodides.⁷⁰ Microreactors have enhanced heat and mass transfers, reduced reaction volumes, and the ability to run several experiments within a sealed system. They also have the additional advantage of continuous flow. Here both electron donating and electron withdrawing substituents on aryl bromide showed remarkable activity for the double carbonylation reaction (Scheme 71).

Balogh *et al.* showed the double carbonylation reaction of iodobenzene in the presence of various amines with high selectivity in a microfluidic-based flow reactor (X-CubeTM)^{29,71} using an immobilized $\text{Pd(PPh}_3)_4$ catalyst (Scheme 72).⁷² The double carbonylation reaction observed selectively at 80 °C using DBU as the base. At higher temperatures the imine was observed as a side product.

In 2009 Xia and co-workers used Pd/C-PPh_3 as a simple and efficient catalyst system for the double carbonylation reaction of aryl iodides.⁷³ The reaction proceeded under homogeneous conditions through a leached palladium species from the Pd/C source (Scheme 73). Skrydstrup discovered the palladium-catalyzed double carbonylation reaction of aryl iodides with amine nucleophiles using a stoichiometric amount of CO for α -keto amide syntheses (Scheme 74).⁷⁴ 9-Methylfluorencarbonyl

chloride (COgen) acts as a solid source of CO in a sealed two-chamber glass reactor. Various aryl and heteroaryl iodides showed excellent reactivity and selectivity towards the double carbonylation reaction with various amines, and excellent yields of the α -keto amide derivatives were achieved.

Djakovitch and Dufaud synthesised α -keto amides using covalently immobilized palladium complexes on mesostructured SBA-15 type silica [PdCl₂(PPh₂)₂@SBA-15] (Scheme 75).⁷⁵ It was found that the PdCl₂(PPh₂)₂@SBA-15 catalyst could be reused for up to three cycles without affecting the catalyst performance.

Recently Castillo'n reported the first phosphine-free Pd-catalysed double carbonylation reaction of aryl iodide using Pd/DBU as a catalytic system under atmospheric CO pressure (Scheme 76).⁷⁶ They proved the key roles of DBU were a nucleophile (or acyl transfer agent) and a base. As shown in Scheme 77, in the absence of an amine nucleophile, three new products **61**, **62** and **63** were formed and detected by NMR and MS analysis. These products were the α -keto amide **61** containing a charged DBU unit, and the *cis* and *trans* isomers of the Pd-acyl complex **62**, **63**, respectively. This experiment clearly demonstrated that DBU acts as a nucleophile under these conditions.

Intermediates **62** and **63** can react with a second molecule of CO to form a cationic species **64**, containing a terminal CO group and an acyl moiety with iodide as the counter-ion. At this stage, nucleophilic attack at the terminal CO could occur from the amine nucleophile to directly form Pd-acyl-amide species **65**. Reductive elimination of the complex **65** regenerates the Pd⁰ species and **60**. Papp and Skoda-Földes reported various phosphine-free silica supported palladium catalysts (SILP-Pd) for the double carbonylation reaction of iodobenzene in the presence of secondary amines (Scheme 78).⁷⁷ The catalyst was prepared by impregnating silica with a mixture of a palladium precursor and an ionic liquid (Scheme 79). The catalyst could be recycled at least six times and resulted in excellent yields of the α -keto amides.

5.2 Palladium-catalysed double carbonylation reactions of amines for the synthesis of oxamides

In 1966, Tsuji synthesised oxamides by a palladium catalysed double carbonylation reaction of primary amines for the first time (Scheme 80).⁷⁸ The by-product of hydrogen was confirmed by gas chromatography.

Alper and co-workers have shown palladium catalysed oxidative coupling reactions of amines and carbon monoxide for the synthesis of oxamides and ureas (Scheme 81).⁷⁹ Oxamides were formed in excellent yields when secondary amines were carbonylated in the presence of iodide as a promoter and oxygen. When using primary amides, the selectivity was towards the urea.

The reaction mechanism showed that there were two independent reaction pathways using iodide ligands for the synthesis of oxamides and ureas, respectively (Scheme 82). Palladium acetate can convert to the diiododicarbonyl palladium compound **66** using iodide and carbon monoxide. Displacement of iodide by the amine gives **67**. With complex **67** ligand migration followed by CO insertion takes place to

generate species **68**. Addition of another carbon monoxide molecule generates the ionic species **69**. At this stage amine addition, followed by reductive elimination generates the oxamide **70**. Reoxidation of **71** in the presence of oxygen and the iodide promoter regenerates the active species **66**.

Hiwatari *et al.* developed a new process for converting secondary amines into oxamides under CO pressure, catalyzed by homogeneous palladium complexes in the presence of 1,4-dichloro-2-butene (DCB) **72** as an oxidant (Scheme 83).⁸⁰

The mechanism (Scheme 84) proposes that in the presence of **72**, oxidation of the Pd(0) species readily gives dichloropalladium(II) complex **73**. Complex **73**, upon treatment with CO and diethylamine, forms the monocarbonylpalladium intermediate **74**. Bis(carbamoyl)palladium complex **75**, generated by another CO molecule and amine molecule insertion to species **74**, undergoes reductive elimination to produce the oxamide and regenerate Pd⁰.

5.3 Palladium-catalysed double carbonylation reactions of amines for the synthesis of oxamates

In 1987 Murahashi and co-workers synthesised oxamates by oxidative cross double carbonylation of amines and alcohols using a PdCl₂(MeCN)₂/CuI catalytic system (Scheme 85).⁸¹ The reaction required CuI as a co-catalyst and the dehydrating reagent CH(OMe)₃ under a very high pressure of CO (80 kg cm⁻²) and O₂ (5 kg cm⁻²). In the case of β -aminoalcohols, intramolecular double carbonylation proceeds highly efficiently, giving the corresponding cyclic oxamates (Scheme 86). In this case, addition of the dehydrating reagent CH(OMe)₃ was not necessary.

The mechanism shows that the double carbonylation reaction proceeds *via* the carbamoylpalladium complex **76** or the alkoxycarbonylpalladium complex **77** (Scheme 87). Further coordination of carbon monoxide to **76** or **77** and the subsequent nucleophilic attack of the alcohol or amine gives the alkoxy-carbonylcarbamoylpalladium complex **78**. Reductive elimination of **78** gives the oxamate and PdL₂. PdL₂ is readily oxidized with O₂-CuI-HCl to continue the catalytic cycle.

Recently Gadge and Bhanage used Pd/C as a heterogeneous catalytic system for the synthesis of oxamates (Scheme 88).⁸² The reaction proceeds under a low pressure of CO/O₂ (6 : 1 atm), a short reaction time, and does not require a co-catalyst, base, dehydrating agent or ligand. A variety of amines, such as allylic, benzylic, aliphatic, symmetrical and unsymmetrical amines, underwent cross double carbonylation reactions with alcohols, providing excellent yields of the desired products. Moreover the catalyst was recovered by a simple filtration and reused for up to six consecutive cycles.

6. Conclusions

To summarize, we have reviewed various palladium catalysed carbonylation reactions such as oxidative carbonylation, double carbonylation and several other carbonylative coupling reactions. These reactions provide a novel and efficient tool for constructing various carbonylative compounds. It is necessary to conduct

research towards the synthesis of various heterogeneous catalysts and the development of economical procedures for the synthesis of these heterogeneous catalysts, as this will result in a higher efficiency, selectivity, and a larger substrate scope. Many of these reactions work at high pressure, limiting their application. Future effort needs to be directed towards developing a catalyst which works at atmospheric pressures. There is also a requirement for the deeper understanding of the fundamental aspects of the mechanistic studies of heterogeneous catalysed carbonylation reactions. The catalyst–product separation and the catalyst recyclability in homogeneous catalysis is a major problem and there is a need for the development of various novel strategies to solve this problem. The invention of novel catalyst–product separation techniques and the recovery of precious metal catalysts are current challenges. The development of various biphasic catalysis systems, supported liquid phase catalysis systems, polymer anchored catalysis systems and metal leaching re-deposition techniques for carbonylation reactions have provided attractive ways for process economy and for the overall development of truly ecofriendly reaction methodologies.

Abbreviations

MMC	Methyl <i>N</i> -methylcarbamate
DMU	<i>N,N'</i> -dimethylurea
NMF	<i>N</i> -methylformamide
DPU	<i>N,N'</i> -diphenylurea
DBU	1,8-Diazabicyclo[5.4.0]undec-7-ene
DABCO	1,4-Diazabicyclo[2.2.2]octane
TBAI	Tetrabutylammonium iodide
DMF	Dimethylformamide
MW	Microwave
DCB	1,4-Dichloro-2-butene
TOF	Turnover frequency
TON	Turnover number
DME	Dimethoxyethane
dppfam	[<i>N,N'</i> -bis[(2-diphenylphosphino)phenylformamidinate]
DMA	Dimethylacetamide
phen	1,10-Phenanthroline
DMSO	Dimethyl sulfoxide
dppp	1,3-Bis(diphenylphosphino)propane
dppb	1,4-Bis(diphenylphosphino)butane
pyca	2-Picolinate
BQ	1,4-Benzoquinone
DDQ	2,3-Dichloro-5,6-dicyanobenzoquinone

Acknowledgements

S.T.G. is thankful to CSIR (Council of Scientific and Industrial Research), New Delhi, India for providing a senior research fellowship.

Notes and references

1 (a) B. M. Trost, *Science*, 1991, **254**, 1471–1477; (b) B. M. Trost, *Angew. Chem.*, 1995, **107**, 285; *Angew. Chem., Int. Ed. Engl.*,

1995, **34**, 259–281; (c) B. M. Trost, *Acc. Chem. Res.*, 2002, **35**, 695–705; (d) L. P. Kollar, *Modern Carbonylation Methods*, Wiley-VCH, Weinheim, 2008.

- 2 P. A. Wender and B. L. Miller, *Nature*, 2009, **460**, 197–201.
- 3 (a) P. Anastas and N. Eghbali, *Chem. Soc. Rev.*, 2010, **39**, 301–312; (b) J. J. Song, J. T. Reeves, D. R. Fandrick, Z. Tan, N. K. Yee and C. H. Senanayake, *Green Chem. Lett. Rev.*, 2008, **1**, 141–148; (c) S. Tang, R. Bourne, R. Smith and M. Poliakov, *Green Chem.*, 2008, **10**, 268–269; (d) R. A. Sheldon, *Chem. Commun.*, 2008, 3352–3365; (e) R. A. Sheldon, *Green Chem.*, 2007, **9**, 1273–1283; (f) I. T. Horváth and P. T. Anastas, *Chem. Rev.*, 2007, **107**, 2169–2173; (g) J. A. Dahl, B. L. S. Maddux and J. E. Hutchison, *Chem. Rev.*, 2007, **107**, 2228–2269; (h) P. T. Anastas and M. M. Kirchoff, *Acc. Chem. Res.*, 2002, **35**, 686–694.
- 4 (a) X.-F. Wu, H. Neumann and M. Beller, *ChemSusChem*, 2013, **6**, 229–241; (b) Q. Liu, H. Zhang and A. Lei, *Angew. Chem., Int. Ed.*, 2011, **50**, 10788–10799.
- 5 S. J. Rhoads and R. E. Michel, *J. Am. Chem. Soc.*, 1963, **85**, 585–591.
- 6 (a) R. V. Chaudhari, B. M. Bhanage, R. M. Deshpande and H. Delmas, *Nature*, 1995, **373**, 501–503; (b) B. M. Bhanage and M. Arai, *Catal. Rev.: Sci. Eng.*, 2001, **43**, 315–344.
- 7 A. Molnar, *Chem. Rev.*, 2011, **111**, 2251–2320.
- 8 (a) X.-F. Wu, H. Neumann and M. Beller, *Chem. Soc. Rev.*, 2011, **40**, 4986–5009; (b) X.-F. Wu, H. Neumann and M. Beller, *Chem. Rev.*, 2013, **113**, 1–35; (c) B. Gabriele, R. Mancuso and G. Salerno, *Eur. J. Org. Chem.*, 2012, 6825–6839; (d) A. Brennfuhrer, H. Neumann and M. Beller, *Angew. Chem., Int. Ed.*, 2009, **48**, 4114–4133; (e) R. Grigg and S. P. Mutton, *Tetrahedron*, 2010, **66**, 5515–5548; (f) S. Roy, S. Roy and G. W. Gribble, *Tetrahedron*, 2012, **68**, 9867–9923.
- 9 (a) D. J. Diaz, A. K. Darko and L. McElwee-White, *Eur. J. Org. Chem.*, 2007, 4453–4465; (b) B. Gabriele, G. Salerno, R. Mancuso and M. Costa, *J. Org. Chem.*, 2004, **69**, 4741–4750; (c) P. Giannoccaro, *J. Organomet. Chem.*, 1987, **336**, 271–278; (d) N. D. Ca', P. Bottarelli, A. Dibenedetto, M. Aresta, B. Gabriele, G. Salerno and M. Costa, *J. Catal.*, 2011, **282**, 120–127; (e) K. Orito, M. Miyazawa, T. Nakamura, A. Horibata, H. Ushito, H. Nagasaki, M. Yuguchi, S. Yamashita, T. Yamazaki and M. Tokuda, *J. Org. Chem.*, 2006, **71**, 5951–5958; (f) B. Gabriele, R. Mancuso, G. Salerno and M. Costa, *Chem. Commun.*, 2003, 486–487; (g) H. Alper and F. W. Hartstock, *J. Chem. Soc., Chem. Commun.*, 1985, 1141–1142; (h) W. Tam, *J. Org. Chem.*, 1986, **51**, 2977–2981; (i) B. Gabriele, R. Mancuso, G. Salerno and M. Costa, *J. Org. Chem.*, 2003, **68**, 601–604; (j) B. Gabriele, G. Salerno, D. Brindisi, M. Costa and G. P. Chiusoli, *Org. Lett.*, 2000, **2**, 625–627; (k) Z.-H. Guan, H. Lei, M. Chen, Z.-H. Ren, Y. Bai and Y.-Y. Wang, *Adv. Synth. Catal.*, 2012, **354**, 489–496.
- 10 (a) S. Fukuoka, M. Chono and M. Kohno, *J. Chem. Soc., Chem. Commun.*, 1984, 399–400; (b) S. Fukuoka, M. Chono and M. Kohno, *J. Org. Chem.*, 1984, **49**, 1458–1460.
- 11 A. A. Kelkar, D. S. Kolhe, S. Kanagasabapathy and R. V. Chaudhari, *Ind. Eng. Chem. Res.*, 1992, **31**, 172–176.

- 12 P. Toochinda and S. S. C. Chuang, *Ind. Eng. Chem. Res.*, 2004, **43**, 1192–1199.
- 13 F. Shi, J. Peng and Y. Deng, *J. Catal.*, 2003, **219**, 372–375.
- 14 (a) S. P. Gupte and R. V. Chaudhari, *J. Catal.*, 1988, **114**, 246–258; (b) S. P. Gupte and R. V. Chaudhari, *Ind. Eng. Chem. Res.*, 1992, **31**, 2069–2074.
- 15 M. R. Didgikar, D. Roy, S. P. Gupte, S. S. Joshi and R. V. Chaudhari, *Ind. Eng. Chem. Res.*, 2010, **49**, 1027–1032.
- 16 F. Shi, Y. Deng, T. SiMa and H. Yang, *Tetrahedron Lett.*, 2001, **42**, 2161–2163.
- 17 M. R. Didgikar, S. S. Joshi, S. P. Gupte, M. M. Diwakar, R. M. Deshpande and R. V. Chaudhari, *J. Mol. Catal. A: Chem.*, 2011, **334**, 20–28.
- 18 B. Gabriele, R. Mancuso, G. Salerno and M. Costa, *Top. Organomet. Chem.*, 2006, **18**, 239–271.
- 19 D. J. Diaz, A. K. Darko and L. McElwee-White, *Eur. J. Org. Chem.*, 2007, 4453–4465.
- 20 F. Ragaini, *Dalton Trans.*, 2009, 6251–6266.
- 21 F. Li and C. Xia, *J. Catal.*, 2004, **227**, 542–546.
- 22 (a) B. Gabriele, R. Mancuso, V. Maltese, L. Veltri and G. Salerno, *J. Org. Chem.*, 2012, **77**, 8657–8668; (b) D. N. Briggs, G. Bong, E. Leong, K. Oei, G. Lestari and A. T. Bell, *J. Catal.*, 2010, **276**, 215–228; (c) X. Yang, J. Han, Z. Du, H. Yuan, F. Jin and Y. Wu, *Catal. Commun.*, 2010, **11**, 643–646; (d) B. Gabriele, R. Mancuso, G. Salerno, L. Veltri, M. Costa and A. Dibenedetto, *ChemSusChem*, 2011, **4**, 1778–1786; (e) J. Hu, J. Li, Y. Gu, Z. Guan, W. Mo, Y. Ni, T. Li and G. Li, *Appl. Catal., A*, 2010, **386**, 188–193; (f) J. Hu, Y. Gu, Z. Guan, J. Li, W. Mo, T. Li and G. Li, *ChemSusChem*, 2011, **4**, 1767–1772; (g) F. Doro, P. Winnertz, W. Leitner, A. Prokofieva and T. E. Muller, *Green Chem.*, 2011, **13**, 292–295; (h) D. M. Pearson, N. R. Conley and R. M. Waymouth, *Adv. Synth. Catal.*, 2011, **353**, 3007–3013.
- 23 (a) H. Zhang, R. Shi, P. Gan, C. Liu, A. Ding, Q. Wang and A. Lei, *Angew. Chem., Int. Ed.*, 2012, **51**, 5204–5207; (b) V. Rajeshkumar, T.-H. Lee and S.-C. Chuang, *Org. Lett.*, 2013, **15**, 1468–1471; (c) H. Zhang, D. Liu, C. Chen, C. Liu and A. Lei, *Chem.–Eur. J.*, 2011, **17**, 9581–9585; (d) R. Lang, L. Shi, D. Li, C. Xia and F. Li, *Org. Lett.*, 2012, **14**, 4130–4133; (e) J. W. Wrigglesworth, B. Cox, G. C. Lloyd-Jones and K. I. Booker-Milburn, *Org. Lett.*, 2011, **13**, 5326–5329; (f) X.-F. Wu, H. Neumann and M. Beller, *Chem.–Asian J.*, 2012, **7**, 282–285; (g) A. Behn, J. Zakzeski, M. Head-Gordon and A. T. Bell, *J. Mol. Catal. A: Chem.*, 2012, **361–362**, 91–97; (h) A. R. Elman, *Tetrahedron Lett.*, 2013, **54**, 5527–5531; (i) B. R. Sarkar and R. V. Chaudhari, *Catal. Today*, 2012, **198**, 154–173; (j) Q. Liu, G. Li, J. He, J. Liu, P. Li and A. Lei, *Angew. Chem., Int. Ed.*, 2010, **49**, 3371–3374; (k) H. Chen, C. Cai, X. Liu, X. Li and H. Jiang, *Chem. Commun.*, 2011, **47**, 12224–12226; (l) P. Xie, Y. Xie, B. Qian, H. Zhou, C. Xia and H. Huang, *J. Am. Chem. Soc.*, 2012, **134**, 9902–9905.
- 24 (a) P. Mathur, R. K. Joshi, B. Jha, A. K. Singha and S. M. Mobin, *J. Organomet. Chem.*, 2010, **695**, 2687–2694; (b) B. El Ali, A. El-Ghanam, M. Fettouhi and J. Tijani, *Tetrahedron Lett.*, 2000, **41**, 5761–5764; (c) Y. Izawa, I. Shimizu and A. Yamamoto, *Bull. Chem. Soc. Jpn.*, 2004, **77**, 2033–2045; (d) B. Gabriele, G. Salerno, L. Veltri and M. Costa, *J. Organomet. Chem.*, 2001, **622**, 84–88.
- 25 M.-Z. Cai, C.-S. Song and X. Huang, *Synth. Commun.*, 1997, **27**, 361–366.
- 26 M. Cai, Y. Huang, R. Hu and C. Song, *J. Mol. Catal. A: Chem.*, 2004, **212**, 151–154.
- 27 M. Cai, Y. Huang, R. Hu and C. Song, *J. Mol. Catal. A: Chem.*, 2004, **208**, 17–20.
- 28 M. Cai, H. Zhao and Y. Huang, *J. Mol. Catal. A: Chem.*, 2005, **238**, 41–45.
- 29 C. Csajági, B. Borcsek, K. Niesz, I. Kovacs, Z. Szekelyhidi, Z. Bajko, L. Urge and F. Darvas, *Org. Lett.*, 2008, **10**, 1589–1592.
- 30 J. Salvadori, E. Balducci, S. Zaza, E. Petricci and M. Taddei, *J. Org. Chem.*, 2010, **75**, 1841–1847.
- 31 P. J. Tambade, Y. P. Patil, M. J. Bhanushali and B. M. Bhanage, *Tetrahedron Lett.*, 2008, **49**, 2221–2224.
- 32 F. Zhao, B. M. Bhanage, M. Shirai and M. Arai, *Chem.–Eur. J.*, 2000, **6**, 843–848.
- 33 (a) M. V. Khedkar, S. R. Khan, D. N. Sawant, D. B. Bagal and B. M. Bhanage, *Adv. Synth. Catal.*, 2011, **353**, 3415; (b) M. V. Khedkar, S. R. Khan, K. P. Dhake and B. M. Bhanage, *Synthesis*, 2012, **44**, 2623.
- 34 (a) J. Byun and Y. Lee, *Tetrahedron Lett.*, 2004, **45**, 1837; (b) J. Kim, B. Jun, J. Byun and Y. Lee, *Tetrahedron Lett.*, 2004, **45**, 5827.
- 35 Z. S. Qureshi, S. A. Revankar, M. V. Khedkar and B. M. Bhanage, *Catal. Today*, 2012, **198**, 148–153.
- 36 M. V. Khedkar, T. Sasaki and B. M. Bhanage, *ACS Catal.*, 2013, **3**, 287–293.
- 37 T. T. Dang, Y. Zhu, J. S. Y. Ngiam, S. C. Ghosh, A. Chen and A. M. Seayad, *ACS Catal.*, 2013, **3**, 1406–1410.
- 38 N. P. Reddy, M. L. Kantam and B. M. Choudary, *Indian J. Chem., Sect. B: Org. Chem. Incl. Med. Chem.*, 1989, **28**, 105.
- 39 M.-Z. Cai, C.-S. Song and X. Huang, *J. Chem. Soc., Perkin Trans. 1*, 1997, 2273–2274.
- 40 C. Ramesh, R. Nakamura, Y. Kubota, M. Miwa and Y. Sugi, *Synthesis*, 2003, **4**, 501–504.
- 41 J. Liu, J. Chen and C. Xia, *J. Catal.*, 2008, **253**, 50–56.
- 42 I. P. Beletskaya and O. G. Ganina, *React. Kinet., Mech. Catal.*, 2010, **99**, 1–4.
- 43 S. T. Gadge, M. V. Khedkar, S. R. Lanke and B. M. Bhanage, *Adv. Synth. Catal.*, 2012, **354**, 2049–2056.
- 44 S. T. Gadge and B. M. Bhanage, *Synlett*, 2013, **24**, 0981–0986.
- 45 (a) T. Ishiyama, H. Kizaki, T. Hayashi, A. Suzuki and N. Miyaura, *J. Org. Chem.*, 1998, **63**, 4726–4731; (b) S. Shi and Y. Zhang, *Synlett*, 2007, 1843; (c) P.-H. Li and L. Wang, *Adv. Synth. Catal.*, 2006, 348–681.
- 46 (a) M. S. M. Ahmed and A. Mori, *Org. Lett.*, 2003, **5**, 3057–3060; (b) S. K. Kang, K. H. Lim, P. S. Ho and W. Y. Kim, *Synthesis*, 1997, 874; (c) T. Kobayashi and M. J. Tanaka, *J. Chem. Soc., Chem. Commun.*, 1981, 333; (d) S. Bonnaire, J. F. Carpentier, A. Mortreux and Y. Castanet, *Tetrahedron Lett.*, 2001, **42**, 3689–3691; (e) E. Maerten, F. Hassouna, S. Bonnaire, A. Mortreux, J. F. Carpentier and Y. Castanet, *Synlett*, 2003, **12**, 1874–1876.
- 47 P. J. Tambade, Y. P. Patil, A. G. Panda and B. M. Bhanage, *Eur. J. Org. Chem.*, 2009, 3022–3025.

- 48 M. V. Khedkar, P. J. Tambade, Z. S. Qureshi and B. M. Bhanage, *Eur. J. Org. Chem.*, 2010, 6981–6986.
- 49 Z. Qureshi, K. M. Deshmukh, P. J. Tambade and B. M. Bhanage, *Synthesis*, 2011, 2, 243–250.
- 50 M. V. Khedkar, T. Sasaki and B. M. Bhanage, *RSC Adv.*, 2013, 3, 7791–7797.
- 51 H. Li, M. Yang, Y. Qi and J. Xue, *Eur. J. Org. Chem.*, 2011, 2662–2667.
- 52 M. Cai, J. Peng, W. Hao and G. Ding, *Green Chem.*, 2011, 13, 190–196.
- 53 J.-R. Niu, X. Huo, F.-W. Zhang, H.-B. Wang, P. Zhao, W.-Q. Hu, J. Ma and R. Li, *ChemCatChem*, 2013, 5, 349–354.
- 54 J. Liu, J. Chen and C. Xia, *J. Catal.*, 2008, 253, 50–56.
- 55 J. Liu, X. Peng, W. Sun, Y. Zhao and C. Xia, *Org. Lett.*, 2008, 10, 3933–3936.
- 56 Y. Wang, J. Liu and C. Xia, *Tetrahedron Lett.*, 2011, 52, 1587–1591.
- 57 (a) W. Hao, J. Sha, S. Sheng and M. Cai, *J. Mol. Catal. A: Chem.*, 2009, 298, 94–98; (b) M. Genelot, V. Dufaud and L. Djakovitch, *Adv. Synth. Catal.*, 2013, 355, 2604–2616.
- 58 (a) S. J. Rhoads and R. E. Michel, *J. Am. Chem. Soc.*, 1963, 85, 585–591; (b) E. P. Burrows and D. H. Rosenblatt, *J. Org. Chem.*, 1982, 47, 892–893; (c) R. Peters, M. Althaus and A.-L. Nagy, *Org. Biomol. Chem.*, 2006, 4, 498–509; (d) F. A. Cotton, C. Y. Liu, C. A. Murillo, D. Villagran and X. Wang, *J. Am. Chem. Soc.*, 2003, 125, 13564–13575.
- 59 J. T. Chen and A. Shen, *J. Am. Chem. Soc.*, 1984, 106, 1506.
- 60 T. Kobayashi and M. Tanaka, *J. Organomet. Chem.*, 1982, 233, C64–C66.
- 61 F. Ozawa, H. Soyama, T. Yamamoto and A. Yamamoto, *Tetrahedron Lett.*, 1982, 23, 3383–3386.
- 62 (a) F. Ozawa, H. Soyama, H. Yanagihara, I. Aoyama, H. Takino, K. Izawa, T. Yamamoto and A. Yamamoto, *J. Am. Chem. Soc.*, 1985, 107, 3235–3245; (b) F. Ozawa, H. Yanagihara and A. Yamamoto, *J. Org. Chem.*, 1986, 51, 415–417.
- 63 T. Satoh, K. Kokubo, M. Miura and M. Nomura, *Organometallics*, 1994, 13, 4431.
- 64 Y.-Y. Yan, H.-P. Zuo and Z.-L. Jin, *React. Funct. Polym.*, 1997, 32, 21–24.
- 65 S. Couve-Bonnaire, J.-F. Carpentier, Y. Castanet and A. Mortreux, *Tetrahedron Lett.*, 1999, 40, 3717–3718.
- 66 Y. Uozumi, T. Arie and T. Watanabe, *J. Org. Chem.*, 2001, 66, 5272–5274.
- 67 N. Tsukada, Y. Ohba and Y. Inoue, *J. Organomet. Chem.*, 2003, 687, 436–443.
- 68 M. Izuka and Y. Kondo, *Chem. Commun.*, 2006, 1739–1741.
- 69 Md. T. Rahman, T. Fukuyama, N. Kamata, M. Sato and I. Ryu, *Chem. Commun.*, 2006, 2236–2238.
- 70 E. R. Murphy, J. R. Martinelli, N. Zaborenko, S. L. Buchwald and K. F. Jensen, *Angew. Chem., Int. Ed.*, 2007, 46, 1734–1737.
- 71 C. Csajági, G. Szatzker, E. R. Toke, L. Üрге, F. Darvas and L. Poppe, *Tetrahedron: Asymmetry*, 2008, 19, 237–246.
- 72 J. Balogh, Á. Kuik, L. Üрге, F. Darvas, J. Bakos and R. Skoda-Földes, *J. Mol. Catal. A: Chem.*, 2009, 302, 76–79.
- 73 J. Liu, S. Zheng, W. Sun and C. Xia, *Chin. J. Chem.*, 2009, 27, 623–627.
- 74 D. U. Nielsen, K. Neumann, R. H. Taaning, A. T. Lindhardt, A. Modvig and T. Skrydstrup, *J. Org. Chem.*, 2012, 77, 6155–6165.
- 75 M. Genelot, N. Villandier, A. Bendjeriou, P. Jaithong, L. Djakovitch and V. Dufaud, *Catal. Sci. Technol.*, 2012, 2, 1886–1893.
- 76 V. de la Fuente, C. Godard, E. Zangrando, C. Claver and S. Castillo'n, *Chem. Commun.*, 2012, 48, 1695–1697.
- 77 M. Papp and R. Skoda-Földes, *J. Mol. Catal. A: Chem.*, 2013, 378, 193–199.
- 78 J. Tsuji and N. Iwamoto, *Chem Commun.*, 1966, 380.
- 79 I. Pri-Bar and H. Alper, *Can. J. Chem.*, 1990, 68, 1544–1547.
- 80 K. Hiwatari, Y. Kayaki, K. Okita, T. Ukai, I. Shimizu and A. Yamamoto, *Bull. Chem. Soc. Jpn.*, 2004, 77, 2237–2250.
- 81 (a) S.-I. Murahashi, Y. Mitsue and K. Ike, *J. Chem. Soc., Chem. Commun.*, 1987, 125–127; (b) Y. Imada, Y. Mitsue, K. Ike, K.-I. Washizuka and S.-I. Murahashi, *Bull. Chem. Soc. Jpn.*, 1996, 69, 2079–2090.
- 82 S. T. Gadge and B. M. Bhanage, *J. Org. Chem.*, 2013, 78, 6793–6797.