

Sustainable Energy & Fuels

Interdisciplinary research for the development of sustainable energy technologies

rsc.li/sustainable-energy



ISSN 2398-4902



Cite this: *Sustainable Energy Fuels*,
2020, 4, 4482

Rock 'n' use of CO₂: carbon footprint of carbon capture and utilization by mineralization†

Hesam Ostovari, ^a André Sternberg ^{‡a} and André Bardow ^{*ab}

A recent approach to reduce the carbon footprint of industries with process-inherent CO₂ emissions is CO₂ mineralization. Mineralization stores CO₂ by converting it into a thermodynamically stable solid. Beyond storing CO₂, the products of CO₂ mineralization can potentially substitute conventional products in several industries. Substituting conventional production increases both the economic and the environmental potential of carbon capture and utilization (CCU) by mineralization. The promising potential of CO₂ mineralization is, however, challenged by the high energy demand required to overcome the slow reaction kinetics. To provide a sound assessment of the climate impacts of CCU by mineralization, we determine the carbon footprint of CCU by mineralization based on life cycle assessment. For this purpose, we analyze 7 pathways proposed in literature: 5 direct and 2 indirect mineralization pathways, considering serpentine, olivine, and steel slag as feedstock. The mineralization products are employed to partially substitute cement in blended cement. Our results show that all considered CCU technologies for mineralization could reduce climate impacts over the entire life cycle based on the current state-of-the-art and today's energy mix. Reductions range from 0.44 to 1.17 ton CO_{2e} per ton CO₂ stored. To estimate an upper bound on the potential of CCU by mineralization, we consider an ideal-mineralization scenario that neglects all process inefficiencies and utilizes the entire product. For this ideal mineralization, mineralization of 1 ton CO₂ could even avoid up to 3.2 times more greenhouse gas emissions than only storing CO₂. For all mineralization pathways, the carbon footprint is mainly reduced due to the permanent storage of CO₂ and the credit for substituting conventional products. Thus, developing suitable products is critical to realize the potential benefits in practice. Then, carbon capture and utilization by mineralization could provide a promising route for climate change mitigation.

Received 4th February 2020
Accepted 26th February 2020

DOI: 10.1039/d0se00190b

rsc.li/sustainable-energy

1. Introduction

Global anthropogenic greenhouse gas (GHG) emissions need to become zero and even negative in order to contain the negative impacts of climate change.^{1,2} A key technology to reduce greenhouse gas emissions is renewable energy. Renewable energy avoids GHG emissions by substituting fossil energy. However, energy substitution is not sufficient for industries with process-inherent CO₂ emissions such as the cement and steel industry. The cement industry contributes 7% to the global GHG emissions with 2.2 Gt CO_{2e} per year in 2014.³ E.g., China's GHG emissions from cement production (approximately 1 Gt CO_{2e} per year) are higher than the total GHG emissions from Germany (0.87 Gt CO_{2e} per year in 2018).^{4,5} The IEA thus requires that the cement industry should cumulatively reduce

GHG emissions by 7.7 Gt CO_{2e} by 2060 to achieve the 2 °C goal, despite increase in global cement production.³ After the cement industry, the steel industry is the second largest industrial contributor to global GHG emissions with 5% and 2.1 Gt CO_{2e} per year in 2017. For the steel industry, the IEA recommends 10 Gt CO_{2e} cumulative emission reductions by 2060.⁶

Currently, the only technology to reduce process-inherent CO₂ emissions is carbon capture and storage (CCS).⁷ A variety of technologies are available for both CO₂ capture and storage. To store the captured carbon dioxide, two approaches are currently discussed: geological storage and mineralization.^{8,9} For geological storage, the captured CO₂ is compressed and pumped underground. Several storage projects are currently running to demonstrate and develop the required technologies for storage itself but also for the monitoring, safety, and social acceptance.^{10,11}

In carbon capture and storage by mineralization, CO₂ is stored by conversion into a thermodynamically stable solid. For this purpose, CO₂ reacts with metal-oxide-bearing materials MO such as magnesium oxide or calcium oxide to produce carbonates MCO₃, which are stable for geological timeframes (over millions of years):

^aInstitute of Technical Thermodynamics, RWTH Aachen University, Aachen, Germany.
E-mail: andre.bardow@ltt.rwth-aachen.de

^bInstitute of Energy and Climate Research, Energy Systems Engineering (IEK-10),
Forschungszentrum Jülich GmbH, Jülich, Germany

† Electronic supplementary information (ESI) available. See DOI:
10.1039/d0se00190b

‡ Present address: Fraunhofer Institute for Solar System, Freiburg, Germany.



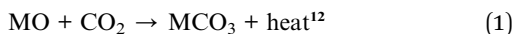

The mineralization reaction (1) is thermodynamically favorable (exergonic) and already occurs in nature. However, the mineralization reaction is challenging due to its slow reaction kinetics. To overcome the slow reaction kinetics, high reaction pressures and temperatures have been recommended¹³ as well as mechanical and thermal pretreatment of feedstock^{14–16} and a variety of reaction additives.¹⁷

While mineralization has already been intensively discussed for carbon capture and storage,⁹ more recently, the potential utilization of the mineralization products has been gaining attention.¹⁸ This shift leads to a new approach: carbon capture and utilization (CCU) by mineralization. CCU by mineralization retains the benefits of CCS by mineralization but additionally yields value-added products. Value-added products increase the economic potential of CCU by mineralization through additional revenues and increase the environmental benefits of CCU by mineralization through the substitution of conventional production.

The promising potential of mineralization is challenged by the energy required to overcome the slow reaction kinetics. Thus, most available mineralization studies discuss energy consumption.^{13,14,19–27} However, to confirm the environmental benefits of CCU by mineralization, a comprehensive and systematic assessment of environmental impacts is required. Life Cycle Assessment (LCA) is a systematic method to assess the environmental impacts of processes by taking into account the entire life cycle of the product from raw material extraction until the final waste disposal.²⁸ Thereby, LCA avoids problem shifting between life-cycle stages or between environmental impacts.²⁸

For carbon capture and storage, a number of LCA studies have already been performed for CO₂ mineralization. Giannoulakis *et al.*²⁹ performed a LCA study for a power plant and showed that the implementation of CCS by mineralization could reduce life cycle GHG emissions by 15–64% but would increase the levelized cost of electricity by 90–370% compared to a reference power plant without CCS. Xiao *et al.*³⁰ studied the mineralization of steel slag *via* several pathways and showed that key factors effecting the overall process are the particle size of alkaline solid waste, the rotating speed of the rotary packed bed, the solid/liquid ratio, and the reaction temperature. In another LCA study, Julcour *et al.*³¹ investigated the effect of mechanical exfoliation on mineralization to reduce emissions from a power plant. A reduction of the overall GHG emissions was reached but the additional energy consumption required for the process increased other environmental impacts. Ncongwane *et al.*³² compared the potential of six mineralization processes with pyroxene minerals (platinum group metal tailings) as feedstock to reduce GHG emissions and showed that all processes cause more GHG emissions than they avoid. The study concluded that environmentally beneficial mineralization processes require higher reaction conversions and lower energy demand. Khoo *et al.*³³ simulated a dry mineralization pathway and performed a preliminary life cycle assessment. The authors showed that the mineralization pathway can avoid GHG emission; however, confirmation of the results requires experimental studies that have been hindered “due to various engineering limitations”. In another study, Khoo *et al.*³⁴ applied

LCA to investigate mineralization for land reclamation in Singapore and demonstrate that mineralization has the potential to reduce GHG emissions. To further increase benefits from mineralization, process energy demand should be reduced. Nduagu *et al.*³⁵ compared two mineralization pathways to reduce emissions from a power plant and showed that mineralization of 1 ton CO₂ from coal power plant could avoid between 317–483 kg CO_{2e}. Cuéllar-Franca *et al.*³⁶ analyzed the results of Khoo *et al.*^{33,34} and Nduagu *et al.*³⁵ in their review of LCA studies and concluded that the GHG emission reduction of mineralization is sensitive to CO₂ capture, allocation methods and assumptions for heat recovery. Cuéllar-Franca *et al.*³⁶ also point to the potential utilization of mineralization products but the impacts associated with utilization were not considered in the LCA yet.

As mentioned above, recently, the perspective is changing from mineralization for CO₂ storage to CO₂ utilization for value-added products. In a LCA study, Kelly *et al.*³⁷ evaluated a brine mineralization plant including utilization of mineralization products such as sodium bicarbonate but concluded that this caustic pathway needs to overcome several challenges such as the energy demand of sodium hydroxide production and the generation of potentially hazardous wastes in form of chlorine or hydrogen chloride. Oh *et al.*³⁸ investigated the combination of a caustic mineralization with brackish water desalination. The brackish water desalination rejects sodium ions that react with CO₂ in caustic mineralization to produce sodium bicarbonate. The authors performed a ‘cradle-to-gate’ LCA and concluded that the suggested process is not competitive against carbon capture and geological storage when coal-based electricity is used. Kirchofer *et al.*³⁹ investigated environmental impacts of alkalinity sources on the life cycle energy efficiency of mineralization pathways including the utilization of mineralization products as aggregate for concrete production. The results showed that reaction yield, heating, mixing, and grinding are environmental hot-spots, and for a better comparison, detailed simulation of processes is necessary. Pan *et al.*⁴⁰ investigated the engineering, environmental, and economic performance of a rotary packed-bed reactor for mineralization of steel slag. The mineralization product is used in the cement industry. These authors showed that the environmental impacts can be substantially reduced by up to 1279 kg CO_{2e} per ton steel slag. Ghasemi *et al.*⁴¹ performed a LCA study of slurry and wet mineralization pathways of basic oxygen furnace slag. The mineralization product is used as building material. These authors concluded that both pathways are capable of storing CO₂ and reducing GHG emissions. In a recent LCA study, Di Maria *et al.*⁴² compared the environmental impacts of construction blocks from carbonated steel slag with block based on Portland cement. The study showed that the blocks from carbonated steel slag can potentially reduce GHG emission in comparison to blocks based on Portland cement. However, the market for steel slag is limited and other sources for production of carbonated construction blocks should be investigated.

The mentioned LCA studies yield important insights on the specific processes studied. However, the studies are difficult to compare and lead to inconsistent conclusions due to different assumptions, system boundaries, and life cycle stages in the LCA analysis.



In this work, we present a method for consistent life cycle assessment of carbon capture and utilization by mineralization (Section 2). The life cycle assessment method is then employed for the 7 main pathways for CCU by mineralization currently discussed in literature, described in Section 3, to calculate their carbon footprint (Section 4). In a state-of-the-art scenario, we illustrate the current status of CCU by mineralization to reduce carbon footprint (Section 4.2). An ideal-mineralization scenario is studied upper bound for the potential reductions by CCU by mineralization (Section 4.3). From this analysis, we identify hot-spots for further investigations (Section 4.4).

Our results show that state-of-the-art CCU by mineralization could reduce carbon footprint by up to 1.17 ton CO_{2e} per ton CO₂ stored based on current technologies. For an ideal-mineralization scenario, carbon footprint could even be reduced by up to 3.2 ton CO_{2e} per ton CO₂ stored. Thus, CCU by mineralization could reduce carbon footprint by more than 1 ton CO_{2e} per ton CO₂ stored and could thus reduce the carbon footprint more than CCS. The increased benefits are due to the fact that CCU by mineralization both stores CO₂ and substitutes conventional products.

2. LCA method

Life cycle assessment is a well-established method to analyze the environmental impacts of products and processes.²⁸ LCA is standardized in ISO 14040/14044.^{43,44} The ISO standard divides LCA into 4 phases: (1) goal & scope definition; (2) life cycle inventory (LCI) analysis; (3) life cycle impact assessment; (4) interpretation. In the following, we specify the 4 LCA phases and derive our LCA method for carbon capture and utilization by mineralization.

2.1. Goal & scope definition

The first phase of LCA states the goal (reason) and the scope (conditions and assumptions) of the study.

Functional unit for CCU by mineralization. In LCA, the basis for comparison is called functional unit (FU) and is a quantitative measure for providing a function with a certain performance. All results in LCA are presented with respect to the functional unit.²⁸ For carbon capture and utilization by mineralization, we identify 4 potential functional units (see the ESI, Section S1†). The goal of the present study is to compare the climate impacts of technologies for CCU by mineralization and to benchmark them to the maximum potential of carbon capture and storage (CCS). We therefore choose a functional unit of 1 ton of stored CO₂. This functional unit allows us to compare mineralization pathways yielding different products on a consistent basis. At the same time, our results can be easily compared to previous studies on mineralization and other CCS technologies.

System boundary for CCU by mineralization. The scope of a LCA study is captured by the system boundary. A comparative LCA study of mineralization pathways for utilization should include all life cycle stages from feedstock supply to the use stage where the mineralization product substitutes a conventional product (Fig. 1). The remaining life cycle can then be assumed to

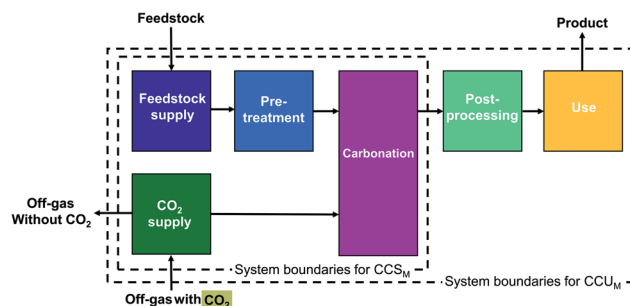

Fig. 1 System boundaries of carbon capture and utilization by mineralization (CCU_M) and carbon capture and storage by mineralization (CCS_M).

be identical for the mineralization and the conventional products. The feedstock (rich in magnesium oxide or calcium oxide) enters the system and passes through “Feedstock supply” and “Pretreatment” stages to “Carbonation” where it reacts with CO₂, which comes from the “CO₂ supply” stage. In contrast to mineralization for CO₂ storage, CO₂ utilization sends the carbonation products to “Post-processing” and “Use” stages. “Post-processing” includes all processes to prepare the product for the desired application. In the “Use stage”, the mineralization product substitutes a conventional product. Products from CO₂ mineralization have been shown to be useable for a variety of applications (see the ESI, Section S2†). In our study, we consider blended cement as potential product, where CO₂ mineralization products serve as cement substitutes to replace conventional cement.⁴⁵ Blended cement offers a large market size in the gigaton scale with a good price. The life cycle stages are discussed in more detail in Section 3.1 and in the ESI, Section S2.†

Our definition of the functional units makes any CCU technology inherently multi-functional: on the one hand, a CCU technology fulfills the function specified in the functional unit, *i.e.*, storing CO₂; on the other hand, the CCU technology has the function to produce a value-added product. Multi-functionality requires special treatment in LCA to distribute the environmental impacts to the different functions. General LCA guidelines such as the ISO norm,⁴³ ILCD handbook,²⁸ and CCU-specific guidelines⁴⁶ recommend to include all functions in the functional unit (system expansion). However, system expansion does not allow to compute product-specific footprints. To be able to report technology-specific environmental impacts, we employ system expansion *via* substitution (avoided burden). For comparative LCAs, the avoided burden approach is mathematically equivalent to system expansion, since the same changes in environmental impacts are computed.⁴⁷ In the avoided-burden approach, we subtract the avoided impacts from additional functions.²⁸

For CCU by mineralization, the expanded system (Fig. 2a) includes of course the mineralization plant that captures CO₂ and produces the cement substitute. In this work, the CO₂ for the mineralization plant is provided by a steel plant. Therefore, the steel plant is also included in the expanded system. Furthermore, the mineralization products partially substitute cement. To capture this substitution effect, a cement plant is also included in the expanded system. Thus, the functions of



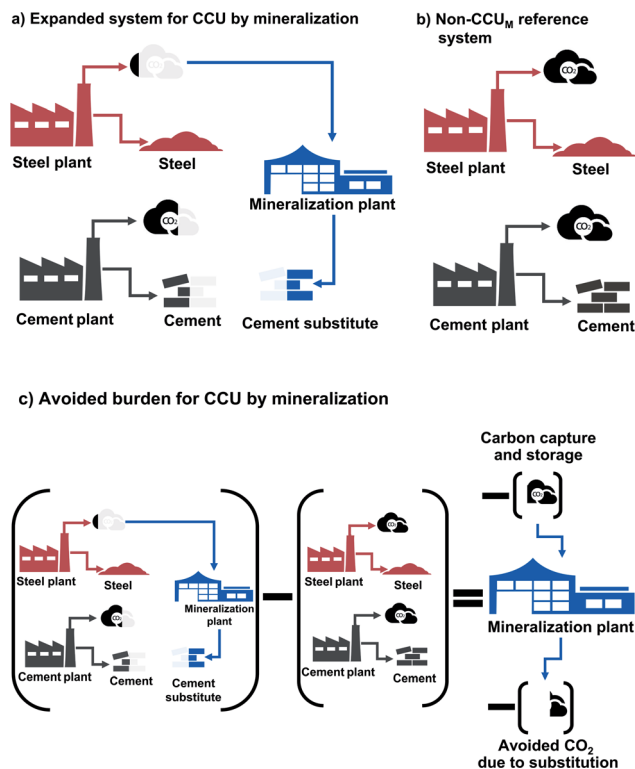

Fig. 2 Definition of avoided burden for carbon capture and utilization by mineralization (CCU_M). "a" shows system expansion for CCU_M (blue) which includes the CO_2 -source (steel plant, red) and the substituted cement plant (black) inside the system boundary. "b" shows the non- CCU_M reference system, which has the same functions as the expanded system for CCU_M but without the CCU_M plant. In "c", the non- CCU_M reference system is subtracted from the expanded system to calculate the avoided burden for CCU by mineralization.

the expanded system are: storage of CO_2 , as well as the production of both steel and cement. To determine the avoided impacts from the functions beyond CO_2 storage, we define a reference system with the same additional functions but without CCU by mineralization (non- CCU_M). In our case, the reference system is the steel plant without CO_2 capture and the conventional cement plant (Fig. 2b). To calculate the avoided burden (Fig. 2c), we subtract the non- CCU_M reference system from the expanded system. The resulting reductions in CO_{2e} emissions are thus due to the capture and storage of CO_2 from the steel plant and due to the substitution of conventional cement. The resulting carbon footprint represents a comparison between the CCU system and the reference system. A negative carbon footprint thus indicates that the CCU system has less CO_{2e} emissions than the reference system.

2.2. Life cycle inventory (LCI)

The second phase of LCA is the life cycle inventory where we collect all mass and energy balances to compute the flows to and from the environment. A general description of the processes inside each life cycle stage is given in the ESI, Section S2.† The specific process data employed in this study is discussed together with the process descriptions in Section 3.

An important stage in the life cycle for CCU is the use stage. As discussed in Section 2.1, we assume for the use stage that the value-added mineralization product from CCU substitutes a conventional product. Hereby, we need to account for the fact that the feedstock of mineralization is usually not 100% pure magnesium oxide or calcium oxide but rather a natural mineral or a waste with high percentage of silicon.⁴⁸ As a result, products of mineralization are carbonates plus silicates. In our case study, mineralization products can be mixed with Ordinary Portland Cement (OPC) to produce blended cement. Thus, mineralization products partially substitute ordinary Portland cement.⁴⁵ The blended cement with the mineralization products has been shown to fulfill cement standards (e.g., ASTM C150 standard).⁴⁹

Still, the blended cement has also been shown to reduce performance for some applications:⁴⁵ Benhelal *et al.*⁴⁵ showed that blended cement with 10% silicon dioxide (SiO_2) from mineralization has approximately 95% of the performance of pure ordinary Portland cement. The substitution credit considered in our study is thus 95% of the environmental impact due to production of ordinary Portland cement.

Apart from its own performance, the substitution credit could also be affected by other parameters such as alternative substitution materials or market size.^{46,50} Due to the uncertainty of these parameters for the considered novel products from CCU by mineralization, we analyze these parameters in Section 4.4.

2.3. Life cycle impact assessment (LCIA)

The third phase of LCA, the life cycle impact assessment, translates the flows from and to the environment determined in the life cycle inventory into environmental impacts such as climate change, fossil resource depletion, and toxicity. Since the main motivation of CO_2 mineralization is the reduction of GHG emissions, we focus on impacts on climate change for our study. The climate change impact is determined according to IPCC following the recommendations for Life Cycle Assessment of the European Commission.²⁸ To express the climate change impacts, we use the standardized methodology of carbon footprinting.⁵¹ The reason for limiting this first study to a single environmental impact is that reductions in climate change impacts are the most critical requirement for CO_2 mineralization to be environmentally reasonable. However, other impact categories should be analyzed to assess all environmental impacts of CO_2 mineralization.

2.4. Interpretation

In the fourth phase of LCA, the life cycle inventory and/or life cycle impact assessment results are interpreted, and uncertainties are investigated.²⁸ Interpretation of our results is provided in Section 4.4.

3. Life cycle inventory of CO_2 mineralization pathways

To specify the life cycle inventories of our study, first we describe the considered mineralization pathways in detail



(Section 3.1). In Section 3.2, we describe the employed life cycle inventory data and our scenarios for the LCA calculation.

3.1. Process description of pathways for carbon capture and utilization by mineralization

LCA requires data on the complete pathway from resource extraction to the final product and use stage. In literature, the focus is mostly on the mineralization reactions themselves and often the studies do not include the entire pathway. In this work, we extract 7 mineralization pathways from published studies and close the process and/or data gaps to perform a comparative LCA. In particular, we consider 2 direct mineralization concepts (with 5 pathways) and 2 indirect mineralization concepts (with 2 pathways). Simply put, direct mineralization concepts directly react CO₂ with the feedstock in one step, whereas indirect mineralization breaks the process into multiple steps.

(a) Direct concepts

Continuously stirred tank reactor pathways (CSTR pathways).

This direct concept uses a continuously stirred tank reactor (CSTR) for mineralization.¹³ The pretreatment and the reaction conditions depend on the feedstock, which allows us to divide the CSTR pathways into two categories depending on their respective feedstock serpentine and olivine.

In the olivine pathways (Fig. 3), olivine is mined, crushed, and transported to the mineralization plant. In the pretreatment stage, olivine is prepared *via* grinding and milling. In the following carbonation stage, the powdered olivine is first mixed with water and additives, and subsequently reacted with CO₂ from the CO₂ supply. The products are transferred to the post-processing stage, where they are separated and dewatered. The solution of water and additives is recycled to the carbonation stage, and the products continue to the use stage. In the use stage, the products substitute ordinary Portland cement.

The serpentine pathways (Fig. 4) are identical to the olivine pathways except for the pretreatment stage. As pretreatment, serpentine is first grinded, then iron is separated *via* magnet separation. Afterwards, the grinded serpentine is activated *via* heat treatment.

The main benefit of the CSTR pathways is the simple flow-sheet which makes scale-up easy. The CSTR pathways have been

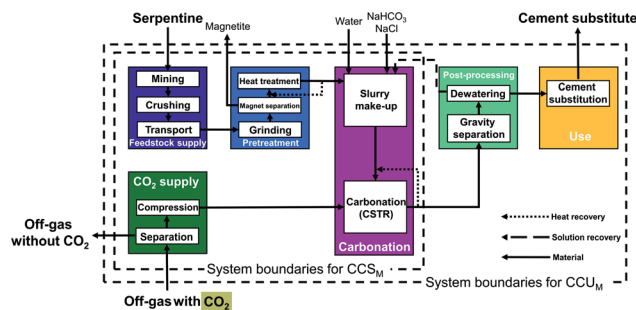

Fig. 4 Process flow diagram of carbon capture and utilization by mineralization *via* direct mineralization in CSTR using serpentine (pathways CSTR 150 bar and CSTR 10 bar; pathway CSTR 10 bar does not require CO₂ separation). CCS_M is carbon capture and storage by mineralization. CCU_M is carbon capture and utilization by mineralization.

improved using various additives, pretreatments, and reactor conditions (pressure, temperature, reaction time, stirring speed).^{13,52–55} For CSTR pathways using serpentine as feedstock, we consider the pathway based on O'Connor *et al.*¹³ using pure CO₂ at 115 bar (CSTR 115 bar serpentine) and the pathway based on Kemache *et al.*²² using directly off-gas that is compressed to 10 bar for the mineralization (CSTR 10 bar serpentine). For olivine as feedstock, we consider the pathway based on O'Connor *et al.*¹³ using pure CO₂ at 150 bar (CSTR 150 bar olivine) and the pathway based on Eikeland *et al.*⁵³ using pure CO₂ at 100 bar (CSTR 100 bar olivine).

Rotary packed bed pathway (RPB pathway). This direct concept uses a rotary packed bed (RPB) for mineralization. The rotary packed bed pathway commonly employs steel slag as feedstock.⁵⁶

In the rotary packed bed pathway (Fig. 5), steel slag is first crushed and then transported to the mineralization plant. No mining is required since steel slag is a by-product of the steel industry.⁶¹ Next, the steel slag is grinded in the pretreatment stage and mixed with water (or wastewater) in the carbonation stage to produce a suspension. The suspension enters the reactor and reacts with the CO₂ directly from the off-gas. In the following post-processing stage, the products are dewatered,

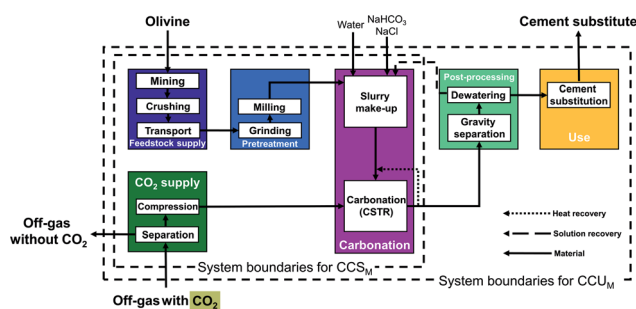

Fig. 3 Process flow diagram of carbon capture and utilization by mineralization *via* direct mineralization in CSTR using olivine (pathways CSTR 150 bar and CSTR 100 bar). CCS_M is carbon capture and storage by mineralization. CCU_M is carbon capture and utilization by mineralization.

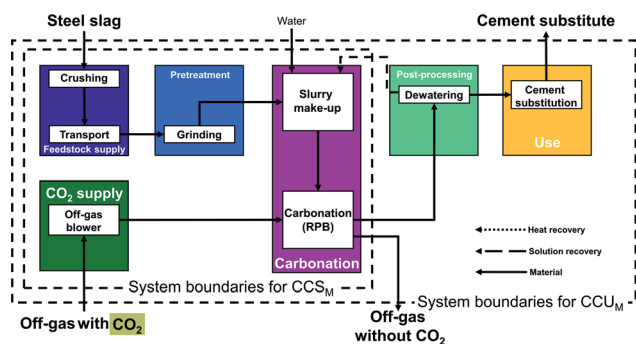

Fig. 5 Process flow diagram of carbon capture and utilization by mineralization *via* direct mineralization in rotary packed bed reactor (RPB) using steel slag. CCS_M is carbon capture and storage by mineralization. CCU_M is carbon capture and utilization by mineralization.



and the recovered solution is recycled to the carbonation stage. Finally, the dewatered products substitute ordinary Portland cement in the use stage. The benefits of the rotary packed bed pathway are the atmospheric conditions of the reactor (pressure, temperature) and the possibility to directly employ off-gas with 15–20% CO₂ instead of pure CO₂, which can lower the energy demand. For our study, we consider the pathway based on Pan *et al.*⁵⁷

(b) Indirect concepts

Abo Academy pathway (AA pathway). This indirect concept has two main steps: first, solid/solid extraction and then carbonation in a fluidized bed. The feedstock of the Abo Academy pathway is serpentine. In the Abo Academy pathway (Fig. 6), the feedstock supply and pretreatment stage are identical to the CSTR pathways with serpentine (*cf.* Fig. 4), *i.e.*, serpentine is mined, crushed, transported, grinded, magnetically separated, and treated by heat. In the carbonation stage, the activated serpentine is first reacted with ammonium sulfate ((NH₄)₂SO₄) in a solid/solid extraction. The products are transferred to an aqueous leaching process where water is added and magnesium is leached. The aqueous leaching process splits the process streams: residues and silicon dioxide (SiO₂) are dewatered in the post-processing stage. The solution is recycled to the carbonation stage, and the silicon dioxide (SiO₂) is transferred to use stage. Ammonium sulfate ((NH₄)₂SO₄) in aqueous solution is sent to reagent recovery, where the ammonium sulfate is crystallized and separated from the solution. The ammonium sulfate in solid phase is reused in the solid/solid extraction.

The leached magnesium is sent to the carbonation process. In the carbonation process, the leached magnesium reacts with the CO₂ from the CO₂ supply stage in a gas/solid reactor (fluidized bed) to produce carbonates. The carbonates are separated in the post-processing stage and transferred to the use stage. In the use stage, products are mixed (if required) and substitute ordinary Portland cement.

The advantage of the Abo Academy pathway is the production of separated and very pure products in each step, which avoids separation processes. For our study, we consider the pathway based on Fagerlund *et al.*^{58,59}

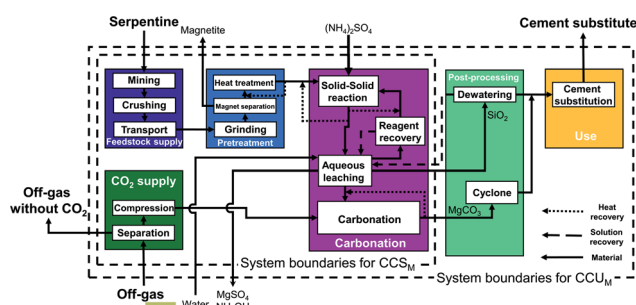

Fig. 6 Process flow diagram of carbon capture and utilization by mineralization via indirect concept of the Abo Academy pathway (AA pathway) using serpentine. Carbonation takes place in a fluidized bed (FB). CCS_M is carbon capture and storage by mineralization. CCU_M is carbon capture and utilization by mineralization.

Nottingham pathway. This indirect concept also proceeds in two steps: first, aqueous extraction and then aqueous carbonation. The Nottingham pathway commonly employs serpentine as feedstock. In the Nottingham pathway (Fig. 7), the feedstock supply and the pretreatment stage are thus also identical to the CSTR pathways with serpentine (*cf.* Fig. 4) with the exception of the heat pretreatment: no heat pretreatment is required in the Nottingham pathway. Serpentine is mined, crushed, transported, grinded, and magnetically separated. In the carbonation stage, the grinded serpentine is first reacted with ammonium bisulfate (NH₄HSO₄) in the aqueous extraction step to produce a magnesium-rich solution and silicon dioxide (SiO₂). The magnesium-rich solution and the silicon dioxide are then further processed separately:

Silicon dioxide (SiO₂) is transferred to the post-processing stage, where it is dewatered. The solution is recycled to reagent recovery, and silicon dioxide (SiO₂) is transferred to the use stage.

The magnesium-rich solution is transferred to the pH-adjustment process, where residues are separated. After the pH-adjustment process, the magnesium-rich solution reacts with ammonium bicarbonate (NH₄HCO₃) to produce carbonates in the aqueous carbonation step. Ammonium bicarbonate (NH₄HCO₃) comes from the CO₂ supply stage, where CO₂ is captured using ammonia (NH₃) and water. After the aqueous carbonation step, the produced carbonates are dewatered in the post-processing stage. Solids are transferred to the use stage. The recovered solution is recycled to the reagent recovery process, where ammonium bisulfate (NH₄HSO₄) is regenerated and recycled to the different processes. The regeneration process is modelled following Sanna *et al.*^{60,61} However, to integrate the heat of the regeneration process, vapor recompression is employed here for the steam produced from regeneration step such that it can be reused to recover ammonium bisulfate. Thus, the resulting electricity demand is higher than in Sanna *et al.*^{60,61} while the thermal energy demand of the carbonation stage is much lower.

In the use stage, products are mixed (if required) and substitute ordinary Portland cement.

The pH of the solution in the Nottingham pathway changes from the aqueous extraction process to the carbonation process.

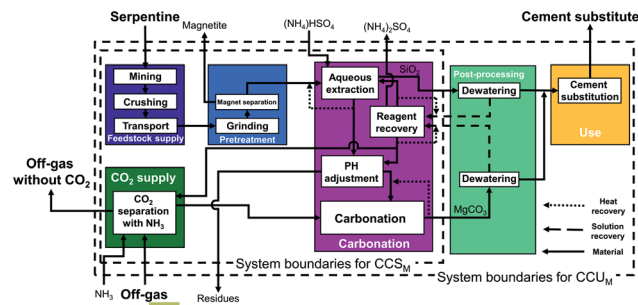

Fig. 7 Process flow diagram of carbon capture and utilization by mineralization via indirect concept of the Nottingham pathway (pH swing) using serpentine. CCS_M is carbon capture and storage by mineralization. CCU_M is carbon capture and utilization by mineralization.



Due to this fact, the Nottingham pathway is also known as “pH-swing pathway”.

The Nottingham pathway has three advantages: the production of separated and very pure products at each step, the moderate conditions of the reactor (temperature, pressure), and the ability to directly employ off-gas (15–20% CO₂) instead of pure CO₂. These features allow to avoid energy-intensive processes and lower the energy demand of the pathway. For our study, we consider the pathway based on Wang & Maroto-Valer *et al.*^{14,19}

3.2. Background data and scenarios

In this section, we specify the data for the calculation of the life-cycle inventories. We divide our data into 3 groups: background data, the state-of-the-art scenario, and the ideal-mineralization scenario.

Background data. For the energy supply, we use the current European grid mix, and the required thermal energy is provided directly from natural gas combustion. The LCA data sets for energy supply are based on the LCA database GaBi (see the ESI, Section S6†).⁶² The construction of the CO₂ mineralization factory is modeled by a generic dataset for construction of a metal industry factory from the LCA database ecoinvent,⁶³ which is based on a production capacity of 100 000 ton per year and plant lifetime of 50 years (see the ESI, Section S5†).

For the feedstock supply stage, we consider open-pit mines for olivine and serpentine.²³ Based on a study for the economic feasibility of bulk minerals, the mines are assumed to be within 260 km radius of the mineralization plant, and the method of transport is a truck for the first 60 km and a train for the next 200 km.^{48,64} Feedstock composition is taken from literature: olivine is 80 wt% forsterite and 20 wt% ferrian;^{65–67} serpentine is 90 wt% lizardit and 10 wt% magnetite,¹⁹ and steel slag is 60 wt% calcium silicate.⁶⁸ We assume steel slag of Basic Oxygen Furnace (BOF) as a waste stream of the steel industry. Hence, the carbon footprint of incoming steel slag is zero CO_{2e}.^{40,69}

For the feedstock pretreatment stage, we calculate the electricity demand of crushing and grinding (down to 75 μm) *via* Bond's equation.⁷⁰ The electricity demand of milling (finer than 75 μm) is based on literature data.¹³ The thermal energy demand of heat pretreatment is based on literature data, and we assume the recovery of 80% of the sensible heat from the feedstock after the heat pretreatment.^{13,15} Based on literature,⁷¹ we assume that magnetite can be magnetically separated from serpentine and the recovered magnetite can substitute iron ore. Iron ore substitution avoids the environmental impacts of the conventional production of iron ore (data taken from literature⁷² and LCA database, see the ESI, Section S5†).^{62,63}

For CO₂ supply, we consider a steel plant as the CO₂ point source. If the pathway requires pure CO₂, the CO₂ is captured from the off-gas. The energy demand of the CO₂ capture is based on literature data.^{73–76} The electricity demand of CO₂ compression is calculated individually for each pathway through process simulation. We consider a multi-stage compressor with a polytropic efficiency of 80%, a compression ratio of maximum 2 and an intercooler after each stage, in

ASPEN Plus.⁷⁷ If the pathway applies directly the off-gas as CO₂ source, only the compression of the off-gas is considered.

In the carbonation stage, we consider a heat recovery system based on pinch analysis. We assume no credit for excess thermal energy. The life cycle inventory of additives and chemicals are based on a LCA database (see the ESI, Section S5†).^{62,63,78}

For post-processing, separation of both the aqueous solution and the mineralization products are calculated based on literature data with an energy demand of ~8 kWh per ton.^{13,18} The electricity demands of dewatering, classification, and gravity separation are also based on literature data.¹⁸ We assume that the mineralization plant is located at a cement plant, thus distance of product transport is zero.

For the use stage, we calculate the substitution of ordinary Portland cement *via* mineralization products based on performance (Section 2.2).⁴⁵ The carbon footprint of conventional ordinary Portland cement is 819 kg CO_{2e} per ton.⁷⁹

State-of-the-art scenario. To illustrate the status of current research, we define the state-of-the-art scenario based on accomplished data. In particular, we employ the highest reaction yields reported in the literature. The accomplished reaction yield is based on laboratory analysis (see the ESI, Section S7†).^{13,14,53,57,59,80} We assume heat recovery based on pinch analysis and a minimum temperature difference of 10 °C.⁷⁰ 90% of the solution is assumed to be recovered based on reported losses of additives that is around 10% in solid/solution separation (90% solution recovery).^{13,18} Further, we consider conventional CO₂ capture using monoethanolamine (MEA) as solvent.⁷³ MEA technology is one of the most developed technology in CO₂ capture and can thus certainly be considered as state-of-the-art.^{73,81}

Most importantly, we consider only the substitution of cement by silicon dioxide (SiO₂). According to a recent study, silicon dioxide (SiO₂) can have pozzolanic properties and can thus substitute ordinary Portland cement with a 5% decrease in performance.⁴⁵ The other products of mineralization, magnesium carbonate or calcium carbonate (MgCO₃ or CaCO₃), are assumed to have no pozzolanic or cementitious properties. Thus, no substitution credit is given. However, we study the substitution credit in the sensitivity analysis (Section 4.4).

Ideal-mineralization scenario. To compute an upper bound for the potential of CCU by mineralization, we define an ideal-mineralization scenario, where all process inefficiencies are neglected, and all products are utilized completely to substitute cement. Thus, we assume 100% reaction yield for all reactions as well as an almost complete process heat integration based on pinch analysis with a minimum temperature difference of 5 °C.⁷⁰ Likewise, the complete amount of solution is recovered without any losses of additives or water (100% solution recovery). A CO₂ capture technology with a novel solvent (2-amino-2-methyl-1-propanol, AMP), which has a lower energy consumption than MEA solvent, is assumed (low emission CO₂ capture).⁷⁵ Most importantly, all mineralization products (silicon dioxide plus magnesium carbonate or calcium carbonate, SiO₂ + MgCO₃ or CaCO₃) are assumed to substitute ordinary Portland cement 1 : 1 on mass basis (100% substitution).



4. Carbon footprint of CCU by mineralization

To illustrate our LCA method, we first present the carbon footprint for the aqueous mineralization in CSTR at 115 bar using serpentine in detail. In Sections 4.2 and 4.3, we show the carbon footprints for all 7 CCU by mineralization pathways in a more condensed form.

4.1. Carbon footprint of CSTR 115 bar pathway using serpentine

By applying the presented LCA method for CCU by mineralization (Section 2), we calculate the carbon footprint of the CSTR 115 bar pathway for the state-of-the-art scenario (Fig. 8).

The total carbon footprint by mineralization and utilization of 1 ton CO₂ is negative with a value of -1.15 ton of CO_{2e}. The negative carbon footprint means that the CCU system (Fig. 2a) has less emissions than the reference system (Fig. 2b) since the CCU system avoids more CO_{2e} emissions than it produces. CCU by mineralization avoids CO_{2e} emissions by two mechanisms: (1) by removing and converting CO₂ from the off-gas and (2) by substituting cement. The CO₂ reacted by mineralization is permanently stored in stable magnesium carbonate (MgCO₃). Furthermore, without the mineralization plant, the CO₂ in the off-gas would be emitted from the steel plant into the atmosphere (*cf.* Section 2.1). Thus, the 1 ton of CO₂ stored from off-gas reduces the carbon footprint by 1 ton CO_{2e}. The uptake from CO₂ is the largest contribution to the carbon footprint. The second largest contribution to the reduction in the carbon footprint is the product substitution with a value of -0.71 ton CO_{2e} per ton CO₂ stored.

All other life cycle stages increase the carbon footprint of CCU by mineralization. The largest contribution is due to the

CO₂ supply stage, which adds $+0.20$ ton CO_{2e} per ton CO₂ stored, as CO₂ capture and compression is an energy-intensive process. The next large positive contributions to the carbon footprint come from the carbonation stage and the pretreatment with $+0.13$ ton CO_{2e} per ton CO₂ stored and $+0.15$ ton CO_{2e} per ton CO₂ stored, respectively. The carbonation stage emits CO_{2e} despite being exergonic as a result of the carbon footprint of additives, heat losses, pumping, *etc.*, which offset the effect of exergonic reaction. The carbon footprint of the pretreatment stage is due to the high energy demand of grinding and heat pretreatment. Smaller contributions to the carbon footprint of CCU by mineralization are due to post-processing ($+0.02$ ton CO_{2e} per ton CO₂ stored), feedstock supply ($+0.03$ ton CO_{2e} per ton CO₂ stored) and factory construction ($+0.03$ ton CO_{2e} per ton CO₂ stored). We present the life cycle inventory data in more detail in the ESI, Sections S8 and S9.†

To contextualize the carbon footprint of CCU by mineralization pathways, we define a break-even target and the CCS limit (Fig. 8). Break-even is achieved when the avoided CO_{2e} emissions equal to CO_{2e} emissions caused throughout the life-cycle such that the total carbon footprint is zero. Thus, a negative carbon footprint shows that the CCU pathway (Fig. 2a) has lower GHG emissions than the reference system (Fig. 2a). However, a negative carbon footprint does not mean that CCU by mineralization is carbon negative from cradle-to-grave.⁸²

The CCS limit illustrates the maximum potential of carbon capture and storage (CCS) technologies without utilization. A CCS technology reaches its maximum potential for reductions of CO_{2e} emissions if the CCS process does not cause any direct or indirect CO_{2e} emissions while capturing and storing 1 ton CO₂. The carbon footprint of such an ideal CCS process would be -1 ton CO_{2e}. The carbon footprint of a CCU technologies can be theoretically better than the CCS limit. This advantage is due to the substitution credit in the “use stage”. With the

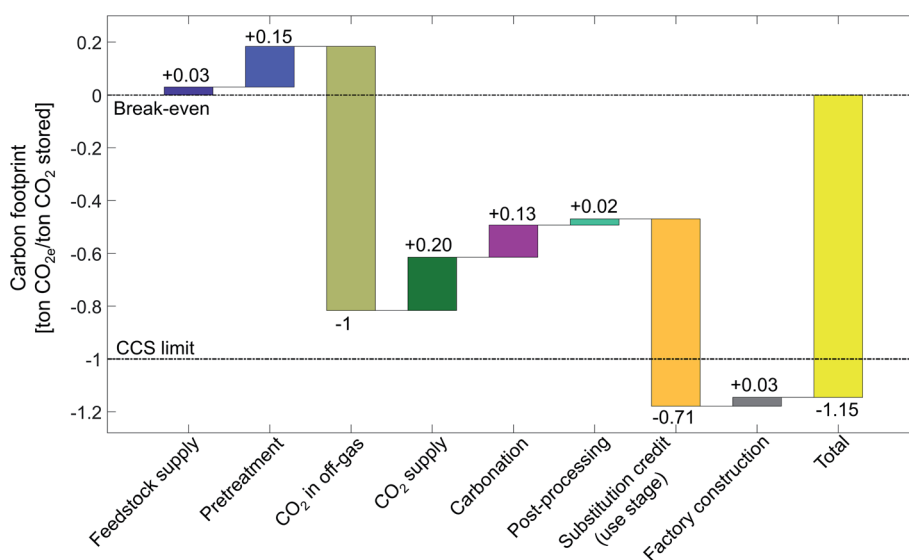

Fig. 8 Carbon footprint of CSTR 115 bar using serpentine for state-of-the-art scenario. Carbon footprint contribution of each life cycle stage is shown as separate bar. Break-even is where the avoided CO_{2e} emissions is equal to CO_{2e} emissions caused throughout the life-cycle such that the total carbon footprint is zero. CCS limit is the maximum potential of CCS technologies.



substitution credit, CCU by mineralization can avoid more than 1 ton CO_{2e} per ton CO₂ captured.

4.2. Carbon footprint of CCU by mineralization pathways for the state-of-the-art scenario

The state-of-the-art scenario illustrates the status of current research and is based on accomplished rates in laboratory for all considered CCU pathways (Fig. 9).

CCU by mineralization avoids up to 1.17 ton CO_{2e} per ton CO₂ stored, which is the carbon footprint of the indirect Abo Academy pathway using serpentine. Overall, 5 pathways (CSTR 115 bar, CSTR 10 bar, CSTR 100 bar, rotary packed bed and Abo Academy pathway) avoid more emissions than just storing CO₂.

All pathways avoid CO_{2e} emissions by storing CO₂ and by substituting cement. Since the stored CO₂ is the functional unit of our study, all pathways reduce CO_{2e} by 1 ton CO_{2e} by CO₂ from the off-gas. The credit for substituting cements ranges from 0.53 to 1.3 ton CO_{2e} per ton CO₂ stored. The variation in the substitution credits is due to variation of the product mass, which are in turn caused by the diverse feedstock and reaction routes of the pathways. The substitution credit of the indirect pathways is always higher than for the direct pathways. The reason is our functional unit of 1 ton CO₂ stored which means that 1 ton of CO₂ is reacted in the carbonation process. In indirect pathways, silicon dioxide (SiO₂) is produced in the first carbonation step and CO₂ is reacted in the second carbonation step. Silicon dioxide (SiO₂) can substitute cement, thus more SiO₂ increases

the substitution credit. Due to the lower reaction yield of the second carbonation step, indirect pathways require more product from the first carbonation step, which increases the production of silicon dioxide (SiO₂) thus the substitution credit.

Except for the substitution credit and storing CO₂, all other life cycle stages increase the carbon footprint of the CCU by mineralization. For most pathways, the largest contribution to the carbon footprint is due to the carbonation stage, which vary from +72 to +1175 kg CO_{2e} per ton CO₂ stored. This variation shows the strong dependence of the carbon footprint on the employed carbonation process. Carbonation for CSTR 100 bar has a small contribution to the carbon footprint due to the exergonic nature of the reaction. In contrast, in the indirect pathways, the carbonation stage has a much higher contribution to the carbon footprint (e.g., +72 kg CO_{2e} per ton CO₂ stored for the direct CSTR100 pathway vs. 1175 kg CO_{2e} per ton CO₂ stored for the indirect Nottingham pathway). This difference can be traced back to energy-intensive processes, such as reagent recovery, that are specific to the indirect pathways. To avoid the reagent recovery but benefit from benefits of the indirect pathways, Park and Fan⁸³ introduced a mineralization concept with CO₂ as an extraction agent.

The second largest positive contribution to the carbon footprint is often the CO₂ supply stage, which also varies substantially between the pathways. The pathways that require pure CO₂ (CSTR 115 bar, CSTR 150 bar, CSTR 100 bar, and Abo Academy pathway) have higher CO_{2e} emissions (range from 130 to 237 kg CO_{2e} per ton CO₂ stored) in the CO₂ supply stage than pathways operating directly with off-gas (rotary packed bed,

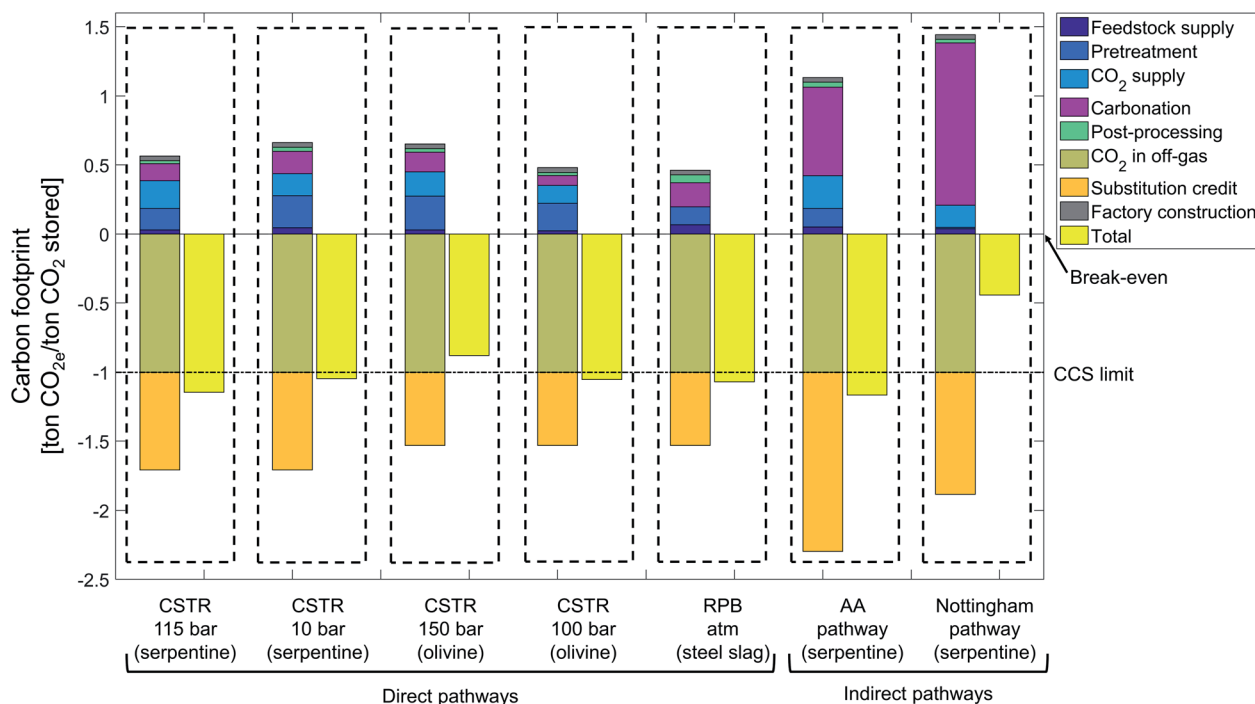

Fig. 9 Carbon footprint of the 7 CCU by mineralization pathways for state-of-the-art scenario. For each pathway, the left bar shows the contribution of each life cycle stage and the right bar shows the total carbon footprint of the pathway. Break-even is where the avoided CO_{2e} emissions is equal to CO_{2e} emissions caused throughout the life-cycle such that the total carbon footprint is zero. CCS limit is the maximum potential of CCS technologies. RPB – rotary packed bed, AA – Abo Academy.



CSTR 10 bar and Nottingham range from 0.1 to 160 kg CO_{2e} per ton CO₂ stored). Note that for the pathways that require pure CO₂ (CSTR 115 bar, CSTR 150 bar, CSTR 100, bar and Abo Academy pathway), the excess heat generated in the carbonation stage is integrated into the CO₂ supply stage and reduces the need for external energy supply. We present the life cycle inventory data of the considered CCU by mineralization pathways in the ESI, Sections S8 and S9.†

In literature, the pretreatment stage is one of the most discussed subjects in mineralization.⁸⁴ Indeed, the carbon footprint of the pretreatment stage varies strongly depending on:

- The particle size: decreasing the particle size from 75 μm to 10 μm adds 91 kg CO_{2e} per ton feedstock to the carbon footprint (Nottingham pathway vs. CSTR 100 bar).
- The necessity of heat pretreatment, which adds 31 kg CO_{2e} per ton feedstock to the carbon footprint (Nottingham vs. Abo Academy pathway).

In general, direct pathways require a more intensive pretreatment than indirect pathways because the indirect pathways benefit from chemical leaching, which accelerates carbonation. The pathways that require a heat pretreatment or a finer particle size have a higher carbon footprint for pretreatment. Heat pretreatment is an energy-intensive process and could offset the benefits of CCU by mineralization. Thus, some researchers have proposed to disregard pathways that required heat pretreatment.⁸⁵ To assess this proposition, we can compare the carbon footprint of the pretreatment stage for the pathways CSTR 115 bar and CSTR 150 bar. In the CSTR 115 bar pathway using serpentine, heat pretreatment is applied to the feedstock, and the carbon footprint of the pretreatment stage is 153 kg CO_{2e} per ton CO₂ stored. On the other hand, the CSTR 150 bar pathway using olivine requires extra grinding and milling for feedstock

pretreatment, which cause 243 kg CO_{2e} per ton CO₂ stored. Thus, the carbon footprint without heat pretreatment is 90 kg CO_{2e} per ton CO₂ stored higher. This analysis shows that heat pretreatment cannot be excluded in general for CCU by mineralization pathways.

The post-processing, factory construction and feedstock supply stage cause relatively few CO_{2e} emissions in all pathways, ranging from 22 to 67 kg CO_{2e} per ton CO₂ stored, respectively.

4.3. Carbon footprint of CCU by mineralization pathways for the ideal-mineralization scenario

The ideal-mineralization scenario neglects all process inefficiencies and utilizes the entire product, so that an upper bound on the potential of CCU by mineralization can be determined (Fig. 10).

For the ideal-mineralization scenario, the carbon footprint due to mineralization of 1 ton CO₂ ranges from −2.6 to −3.2 ton CO_{2e}. The carbon footprint reduction is thus much higher than in the state-of-the-art scenario. This increase is due to the increased amounts of CO_{2e} avoided by substitution and the decreased carbon footprint of all processing stages.

From the two mechanisms to avoid CO_{2e} emissions, the amount of stored CO₂ is by definition the same as in the state-of-the-art scenario, but the substitution credit increases substantially to −2.1 to −2.7 ton CO_{2e} per ton CO₂ stored. The substitution credit increases since we assume that all products can be employed as cement substitutes: not only silicon dioxide, but also magnesium or calcium carbonate (SiO₂ + MgCO₃ or CaCO₃). In this way, the substitution credit increases. However, it should be pointed out that this assumption would require a massive development in product properties. This analysis shows that this development would be highly desirable.

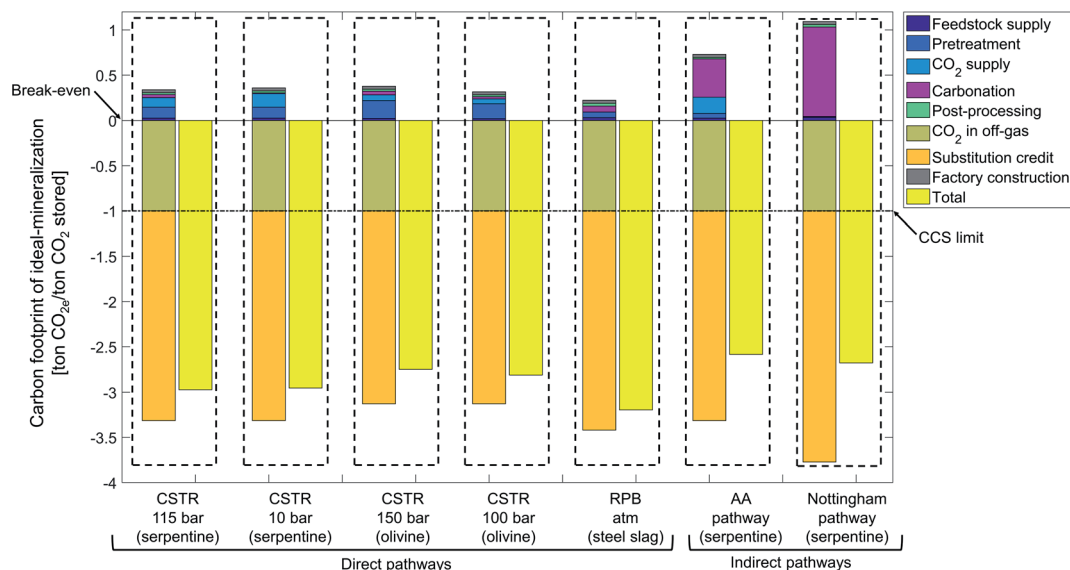

Fig. 10 Carbon footprint of the 7 CCU by mineralization pathways for the ideal-mineralization scenario. For each pathway, the left bar shows the contribution of each life cycle stage, and the right bar shows the total carbon footprint. Break-even is where the avoided CO_{2e} emissions are equal to CO_{2e} emissions caused throughout the life-cycle such that the total carbon footprint is zero. CCS limit is the maximum potential of CCS technologies. RPB – rotary packed bed, AA – Abo Academy.



Fig. 10 shows also a massive reduction of CO_{2e} emissions for all other stages. This reduction is due to the higher reaction yield, higher heat recovery, and higher solution recovery as well as the high efficiency CO₂ capture technology, which all reduce the energy or material demand, and consequently decrease carbon footprint.

Overall, the upper bound on the CO_{2e} emissions avoided by CCU by mineralization is 2.6 to 3.2 times higher than just storing CO₂. Even though the ideal-mineralization scenario will not be achievable in practice, the calculation shows the large potential of CCU by mineralization and the significant opportunities to improve the process itself and the product properties.

4.4. Sensitivity analysis for the state-of-the-art scenario

The preceding analysis fixed the feedstock, the carbon footprint of the electricity supply, and the location of the mineralization plant. To investigate the impact of these parameters, we perform a sensitivity analysis. The results also show the important role of the substitution credit for the carbon footprint. Thus, we also perform a sensitivity analysis on the substitution credit.

Feedstock purity. Most of the mineralization feedstock are not 100% pure, and the purity can vary strongly depending on the feedstock source.⁶⁷ The purity of the feedstock has a strong effect on the carbon footprint of CCU by mineralization (Fig. 11).

Low feedstock purity increases the amounts of solid handling and treatment, which consequently increases the energy demand and thus the carbon footprint of CCU by mineralization pathways. For all pathways, the carbon footprint is inversely proportional to feedstock purity. The carbon footprint of the CCU by mineralization pathways increases moderately from 100% until approximately 50% feedstock purity, however, the carbon footprint increases rapidly for feedstock

purities lower than 50%. The dependence on feedstock purity is mainly determined by the energy demand of the pathway. As a result, the Nottingham pathway shows a stronger dependence on feedstock purity than the other pathways and crosses the break-even line at the feedstock purity of approximately 68%. For a feedstock purity lower than 20%, just the Abo Academy and the rotary packed bed pathways still reduce GHG emissions as indicated by the negative carbon footprint.

The sensitivity analysis on the *carbon footprint of the electricity supply* (see the ESI, Section S3†) shows that decreasing the carbon footprint of electricity supply decreases the carbon footprint of all mineralization pathways. The minimum carbon footprint is reached for an electricity supply with zero emissions and ranges from -1.41 ton CO_{2e} per ton CO₂ stored for the CSTR 150 bar pathway to -2.20 ton CO_{2e} per ton CO₂ stored for the Abo Academy pathway. The order of the pathways stays practically the same with the exception of the Nottingham pathway which has the largest carbon footprint in the state-of-the-art scenario and the second smallest for zero-carbon electricity due to its higher energy demand. Still, for all mineralization pathways, the dependence on electricity supply is much smaller than observed for other CCU pathways depending on water electrolysis for hydrogen production.⁸⁶

For the *feedstock transport distance* (see the ESI, Section S4†), the effect on the carbon footprint is moderate for all pathways for CCU by mineralization. Doubling the transport distance to 520 km increases the carbon footprint at most by 60 kg CO_{2e} per ton CO₂ stored for the rotary packed bed pathway. Beyond 1000 km transport distance, the effect of feedstock transport distance on the carbon footprint becomes negligible since long distance transports typically employs efficient cargo ships.

Substitution credit. As the results showed (Sections 4.2 and 4.3), substitution credit is a major contribution to the carbon footprint of CCU by mineralization. The substitution credit itself depends strongly on product performance. In most previous studies,^{39,40} it has been assumed that the substitution credit is equal to the environmental impacts of conventional production of the substituted product (1 : 1 credit). However, the performance of new products can differ from the conventional product. Therefore, the 1 : 1 substitution can be misleading. Here, we employed a substitution factor of 95% based on experimental findings on performance of blended cement.⁴⁵

To determine the substitution credit for mineralization products in general, we present a workflow (Fig. 12): The central question is how the new product performs in comparison to the conventional product. The performance can be the same, better or worse. If the performance is the same, the substitution credit is indeed equal to the environmental impact of the conventional product (1 : 1 credit). If the performance is better, the substitution credit is still 1 : 1 if the higher performance of the new product is not beneficial for its function. In contrast, if the higher performance of the new product is beneficial for its function (*e.g.*, less mass required for the same material strength), the substitution credit should measure this increase in performance (percentage credit, *e.g.*, for reduced reference flow to achieve the same function). If the performance is worse,

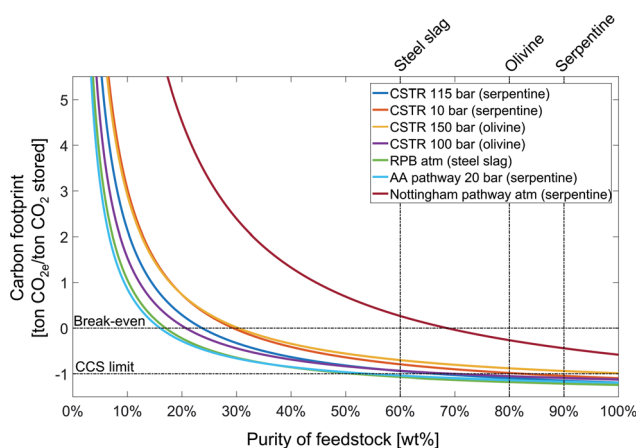

Fig. 11 Carbon footprint of the 7 CCU by mineralization pathways as function of feedstock purity for the state-of-the-art scenario. Break-even is where the avoided CO_{2e} emissions are equal to CO_{2e} emissions caused throughout the life-cycle such that the total carbon footprint is zero. CCS limit is the maximum potential of CCS technologies. The feedstock purity assumed in the state-of-the-art scenario is also marked with 60% for steel slag, 90% for serpentine, and 80% for olivine. RPB – rotary packed bed, AA – Abo Academy.



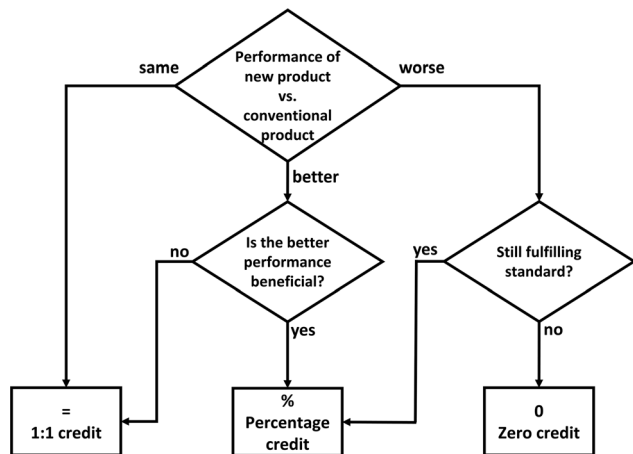

Fig. 12 Guideline to calculate the substitution credit for products of CCU by mineralization. 1 : 1 credit means that the substitution credit is equal to environmental impact of the conventional product. Percentage credit means that the substitution credit is a percentage of environmental impacts of the conventional product. Zero credit means that there is no substitution effect and thus no substitution credit.

we need to check if the new product still fulfills the required standards for the function, in particular for building materials: if yes, the performance loss should be accounted by the percentage credit; if not, the substitution credit is zero because the CCU product does not fulfill the function.

Fig. 13 shows the sensitivity analysis of the carbon footprint of the studied CCU by mineralization pathways on the substitution credit for the state-of-the-art scenario. Here, we define a product substitution percentage: the product substitution percentage is the mass of substituted product divided by the maximum possible product mass, which is the amount of silicon dioxide plus carbonate, *i.e.*, $\text{SiO}_2 + \text{MgCO}_3$ or CaCO_3 .

For all pathways for CCU by mineralization, increasing the product substitution percentage increases the amount of products available for substitution and consequently the substitution credit. *E.g.*, for the rotary packed bed pathway, the carbon footprint decreases from approximately -0.5 to -3 ton CO_{2e} per ton CO_2 stored from 0% to 100% product substitution percentage. All 7 pathways reduce the carbon footprint more than the maximum potential of CCS technology, if the product substitution percentage reaches 53%.

As the pathways for CCU by mineralization produce different amount of products, the slope of the lines and also switching to substitution by carbonates are different. For all pathways, the amount of MgCO_3 or CaCO_3 produced is higher than SiO_2 . Thus, if substitution by MgCO_3 or CaCO_3 would be possible, the carbon footprint of CCU by mineralization pathways could be even more strongly reduced. *E.g.*, for the CSTR 100 bar pathway, the total carbon footprint reduces from -1.08 ton CO_{2e} per ton CO_2 stored at 26% product substitution percentage, corresponding to the total amount of SiO_2 , to -2.65 ton CO_{2e} per ton CO_2 stored for 100% product substitution percentage, where all SiO_2 and MgCO_3 are utilized.

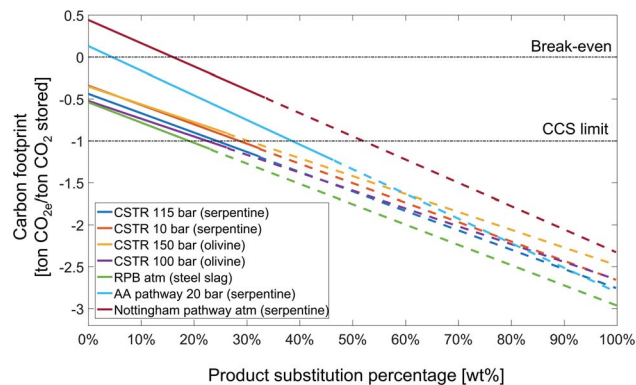

Fig. 13 Carbon footprint of the 7 CCU by mineralization pathways as function of product substitution percentage (the mass of substituted product divided by the maximum possible mass of products ($\text{SiO}_2 + \text{MgCO}_3/\text{CaCO}_3$)) for state-of-the-art scenario. Solid lines represent the substitution by SiO_2 only. Dashed lines show the additional substitution by MgCO_3 or CaCO_3 . Break-even is where the avoided CO_{2e} emissions are equal to CO_{2e} emissions caused throughout the life-cycle such that the total carbon footprint is zero. The CCS limit is the maximum potential of CCS technologies. RPB – rotary packed bed, AA – Abo Academy.

The Nottingham and Abo Academy pathways cross the break-even line of zero carbon footprint at 16% and 5% product substitution percentage, respectively. For the state-of-the-art scenario, the Nottingham and Abo Academy pathway has positive carbon footprint without the substitution credit; hence, the Nottingham and Abo Academy pathways are currently not suitable for CCS by mineralization, and the substitution credit is here critical to achieve an overall negative carbon footprint.

To conclude, the carbon footprint of CCU by mineralization pathways is extremely sensitive to the substitution credit, and a sound analysis of the substitution credit is essential.

Alternative substitution materials for ordinary portland cement. In our study, we consider that the products of mineralization can be mixed with ordinary Portland cement (OPC) and produce blended cement. Thereby, ordinary Portland cement is partially substituted on a performance basis. To understand the impact of substitution, we present a sensitivity analysis on substitution credit above. However, beyond performance and the amount of the mineralization products, market size and alternative cement substitutes can also affect the substitution credit.^{46,50} In particular, products from CCU by mineralization are not the only potential cement substitutes. Thus, we have to analyze whether CCU products would in fact replace cement or only alternative cement substitutes.

To investigate the effect of market size and alternative cement substitutes, we analyze the cement market (Fig. 14) and conventional cement substitutes, *e.g.*, steel slag, coal fly ash, ground glass, silica fume, and natural Pozzolan.⁵⁰ The global market of ordinary Portland cement is estimated to be 4.5 Gt per year.⁸⁷ According to the standard for blended cement (ASTM C595), a maximum 40% of the global ordinary Portland cement market is available for substitution (approx. 1.8 Gt per year).^{88,89} The global production market of steel slag and coal fly ash are



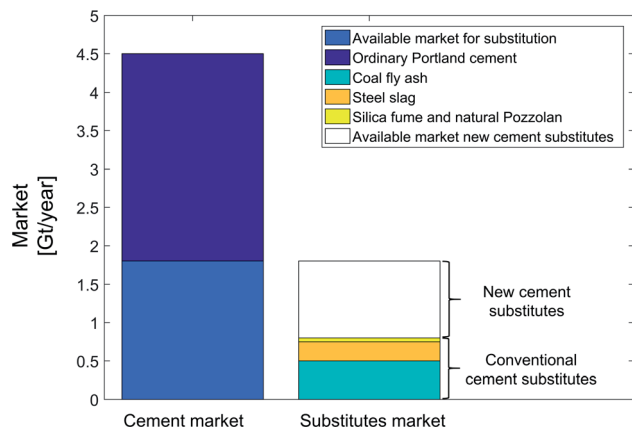

Fig. 14 Global cement market and the global available market for substitution.

around 0.25 Gt per year and 0.5 Gt per year, respectively.⁵⁰ Note that coal power plants are expected to shut down in future such that the amount of coal fly ash should be expected to reduce.⁷ The sum of the current global production markets for all conventional cement substitutes is about 0.8 Gt per year. As a result, there is still an available market of 1 Gt per year for new cement substitutes, which can be filled with mineralization products. To conclude, conventional cement substitutes have no effect on the substitution credit of CCU by mineralization pathways, as the available market is much larger than production market of the conventional cement substitutes.

5. Conclusions

Carbon capture and utilization by CO₂ mineralization is a promising technology to reduce greenhouse gas emissions by storing CO₂ and by substituting conventional products. However, energy demand for mineralization is high to overcome the slow reaction kinetics. Our assessment of the carbon footprint of carbon capture and utilization by mineralization shows that the studied 7 pathways proposed in literature could all reduce GHG emissions if the produced SiO₂ substitutes cement.

The largest reductions in GHG emissions stems from the conversion and permanent storage of CO₂. The second largest reduction is due to product substitution. *Via* substitution of conventional production, capturing and mineralizing 1 ton CO₂ could avoid more than 1 ton of CO_{2e} emissions. However, the carbon footprint of CCU by mineralization pathways is extremely sensitive to the substitution credit and thus, a sound analysis of the substitution credit is essential. The development of markets for products from CO₂ mineralization seems desirable.

All other life cycle stages increase the carbon footprint of CCU by mineralization. For indirect pathways, the largest contribution is due to the carbonation stage, as reagent recovery is an energy-intensive process. For direct pathways, if the pathway employs pure CO₂, the largest contribution is due to the CO₂ supply stage, otherwise due to pretreatment stage. The

findings emphasize the need to further improve performance of CO₂ mineralization processes.

Current data suggests that up to 1 Gt per year of the cement market could be substituted by mineralization products. Based on the present analysis, the resulting reduction of the carbon footprint would range from 0.4 Gt CO_{2e} per year to 1.5 Gt CO_{2e} per year; corresponding up to 3% of the global GHG emissions.¹ While further environmental impacts should still be assessed, the present analysis suggests that future research should explore novel pathways and possible applications for products from CO₂ mineralization.

Conflicts of interest

There are no conflicts to declare.

Acknowledgements

This work has been carried out within the project “CO2MIN” (033RC014). The project is funded by the German Federal Ministry of Education and Research (BMBF). For the continuous support and cooperation, we would like to thank our project partners from RWTH Aachen, IASS Potsdam, and HeidelbergCement AG.

References

- 1 IPCC, Contribution of Working Group III to the Fifth Assessment Report of the Intergovernmental Panel on Climate Change, *Climate Change 2014: Mitigation of Climate Change*, ed. O. Edenhofer, R. Pichs-Madruga, Y. Sokona, E. Farahani and S. Kadner, 2014.
- 2 IPCC, Summary for Policymakers, in *Global warming of 1.5 °C. An IPCC Special Report on the impacts of global warming of 1.5 °C above pre-industrial levels and related global greenhouse gas emission pathways, in the context of strengthening the global response to the threat of climate change, sustainable development, and efforts to eradicate poverty*, 2018.
- 3 IEA, *Technology Roadmap Low-Carbon Transition in the Cement Industry*, 2018.
- 4 Umweltbundesamt, *Treibhausgas Emissionen seit 1990 nach Gasen*, 2018.
- 5 W. Shen, L. Cao, Q. Li, W. Zhang, G. Wang and C. Li, *Renew. Sustain. Energy Rev.*, 2015, **50**, 1004.
- 6 C. T. Michael Taylor and D. Gielen, *Energy Efficiency and CO₂ Emissions from the Global Cement Industry*, IEA-WBCSD workshop, 2006.
- 7 IEA, *Energy Climate and Change-World Energy Outlook Special Report*, 2015.
- 8 M. Bui, C. S. Adjiman, A. Bardow, E. J. Anthony, A. Boston, S. Brown, P. S. Fennell, S. Fuss, A. Galindo, L. A. Hackett, J. P. Hallett, H. J. Herzog, G. Jackson, J. Kemper, S. Krevor, G. C. Maitland, M. Matuszewski, I. S. Metcalfe, C. Petit, G. Puxty, J. Reimer, D. M. Reiner, E. S. Rubin, S. A. Scott, N. Shah, B. Smit, J. P. M. Trusler, P. Webley, J. Wilcox and N. Mac Dowell, *Energy Environ. Sci.*, 2018, **11**(5), 1062.



- 9 V. Romanov, Y. Soong, C. Carney, G. E. Rush, B. Nielsen and W. O'Connor, *ChemBioEng Rev.*, 2015, **2**(4), 231.
- 10 A. Zapantis, *Policy Priorities To Incentivise Large Scale Deployment Of Ccs*, 2019.
- 11 H. J. Herzog, *Energy Econ.*, 2011, **33**(4), 597.
- 12 M. Mazzotti, *IPCC Special Report on Carbon dioxide Capture and Storage*, 2005.
- 13 W. O'Connor, D. C. Dahlin, G. E. Rush, S. J. Gerdemann, L. R. Penner and D. N. Nilsen, *Aqueous Mineral Carbonation: Mineral Availability, Pretreatment, Reaction Parametrics, and Process Studies*, 2005.
- 14 X. Wang and M. M. Maroto-Valer, *ChemSusChem*, 2011, **4**(9), 1291.
- 15 R. D. Balucan, B. Z. Dlugogorski, E. M. Kennedy, I. V. Belova and G. E. Murch, *Int. J. Greenhouse Gas Control*, 2013, **17**, 225.
- 16 J. Li and M. Hitch, *Miner. Eng.*, 2018, **128**, 69.
- 17 M. Ghoorah, B. Z. Dlugogorski, R. D. Balucan and E. M. Kennedy, *Fuel*, 2014, **122**, 277.
- 18 A. Sanna, R. H. Matthew and M.-V. Mercedes, *Energy Environ. Sci.*, 2012, **5**, 7781.
- 19 X. Wang and M. M. Maroto-Valer, *Fuel*, 2011, **90**(3), 1229.
- 20 P. K. Naraharisetti, T. Y. Yeo and J. Bu, *ChemPhysChem*, 2017, **18**(22), 3189.
- 21 G. Costa, A. Poletini, R. Pomi, A. Stramazzo and D. Zingaretti, *Greenhouse Gases: Sci. Technol.*, 2017, **7**(3), 530.
- 22 N. Kemache, L.-C. Pasquier, E. Cecchi, I. Mouedhen, J.-F. Blais and G. Mercier, *Fuel Process. Technol.*, 2017, **166**, 209.
- 23 S. J. T. Hangx and C. J. Spiers, *Int. J. Greenhouse Gas Control*, 2009, **3**(6), 757.
- 24 A. Sanna, M. Uibu, G. Caramanna, R. Kuusik and M. M. Maroto-Valer, *Chem. Soc. Rev.*, 2014, **43**(23), 8049.
- 25 G. F. Brent, D. J. Allen, B. R. Eichler, J. G. Petrie, J. P. Mann and B. S. Haynes, *J. Ind. Ecol.*, 2012, **16**(1), 94.
- 26 D. Zingaretti, G. Costa and R. Baciocchi, *Ind. Eng. Chem. Res.*, 2013, **53**(22), 9311.
- 27 W. J. J. Huijgen, G. J. Ruijg, R. N. J. Comans and G.-J. Witkamp, *Ind. Eng. Chem. Res.*, 2006, **45**(26), 9184.
- 28 ILCD Handbook, *International Reference Life Cycle Data System (ILCD) Handbook - General guide for Life Cycle Assessment*, European Commission - Joint Research Centre - Institute for Environment and Sustainability, 2010.
- 29 S. Giannoulakis, V. Kathrin and B. Christian, *Int. J. Greenhouse Gas Control*, 2014, **21**, 140.
- 30 L.-S. Xiao, R. Wang, P.-C. Chiang, S.-Y. Pan, Q.-H. Guo and E. E. Chang, *Aerosol Air Qual. Res.*, 2014, **14**(3), 892.
- 31 C. Julcour, F. Bourgeois, B. Bonfils, I. Benhamed, F. Guyot, F. Bodéan, C. Petiot and É. C. Gaucher, *Chem. Eng. J.*, 2015, **262**, 716.
- 32 M. S. Ncongwane, J. L. Broadhurst and J. Petersen, *Int. J. Greenhouse Gas Control*, 2018, **77**, 70.
- 33 H. H. Khoo, J. Bu, R. L. Wong, S. Y. Kuan and P. N. Sharratt, *Energy Procedia*, 2011, **4**, 2494.
- 34 H. H. Khoo, P. N. Sharratt, J. Bu, T. Y. Yeo, A. Borgna, J. G. Highfield, T. G. Björklöf and R. Zevenhoven, *Ind. Eng. Chem. Res.*, 2011, **50**(19), 11350.
- 35 E. Nduagu, J. Bergerson and R. Zevenhoven, *Energy Convers. Manage.*, 2012, **55**, 116.
- 36 R. M. Cuéllar-Franca and A. Azapagic, *J. CO₂ Util.*, 2015, **9**, 82.
- 37 K. E. Kelly, G. D. Silcox, A. F. Sarofim and D. W. Pershing, *Int. J. Greenhouse Gas Control*, 2011, **5**(6), 1587.
- 38 J. Oh, D. Jung, S. H. Oh, K. Roh, S. Ga and J. H. Lee, *J. CO₂ Util.*, 2019, **34**, 446.
- 39 A. Kirchofer, A. Brandt, S. Krevor, V. Prigiobbe and J. Wilcox, *Energy Environ. Sci.*, 2012, **5**(9), 8631.
- 40 S.-Y. Pan, L. L. Ana Maria and C. Pen-Chi, *Appl. Energy*, 2016, **170**, 269.
- 41 S. Ghasemi, G. Costa, D. Zingaretti, M. U. Bähler and R. Baciocchi, *Energy Procedia*, 2017, **114**, 5393.
- 42 A. Di Maria, R. Snellings, L. Alaerts, M. Quaghebeur and K. van Acker, *Int. J. Greenhouse Gas Control*, 2020, **93**, 102882.
- 43 ISO 14040:2006, *Environmental management — Life cycle assessment — Principles and framework*, 2006.
- 44 ISO 14044:2006, *Environmental management — Life cycle assessment — Requirements and guidelines*, 2006.
- 45 E. Benhelal, M. I. Rashid, C. Holt, M. S. Rayson, G. Brent, J. M. Hook, M. Stockenhuber and E. M. Kennedy, *J. Clean. Prod.*, 2018, **186**, 499.
- 46 N. von der Assen, J. Jung and A. Bardow, *Energy Environ. Sci.*, 2013, **6**(9), 2721.
- 47 A. Zimmerman, J. Wunderlich, G. Buchner, L. Müller, K. Armstrong, S. Michailos, A. Marxen, H. Naims, F. Mason, G. Stokes and E. Williams, *Techno-Economic Assessment & Life-Cycle Assessment Guidelines for CO₂ Utilization, Global CO₂ Initiative*, University of Michigan, 2018.
- 48 T. P. Bide, M. T. Styles and J. Naden, *Appl. Earth Sci.*, 2014, **123**(3), 179.
- 49 ASTM C150, *Standard Specification for Portland Cement C150/C150M*, 2017.
- 50 J. M. Paris, J. G. Roessler, C. C. Ferraro, H. D. DeFord and T. G. Townsend, *J. Clean. Prod.*, 2016, **121**, 1.
- 51 ISO 14067:2018, *Greenhouse gases - Carbon footprint of products - Requirements and guidelines for quantification*, 2018.
- 52 S. J. Gerdemann, W. K. O'Connor, D. C. Dahlin, L. R. Penner and H. Rush, *Environ. Sci. Technol.*, 2007, **41**(7), 2587.
- 53 E. Eikeland, A. B. Blichfeld, C. Tyrsted, A. Jensen and B. B. Iversen, *ACS Appl. Mater. Interfaces*, 2015, **7**(9), 5258.
- 54 I. Mouedhen, N. Kemache, L.-C. Pasquier, E. Cecchi, J.-F. Blais and G. Mercier, *J. Environ. Manage.*, 2017, **198**(Part 1), 1.
- 55 N. Kemache, L.-C. Pasquier, E. Cecchi, I. Mouedhen, J.-F. Blais and G. Mercier, *Fuel Process. Technol.*, 2017, **166**, 209.
- 56 S.-Y. Pan, P.-C. Chiang, Y.-H. Chen, C.-D. Chen, H.-Y. Lin and E.-E. Chang, *Environ. Sci. Technol.*, 2013, **47**(23), 13677.
- 57 S.-Y. Pan, Y.-H. Chen, C.-D. Chen, A.-L. Shen, M. Lin and P.-C. Chiang, *Environ. Sci. Technol.*, 2015, **49**(20), 12380.
- 58 I. Romão, E. Nduagu, J. Fagerlund, L. M. Gando-Ferreira and R. Zevenhoven, *Energy*, 2012, **41**(1), 203.



- 59 J. Fagerlund, E. Nduagu, I. Romão and R. Zevenhoven, *Energy*, 2012, **41**(1), 184.
- 60 A. Sanna, M. Dri and M. Maroto-Valer, *Fuel*, 2013, **114**, 153.
- 61 A. Sanna, J. Gaubert and M. M. Maroto-Valer, *Chem. Eng. J.*, 2016, **306**, 1049.
- 62 *GaBi 9.2, Software-System and Database for Life Cycle Engineering*, Thinkstep AG, Leinfelden-Echterdingen, Germany, 2019.
- 63 Swiss Centre for Life Cycle Inventories, *ecoinvent Data V 3.3*, 2016.
- 64 D. E. Highley, G. R. Chapman and K. A. Bonel, *The economic importance of minerals to the UK*, British Geological Survey, 2004.
- 65 L. Turri, M. Hervé, R. Keesjan, K. Pol and L. Francois, *Chem. Eng. Sci.*, 2017, **171**, 27.
- 66 R. M. Santos, P. C. M. Knops, K. L. Rijnsburger and Y. W. Chiang, *Frontiers in Energy Research*, 2016, **4**, 5.
- 67 D. Kremer, S. Etzold, J. Boldt, P. Blaum, K. M. Hahn, H. Wotruba and R. Telle, *Minerals*, 2019, **9**(8), 485.
- 68 S.-Y. Pan, P.-C. Chiang, Y.-H. Chen, C.-S. Tan and E.-E. Chang, *Environ. Sci. Technol.*, 2013, **47**(7), 3308.
- 69 World Steel Association, *Life Cycle Inventory Study*, 2018.
- 70 R. H. Perry and D. W. Green, *Perry's Chemical Engineers' Handbook*, McGraw-Hill, New York, 1997.
- 71 S. P. Veetil, G. Mercier, J.-F. Blais, E. Cecchi and S. Kentish, *Int. J. Miner. Process.*, 2015, **140**, 19.
- 72 T. Norgate and N. Haque, *J. Clean. Prod.*, 2010, **18**(3), 266.
- 73 K. Li, L. Wardhaugh, F. Paul, Y. Hai and T. Moses, *Appl. Energy*, 2016, **165**, 648.
- 74 M. Pehnt and J. Henkel, *Int. J. Greenhouse Gas Control*, 2009, **3**(1), 49.
- 75 F. A. Tobiesen, H. F. Svendsen and T. Mejdell, *Ind. Eng. Chem. Res.*, 2007, **46**(23), 7811.
- 76 N. von der Assen, L. J. Müller, A. Steingrube, P. Voll and A. Bardow, *Environ. Sci. Technol.*, 2016, **50**(3), 1093.
- 77 S. Martin, R. Inês and Z. Ron, *Energy*, 2013, **62**, 142.
- 78 A. Gamble, *Charlest. Advis.*, 2019, **20**(4), 46.
- 79 T. García-Segura, V. Yepes and J. Alcalá, *Int. J. Life Cycle Assess.*, 2014, **19**(1), 3.
- 80 N. Kemache, L.-C. Pasquier, E. Cecchi, I. Mouedhen, J.-F. Blais and G. Mercier, *Fuel Process. Technol.*, 2017, 209–216.
- 81 S. Reddy, J. Scherffius and S. Freguia, Fluor's Econamine FG PlusSM Technology: An Enhanced Amine-Based CO₂ Capture Process, *Second National Conference on Carbon Sequestration*, National Energy Technology Laboratory/Department of Energy, Alexandria, VA, May 2003, pp. 5–8.
- 82 S. E. Tanzer and A. Ramírez, *Energy Environ. Sci.*, 2019, **12**(4), 1210.
- 83 A.-H. A. Park and L.-S. Fan, *Chem. Eng. Sci.*, 2004, **59**(22), 5241.
- 84 J. Li and M. Hitch, *Miner. Eng.*, 2018, **128**, 69.
- 85 H. H. Khoo and R. B. H. Tan, *Environ. Prog.*, 2006, **25**(3), 208.
- 86 J. Artz, T. E. Müller, K. Thenert, J. Kleinekorte, R. Meys, A. Sternberg, A. Bardow and W. Leitner, *Chem. Rev.*, 2018, **118**(2), 434.
- 87 S. A. Miller, V. M. John, S. A. Pacca and A. Horvath, *Cem. Concr. Res.*, 2018, **114**, 115.
- 88 ASTM C595, *Standard Specification for Blended Hydraulic Cements C595/C595M*, 2017.
- 89 Z. Cao, L. Shen, A. N. Løvik, D. B. Müller and G. Liu, *Environ. Sci. Technol.*, 2017, **51**(19), 11468.

